

TMOS Switching

N-Channel — Enhancement

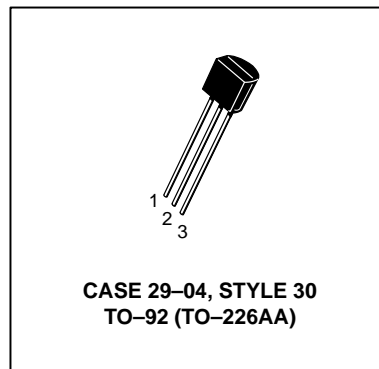
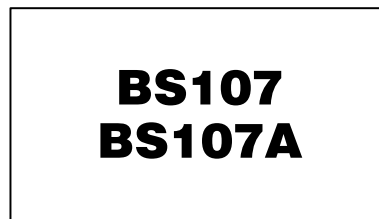
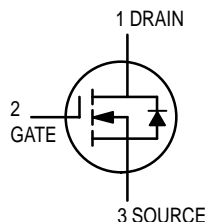

MAXIMUM RATINGS

Rating	Symbol	Value	Unit
Drain-Source Voltage	V_{DS}	200	Vdc
Gate-Source Voltage	V_{GS}	± 20	Vdc
— Continuous	V_{GS}	± 20	Vdc
— Non-repetitive ($t_p \leq 50 \mu s$)	V_{GSM}	± 30	Vpk
Drain Current			mAdc
Continuous ⁽¹⁾	I_D	250	
Pulsed ⁽²⁾	I_{DM}	500	
Total Device Dissipation @ $T_A = 25^\circ C$ Derate above $25^\circ C$	P_D	350	mW
Operating and Storage Junction Temperature Range	T_J, T_{stg}	-55 to 150	$^\circ C$

ELECTRICAL CHARACTERISTICS ($T_A = 25^\circ C$ unless otherwise noted)

Characteristic	Symbol	Min	Typ	Max	Unit
----------------	--------	-----	-----	-----	------

OFF CHARACTERISTICS

Zero-Gate-Voltage Drain Current ($V_{DS} = 130$ Vdc, $V_{GS} = 0$)	I_{DSS}	—	—	30	nAdc
Drain-Source Breakdown Voltage ($V_{GS} = 0$, $I_D = 100 \mu A$ dc)	$V_{(BR)DSX}$	200	—	—	Vdc
Gate Reverse Current ($V_{GS} = 15$ Vdc, $V_{DS} = 0$)	I_{GSS}	—	0.01	10	nAdc

ON CHARACTERISTICS⁽²⁾

Gate Threshold Voltage ($I_D = 1.0$ mAdc, $V_{DS} = V_{GS}$)	$V_{GS(Th)}$	1.0	—	3.0	Vdc
Static Drain-Source On Resistance	$r_{DS(on)}$				Ohms
BS107 ($V_{GS} = 2.6$ Vdc, $I_D = 20$ mAdc)		—	—	28	
($V_{GS} = 10$ Vdc, $I_D = 200$ mAdc)		—	—	14	
BS107A ($V_{GS} = 10$ Vdc)					
($I_D = 100$ mAdc)		—	4.5	6.0	
($I_D = 250$ mAdc)		—	4.8	6.4	

SMALL-SIGNAL CHARACTERISTICS

Input Capacitance ($V_{DS} = 25$ Vdc, $V_{GS} = 0$, $f = 1.0$ MHz)	C_{iss}	—	60	—	pF
Reverse Transfer Capacitance ($V_{DS} = 25$ Vdc, $V_{GS} = 0$, $f = 1.0$ MHz)	C_{rss}	—	6.0	—	pF
Output Capacitance ($V_{DS} = 25$ Vdc, $V_{GS} = 0$, $f = 1.0$ MHz)	C_{oss}	—	30	—	pF
Forward Transconductance ($V_{DS} = 25$ Vdc, $I_D = 250$ mAdc)	g_{fs}	200	400	—	mmhos

SWITCHING CHARACTERISTICS

Turn-On Time	t_{on}	—	6.0	15	ns
Turn-Off Time	t_{off}	—	12	15	ns

- The Power Dissipation of the package may result in a lower continuous drain current.
- Pulse Test: Pulse Width $\leq 300 \mu s$, Duty Cycle $\leq 2.0\%$.

RESISTIVE SWITCHING

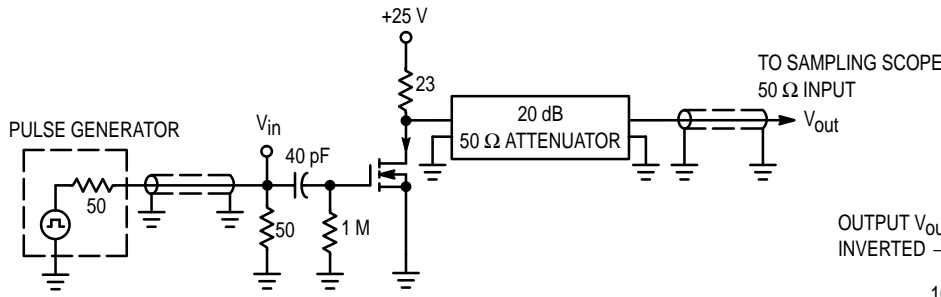

Figure 1. Switching Test Circuit

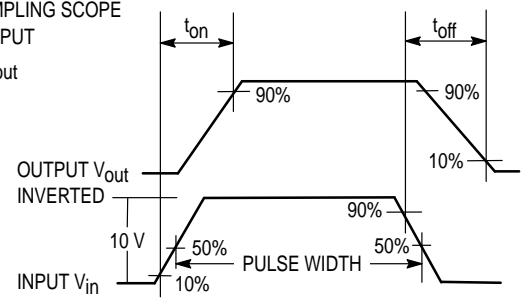

Figure 2. Switching Waveforms

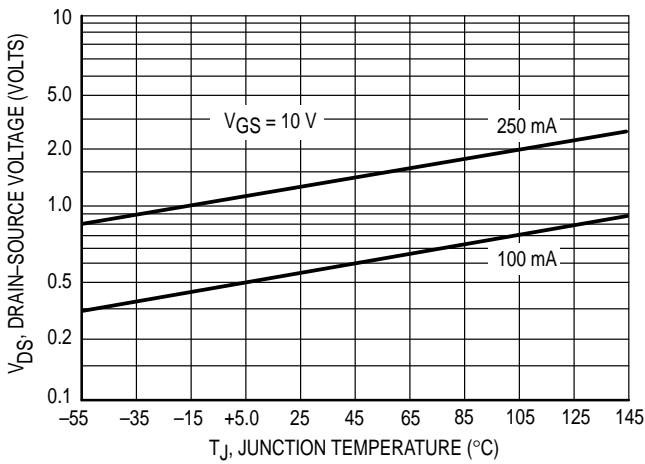

Figure 3. On Voltage versus Temperature

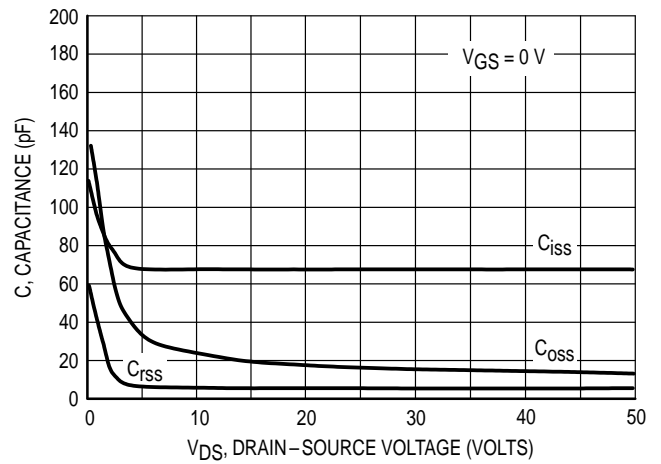

Figure 4. Capacitance Variation

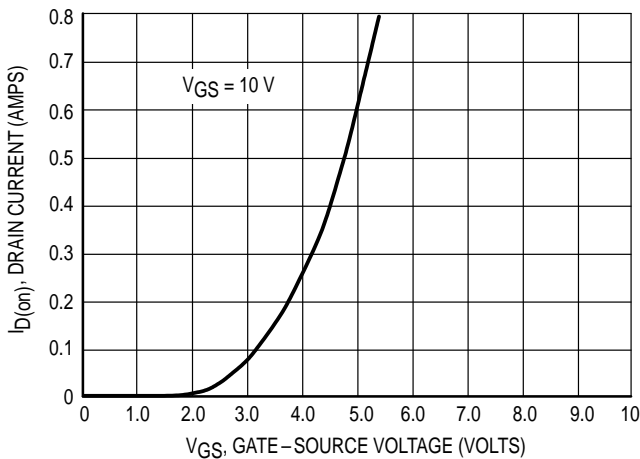

Figure 5. Transfer Characteristic

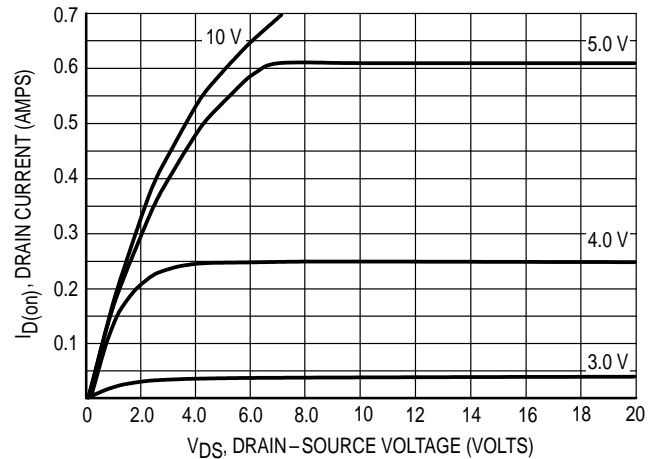

Figure 6. Output Characteristic

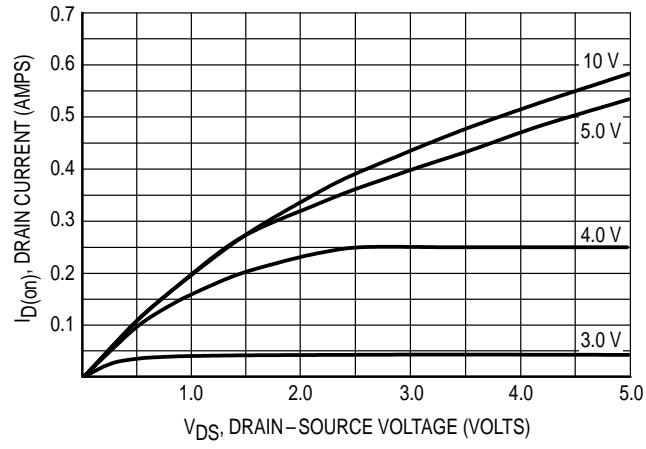
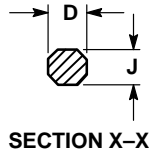
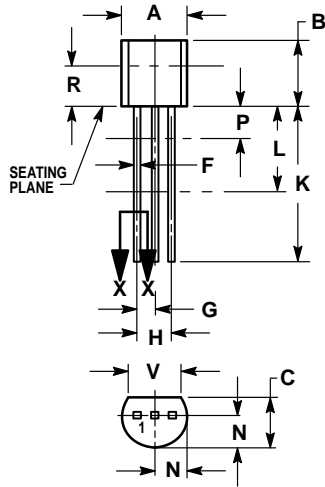

Figure 7. Saturation Characteristic

PACKAGE DIMENSIONS



NOTES:

1. DIMENSIONING AND TOLERANCING PER ANSI Y14.5M, 1982.
2. CONTROLLING DIMENSION: INCH.
3. CONTOUR OF PACKAGE BEYOND DIMENSION R IS UNCONTROLLED.
4. DIMENSION F APPLIES BETWEEN P AND L. DIMENSION D AND J APPLY BETWEEN L AND K MINIMUM. LEAD DIMENSION IS UNCONTROLLED IN P AND BEYOND DIMENSION K MINIMUM.

DIM	INCHES		MILLIMETERS	
	MIN	MAX	MIN	MAX
A	0.175	0.205	4.45	5.20
B	0.170	0.210	4.32	5.33
C	0.125	0.165	3.18	4.19
D	0.016	0.022	0.41	0.55
F	0.016	0.019	0.41	0.48
G	0.045	0.055	1.15	1.39
H	0.095	0.105	2.42	2.66
J	0.015	0.020	0.39	0.50
K	0.500	—	12.70	—
L	0.250	—	6.35	—
N	0.080	0.105	2.04	2.66
P	—	0.100	—	2.54
R	0.115	—	2.93	—
V	0.135	—	3.43	—

CASE 029-04
(TO-226AA)
ISSUE AD

STYLE 30:

- PIN 1. DRAIN
2. GATE
3. SOURCE

Motorola reserves the right to make changes without further notice to any products herein. Motorola makes no warranty, representation or guarantee regarding the suitability of its products for any particular purpose, nor does Motorola assume any liability arising out of the application or use of any product or circuit, and specifically disclaims any and all liability, including without limitation consequential or incidental damages. "Typical" parameters which may be provided in Motorola data sheets and/or specifications can and do vary in different applications and actual performance may vary over time. All operating parameters, including "Typicals" must be validated for each customer application by customer's technical experts. Motorola does not convey any license under its patent rights nor the rights of others. Motorola products are not designed, intended, or authorized for use as components in systems intended for surgical implant into the body, or other applications intended to support or sustain life, or for any other application in which the failure of the Motorola product could create a situation where personal injury or death may occur. Should Buyer purchase or use Motorola products for any such unintended or unauthorized application, Buyer shall indemnify and hold Motorola and its officers, employees, subsidiaries, affiliates, and distributors harmless against all claims, costs, damages, and expenses, and reasonable attorney fees arising out of, directly or indirectly, any claim of personal injury or death associated with such unintended or unauthorized use, even if such claim alleges that Motorola was negligent regarding the design or manufacture of the part. Motorola and are registered trademarks of Motorola, Inc. Motorola, Inc. is an Equal Opportunity/Affirmative Action Employer.

Mfax is a trademark of Motorola, Inc.

How to reach us:

USA/EUROPE/Locations Not Listed: Motorola Literature Distribution;
P.O. Box 5405, Denver, Colorado 80217. 303-675-2140 or 1-800-441-2447

JAPAN: Nippon Motorola Ltd.; Tatsumi-SPD-JLDC, 6F Seibu-Butsuryu-Center,
3-14-2 Tatsumi Koto-Ku, Tokyo 135, Japan. 81-3-3521-8315

Mfax™: RMFAX0@email.sps.mot.com – TOUCHTONE 602-244-6609
– US & Canada ONLY 1-800-774-1848

ASIA/PACIFIC: Motorola Semiconductors H.K. Ltd.; 8B Tai Ping Industrial Park,
51 Ting Kok Road, Tai Po, N.T., Hong Kong. 852-26629298

INTERNET: <http://motorola.com/sps>

