

PLEASE CHECK WWW.MOLEX.COM FOR LATEST PART INFORMATION

Part Number: [0416810046](#)
Status: **Active**
Description: 3.96mm (.156") Pitch KK® Header, Breakaway, Vertical, Polarizing Wall, 24 Circuits, 0.76µm (30µ") Gold (Au) Selective Plating

Documents:

[3D Model](#) [Product Specification PS-08-50 \(PDF\)](#)
[Drawing \(PDF\)](#) [RoHS Certificate of Compliance \(PDF\)](#)
[Packaging Specification \(PDF\)](#)

Agency Certification

CSA LR19980
 UL E29179

General

Product Family PCB Headers
 Series [41681](#)
 Application Wire-to-Board
 Product Name KK®

Physical

Breakaway Yes
 Circuits (Loaded) 24
 Circuits (maximum) 24
 Color - Resin Black
 Durability (mating cycles max) 50
 Flammability 94V-0
 Glow-Wire Compliant No
 Lock to Mating Part None
 Material - Metal Brass
 Material - Plating Mating Gold
 Material - Resin Polyester
 Number of Rows 1
 Orientation Vertical
 PC Tail Length (in) 0.172 In
 PC Tail Length (mm) 4.37 mm
 PCB Locator No
 PCB Retention None
 PCB Thickness Recommended (in) 0.062 In
 PCB Thickness Recommended (mm) 1.60 mm
 Packaging Type Bag
 Pitch - Mating Interface (in) 0.156 In
 Pitch - Mating Interface (mm) 3.96 mm
 Plating min: Mating (µin) 30
 Plating min: Mating (µm) 0.76
 Polarized to Mating Part No
 Polarized to PCB No
 Shrouded No
 Stackable No
 Temperature Range - Operating 0°C to +75°C
 Termination Interface: Style Through Hole

Electrical

Current - Maximum per Contact 7A
 Voltage - Maximum 250V

Solder Process Data

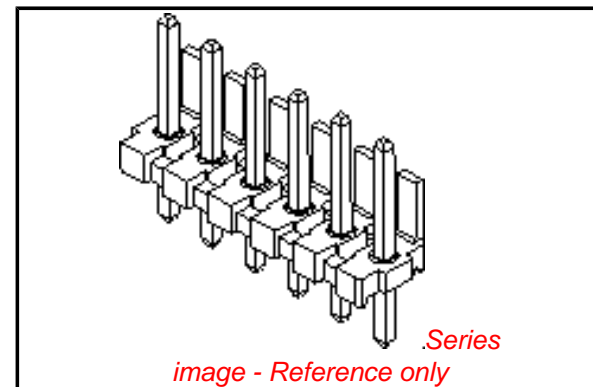

EU RoHS

ELV and RoHS Compliant
REACH SVHC Contains SVHC: No
Halogen-Free Status
Not Reviewed

China RoHS



Need more information on product environmental compliance?

Email productcompliance@molex.com
 For a multiple part number RoHS Certificate of Compliance, [click here](#)

Please visit the [Contact Us](#) section for any non-product compliance questions.

Search Parts in this Series

[41681Series](#)

Mates With

[3069](#) , [2139](#) , [2145](#) , [6442](#) , [7674](#) , [7675](#) , [41695](#) , L ink:41815

Duration at Max. Process Temperature (seconds)	5
Lead-free Process Capability	Wave Capable (TH only)
Max. Cycles at Max. Process Temperature	1
Process Temperature max. C	230

Material Info

Old Part Number	A-41681-B24228
-----------------	----------------

Reference - Drawing Numbers

Product Specification	PS-08-50
Sales Drawing	SD-41681-001

This document was generated on 04/12/2010

PLEASE CHECK WWW.MOLEX.COM FOR LATEST PART INFORMATION

13 12 11 10 9 8 7 6 5 4 3 2 1

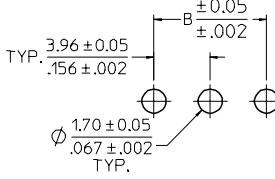
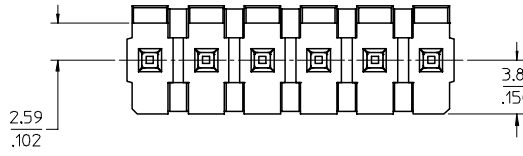
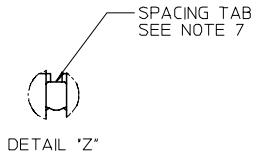

PCB LAYOUT: COMPONENT SIDE
RECOMMENDED PCB THICKNESS:
1.57 ± 0.18 / .062 ± .007

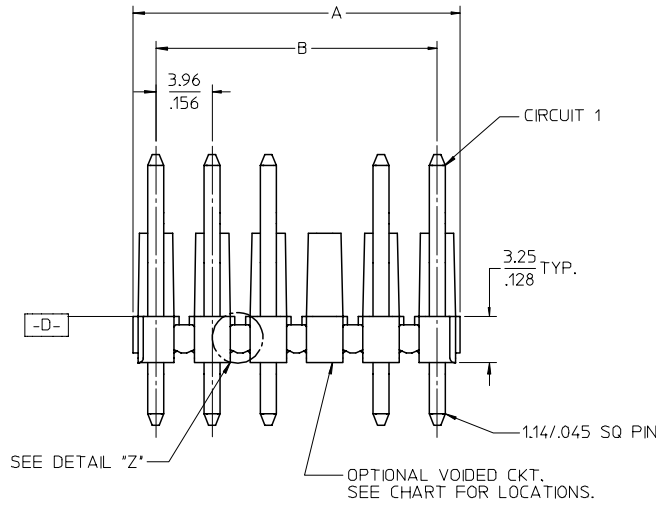
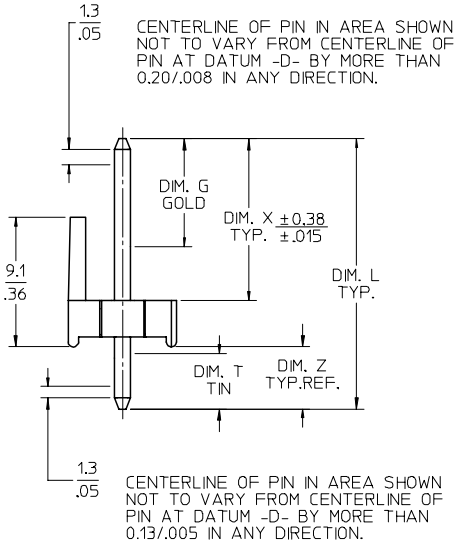

- NOTES:
1. MATERIAL: HEADER: GLASS FILLED POLYESTER, 94V-0, MOLDED BLACK PINS- BRASS
2. FINISH:
(102) = OVERALL TIN: (0.00508)/.000200 MIN.
OVERALL COPPER UNDERCOAT: (0.00254)/.000100 MIN.
(208) = SELECT GOLD: (0.00038)/.000015 MIN. OVER
SELECT TIN: (0.00254)/.000100 MIN. OVER
NICKEL OVERALL: (0.000127)/.000050 MIN.
(228) = SELECT GOLD: (0.00076)/.000030 MIN.
SELECT TIN: (0.00254)/.000100 MIN.
OVER NICKEL OVERALL: (0.00127)/.000050 MIN.
(501) = OVERALL GOLD: (0.00051)/.000020 MIN.
OVER NICKEL OVERALL: (0.00076)/.000030 MIN.
(503) = OVERALL GOLD: (0.00076)/.000030 MIN.
OVER NICKEL OVERALL: (0.00127)/.000050 MIN.

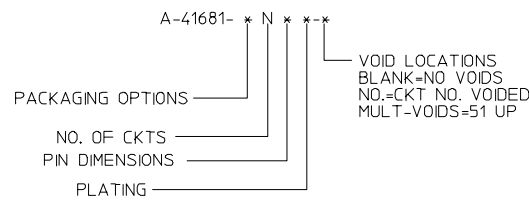

CIRCUIT	A	B
2	6.78/7.87 .267/.310	3.96 .156
3	10.74/11.84 .423/.466	7.92 .312
4	14.71/15.80 .579/.622	11.89 .468
5	18.67/19.76 .735/.778	15.85 .624
6	22.63/23.72 .891/.934	19.81 .780
7	26.59/27.69 1.047/1.090	23.77 .936
8	30.56/31.65 1.203/1.246	27.74 1.092
9	34.52/35.61 1.359/1.402	31.70 1.248
10	38.48/39.57 1.515/1.558	35.66 1.404
11	42.44/43.54 1.671/1.714	39.62 1.560
12	46.41/47.50 1.827/1.870	43.59 1.716
13	50.37/51.46 1.983/2.026	47.55 1.872
14	54.33/55.42 2.139/2.182	51.51 2.028
15	58.29/59.39 2.295/2.338	55.47 2.184
16	62.26/63.35 2.451/2.494	59.44 2.340
17	66.22/67.31 2.607/2.650	63.40 2.496
18	70.18/71.27 2.763/2.806	67.36 2.652
19	74.14/75.23 2.919/2.962	71.32 2.808
20	78.11/79.20 3.075/3.118	75.29 2.964
21	82.07/83.16 3.231/3.274	79.25 3.120
22	86.03/87.12 3.387/3.430	83.21 3.276
23	89.94/91.08 3.541/3.586	87.17 3.432
24	93.85/95.00 3.695/3.740	91.14 3.588

2-*	S2
1	S2
SHT.	REV.

- * THE PRIMARY SHIPPING CARTON WILL BE LABELED "COMPLIANT TO RoHS DIRECTIVE 2002/95/EC AND ELV ANNEX II OF DIRECTIVE 2000/53/EC". CARTONS WITHOUT MAY CONTAIN PRODUCT WITH TIN/LEAD PLATINGS.
3. PRODUCT SPECIFICATION: PS-08-50.
4. PACKAGING: SEE CHART
5. SOLDERABILITY: PER SMES-152.
6. PIN PUSH-OUT FORCE: PRIOR TO SOLDERING, A 3 LB. MINIMUM FORCE IN EITHER DIRECTION SHALL BE REQUIRED TO PUSH THE PIN OUT OF THE HEADER.
7. PARTS ARE STACKABLE END TO END ON 3.96/.156 CENTERS. (SPACING TABS MUST BE REMOVED ON CIRCUIT SIZES 1-23 BEFORE PARTS ARE STACKABLE.)

REVISIONS:
REVISED / REDRAWN
EC NO: UCP2006-2983
DRAWN/PRI/DDR 2006/08/02
CHKD:ADERR 2006/08/03
APPR:FSM/TH 2006/08/04

QUALITY SYMBOLS:
=0
=0

DESCRIPTION:
S2

GENERAL TOLERANCES (UNLESS SPECIFIED)	
mm	INCH
4 PLACES ± ---	± ---
3 PLACES ± ---	± .006
2 PLACES ± 0.15	± .010
1 PLACE ± 0.25	± ---
ANGULAR ±1/2°	

DRAFT WHERE APPLICABLE MUST REMAIN WITHIN DIMENSIONS

DIMENSION STYLE	
MM/IN	SCALE
DRAWN BY: SAMIEC	DATE: 08/09/85
CHECKED BY: PATEL	DATE: 08/09/85
APPROVED BY: LENZ	DATE: 08/09/85
MATERIAL NO.:	DOCUMENT NO.:

SCALE: 4:1
DESIGN UNITS: INCH
THIRD ANGLE PROJECTION

FILE: KK .156 HEADER ASSEMBLY POLARIZING STRAIGHT 2-24 CKTS.

MOLEX INCORPORATED

SEE CHART SD-41681-001

SHEET NO. 1 OF *

THIS DRAWING CONTAINS INFORMATION THAT IS PROPRIETARY TO MOLEX INCORPORATED AND SHOULD NOT BE USED WITHOUT WRITTEN PERMISSION

12 11 10 9 8 7 6 5 4 3 2 1

ENG. NO: A-41681-ANA102-*				ENG. NO: A-41681-ANA501-*				ENG. NO: A-41681-ANC102-*			
PIN NUMBER		2161-1(102)		PIN NUMBER		2161-1(501)		PIN NUMBER		2161-56(102)	
PLATING		102		PLATING		501		PLATING		102	
DIM. L		(19.05)/.750		DIM. L		(19.05)/.750		DIM. L		(17.86)/.703	
DIM. X		(11.43)/.450		DIM. X		(11.43)/.450		DIM. X		(11.43)/.450	
DIM. G (GOLD)		N/A		DIM. G (GOLD)		OVERALL		DIM. G (GOLD)		N/A	
DIM. Z		(4.37)/.172		DIM. Z		(4.37)/.172		DIM. Z		(3.18)/.125	
DIM. T (TIN)		OVERALL		DIM. T (TIN)		N/A		DIM. T (TIN)		OVERALL	
PACKAGING		PK-41681-001 (BULK)		PACKAGING		PK-41681-001 (BULK)		PACKAGING		PK-41681-001 (BULK)	
CKTS	EDP NO.	ENG. NO.	VOIDS	CKTS	EDP NO.	ENG. NO.	VOIDS	CKTS	EDP NO.	ENG. NO.	VOIDS
02	26-48-1023	A-41681-A2A102		02	26-48-2023	A-41681-A2A501		02	26-48-7025	A-41681-A2C102	
03	26-48-1033	A-41681-A3A102		03	26-48-2033	A-41681-A3A501		03	26-48-7035	A-41681-A3C102	
04	26-48-1043	A-41681-A4A102		04	26-48-2043	A-41681-A4A501		04	26-48-7045	A-41681-A4C102	
05	26-48-1053	A-41681-A5A102		05	26-48-2053	A-41681-A5A501		05	26-48-7055	A-41681-A5C102	
06	26-48-1063	A-41681-A6A102		06	26-48-2063	A-41681-A6A501		06	26-48-7065	A-41681-A6C102	
07	26-48-1073	A-41681-A7A102		07	26-48-2073	A-41681-A7A501		07	26-48-7075	A-41681-A7C102	
08	26-48-1083	A-41681-A8A102		08	26-48-2083	A-41681-A8A501		08	26-48-7085	A-41681-A8C102	
09	26-48-1093	A-41681-A9A102		09	26-48-2093	A-41681-A9A501		09	26-48-7095	A-41681-A9C102	
10	26-48-1103	A-41681-A10A102		10	26-48-2103	A-41681-A10A501		10	26-48-7105	A-41681-A10C102	
11	26-48-1113	A-41681-A11A102		11	26-48-2113	A-41681-A11A501		11	26-48-7115	A-41681-A11C102	
12	26-48-1123	A-41681-A12A102		12	26-48-2123	A-41681-A12A501		12	26-48-7125	A-41681-A12C102	
13	26-48-1133	A-41681-A13A102		13	26-48-2133	A-41681-A13A501		13	26-48-7135	A-41681-A13C102	
14	26-48-1143	A-41681-A14A102		14	26-48-2143	A-41681-A14A501		14	26-48-7145	A-41681-A14C102	
15	26-48-1153	A-41681-A15A102		15	26-48-2153	A-41681-A15A501		15	26-48-7155	A-41681-A15C102	
16	26-48-1163	A-41681-A16A102		16	26-48-2163	A-41681-A16A501		16	26-48-7165	A-41681-A16C102	
17	26-48-1173	A-41681-A17A102		17	26-48-2173	A-41681-A17A501		17	26-48-7175	A-41681-A17C102	
18	26-48-1183	A-41681-A18A102		18	26-48-2183	A-41681-A18A501		18	26-48-7185	A-41681-A18C102	
19	26-48-1193	A-41681-A19A102		19	26-48-2193	A-41681-A19A501		19	26-48-7195	A-41681-A19C102	
20	26-48-1203	A-41681-A20A102		20	26-48-2203	A-41681-A20A501		20	26-48-7205	A-41681-A20C102	
21	26-48-1213	A-41681-A21A102		21	26-48-2213	A-41681-A21A501		21	26-48-7215	A-41681-A21C102	
22	26-48-1223	A-41681-A22A102		22	26-48-2223	A-41681-A22A501		22	26-48-7225	A-41681-A22C102	
23	26-48-1233	A-41681-A23A102		23	26-48-2233	A-41681-A23A501		23	26-48-7235	A-41681-A23C102	
24	26-48-1243	A-41681-A24A102		24	26-48-2243	A-41681-A24A501		24	26-48-7245	A-41681-A24C102	
13	26-49-6137	A-41681-A13A102-12	12								
17	26-49-6177	A-41681-A17A102-2	2								
20	26-49-6207	A-41681-A20A102-17	17								

S2	REV:	<u>ECR/ECN INFORMATION</u>	<u>TITLE:</u>	KK .156 HEADER ASSEMBLY POLARIZING STRAIGHT 2-24 CKTS	<u>SHEET No.</u>
		EC No: UCP2006-2983			- 2 -
		DATE: 2006-06-13			
<u>DOCUMENT NUMBER:</u>		<u>CREATED / REVISED BY:</u>	<u>CHECKED BY:</u>	<u>APPROVED BY:</u>	
SD-41681-001		PRIDDER	ADERR	FSMITH	

