

450-1812 Solder mount, through hole socket, for .065 (1,65) diameter pins

Recommended mounting hole .102 (2,59) ±.002 (0,05), #38 drill

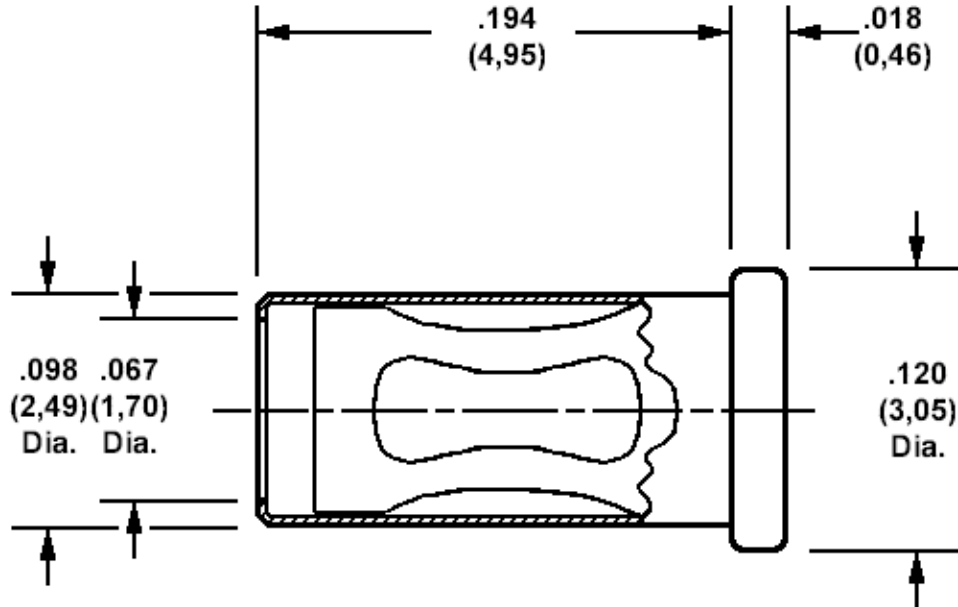

Through hole .067 (1,70)

How to order code
450-1812-01-XX-00
Basic Part No XX = Finish

MATERIALS				
Component	Material	Finish(-03)	Finish(-04)	Finish(-06)
Body	Brass	Gold over Nickel	Tin	Tin
Spring	Beryllium copper	Gold over Nickel	Tin	Gold over Nickel