

# LDC-120 Series

## Compact, LED, 150W Constant Current AC/DC Power Supply



### Key Features:

- 150W Output Power
- UL 8750 Approved
- Constant Current Output
- Active PFC
- 90 - 305 VAC Input
- IP65 / IP67 Rated
- Meets EN 55015, EN 61547
- Dimming Function
- >50 kHour Life Expectancy
- Lightning Surge Protection
- Over Volt/Temp Protection



### MicroPower Direct

292 Page Street  
Suite D  
Stoughton, MA 02072  
USA

T: (781) 344-8226

F: (781) 344-8481

E: sales@micropowerdirect.com

W: www.micropowerdirect.com



### Electrical Specifications

Specifications typical @ +25°C, 230 VAC input voltage & rated output current, unless otherwise noted. Specifications subject to change without notice.



#### Input

Parameter	Conditions	Min.	Typ.	Max.	Units
Input Voltage Range		90		305	VAC
		127		431	VDC
Input Frequency		47		63	Hz
Inrush Current, See Note 1	230 VAC		75		A Pk
	115 VAC		1.60		
Input Current	230 VAC		0.80		A
	264 VAC		0.70		
Power Factor Correction		0.98 @ 115 VAC			
		0.95 @ 230 VAC			
		0.93 @ 264 VAC			
Total Harmonic Distortion (THD)	See Note 2		10		%
Turn On Delay, See Note 3	115 VAC		1.5		S
	230 VAC		0.5		
Leakage Current	277 VAC			0.75	mA

#### Output

Parameter	Conditions	Min.	Typ.	Max.	Units
Output Current Accuracy			±5.0		%
Line Regulation	V <sub>IN</sub> = Min to Max		±1.0		%
Ripple & Noise (20 MHz)	See Note 4		2.0		V <sub>P-P</sub>
Output Ripple Current			±5.0		%
Hold-Up Time	115 VAC	12.0			mS
Over Temperature Protection	±10%, Autorecovery		85		°C
Short Circuit Protection	Continuous (Autorecovery)				
Overload Protection	Autorecovery	95		107	%I <sub>OUT</sub>

#### General

Parameter	Conditions	Min.	Typ.	Max.	Units
Isolation Voltage, 60S	Input to Output	3,750			
	Input to FG	2,000			VAC
	Output to FG	500			
Insulation Resistance	Input to Output	100 MΩ / 500 VDC / 25°C / 70% RH			
	Input to FG Output to FG				

#### EMI Characteristics

Parameter	Standard
EMI	EN 55015; EN 6100-3-2, -3; FCC Part 18; CNS 14115; GB 17743
EMS	EN 61547; EN 61000-4-2,-3, -4, -5, -6, -8, -11; GB 17625.1
Surge	10 kV (L/N - FG), 5 kV (L-N)/1.2 x 50 μS

#### Environmental

Parameter	Conditions	Min.	Typ.	Max.	Units
Operating Temperature Range	Ambient	-40	+25	+70	°C
Storage Temperature Range		-40		+85	°C
Cooling	Free Air Convection (See Derating Curve on Page 2)				
Humidity	RH, Non-condensing			95	%

#### Physical

Case Size	See Mechanical Diagrams (Page 4)
Weight	32.1 Oz (950g)

#### Reliability Specifications

Parameter	Conditions	Min.	Typ.	Max.	Units
MTBF	MIL HDBK 217F, 25°C, Gnd Benign	220			kHours
Life Expectancy	See Note 5	50			kHours
Safety Standards	UL 8750 Approved, Meets EN 61347, GB 19510.1, GB 19510.14				
Vibration	5 - 500 Hz, 1G, 1 Oct/Min, 2 Cycles, Period for 75 Min. Each Along X, Y, & Z Axis				

[www.micropowerdirect.com](http://www.micropowerdirect.com)

Model Number	Output				Output Power (W)	Efficiency (% Typ)
	Current		Voltage Range (VDC)	OVP Level (VDC)		
	Max (mA)	Adj. Range (mA)				
LDC-120-0350 x	350	210 - 350	210 - 430	475 - 495	150	92
LDC-120-0500 x	500	300 - 500	150 - 300	335 - 355	150	92
LDC-120-0700 x	700	420 - 700	107 - 215	230 - 240	150	92
LDC-120-1050 x	1,050	630 - 1,500	74 - 148	165 - 175	155	92
LDC-120-1400 x	1,400	840 - 1,400	54 - 108	120 - 130	151	92
LDC-120-2100 x	2,100	1,260 - 2,100	31 - 58	62 - 80	122	91
LDC-120-2450 x	2,450	1,470 - 2,450	36 - 49	54 - 73	120	91
LDC-120-2800 x	2,800	1,680 - 2,800	31 - 42	49 - 65	122	91
LDC-120-3500 x	3,500	2,100 - 3,500	26 - 35	41 - 55	122	91
LDC-120-4550 x	4,550	2,730 - 4,550	21 - 27	31 - 37	123	90

Notes:

1. Inrush current is given for a cold start at 25°C.
2. Total Harmonic Distortion (THD) is specified with an input of 230 VAC/50 Hz at full load.
3. Turn on delay is specified at full load.
4. Ripple & noise is measured at 20 MHz. Connection to the unit is made with a 0.1 µF ceramic capacitor and a 22 µF electrolytic capacitor connected in parallel.
5. Life expectancy is calculated at 230 VAC, full load and a case temp of +70°C.
6. Recovery from an over voltage fault is automatic.

Package Type

Model	Ingress Protection	Dimming Function
LDC-120-xxxx A	IP65	Adjust by internal, variable resistor
LDC-120-xxxx B	IP67	Adjust by external resistor, DC voltage level or PWM signal

Derating Curve: Temperature

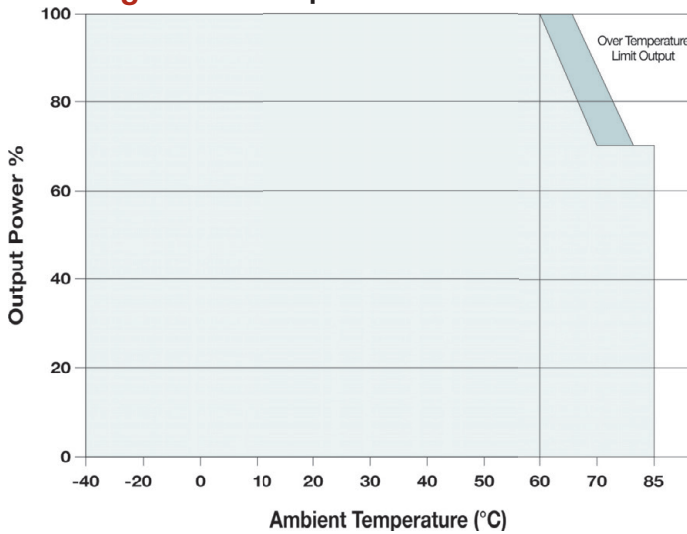

Derating Curve: Input Voltage

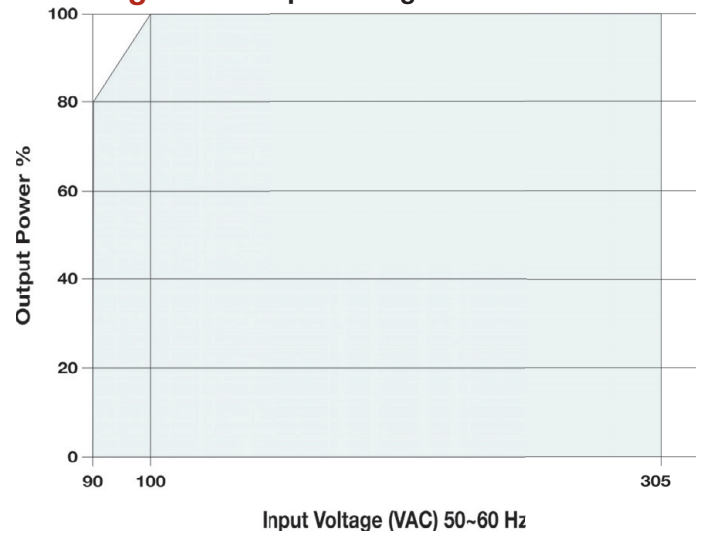

Efficiency vs Load: LDC-120-3500

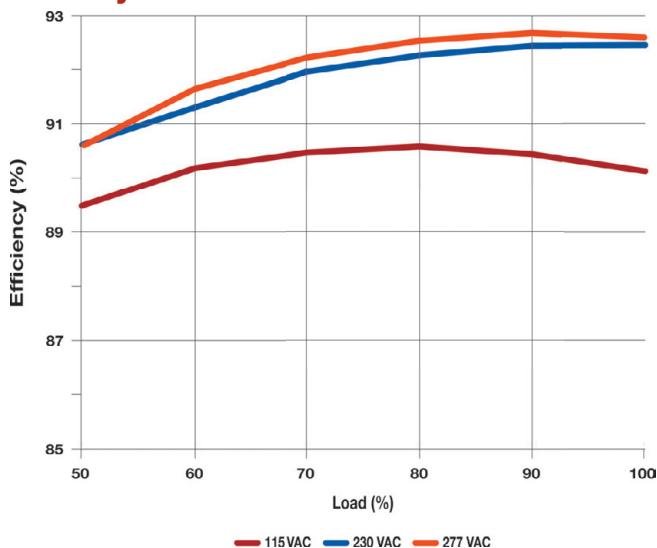

PFC vs Load: LDC-120-3500

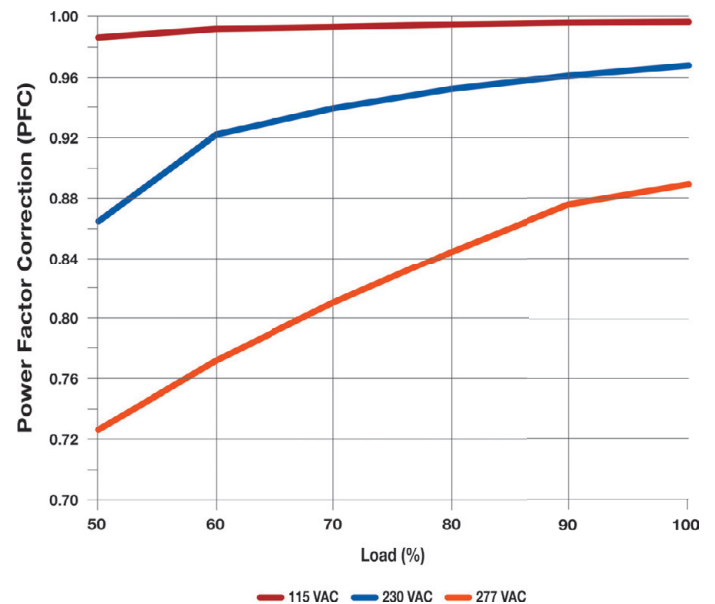

**Functional Block Diagram**

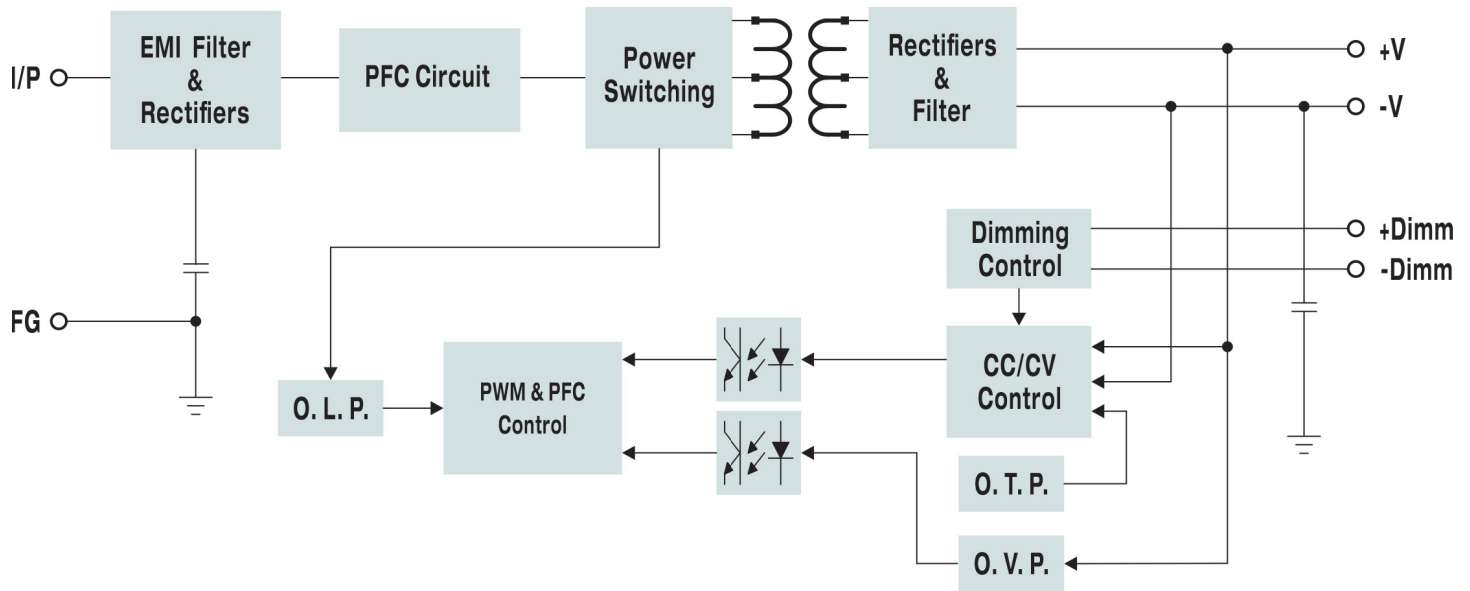

**Dimming Mode: B Model**

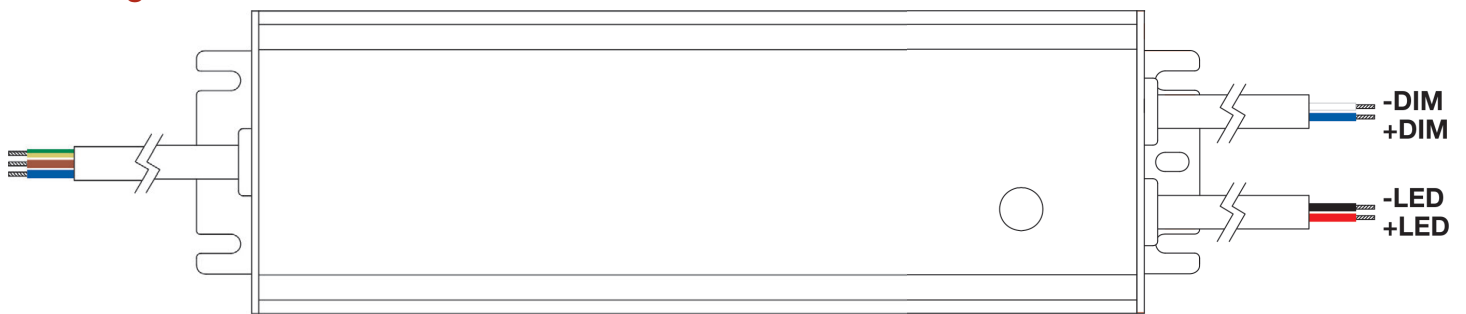

With the LDC-120 "B" model, the output current level can be adjusted (Dimmed) by three different methods; Resistive, Analog or Digital. Adjustments are made using the +DIM and -DIM inputs.

**Resistive:** Connect a 0.1 to 10 kΩ resistor between the DIM+ (Blue) and DIM- (White) wires

Input Frequency	10 kΩ	20 kΩ	30 kΩ	40 kΩ	50 kΩ	60 kΩ	70 kΩ	80 kΩ	90 kΩ	100 kΩ	Open
Percentage of Rated Current	10%	20%	30%	40%	50%	60%	70%	80%	90%	100%	95~105%

**Analog:** Apply 1 VDC to 10 VDC level between the DIM+ (Blue) and DIM- (White) wires

Adjust Voltage	1 VDC	2 VDC	3 VDC	4 VDC	5 VDC	6 VDC	7 VDC	8 VDC	9 VDC	10 VDC	Open
Percentage of Rated Current	10%	20%	30%	40%	50%	60%	70%	80%	90%	100%	95~105%

**Digital:** Apply a PWM signal (100 Hz - 3 kHz) between the DIM+ (Blue) and DIM- (White) wires

Duty Cycle	10%	20%	30%	40%	50%	60%	70%	80%	90%	100%	Open
Percentage of Rated Current	10%	20%	30%	40%	50%	60%	70%	80%	90%	100%	95~105%

**Notes:**

1. The -DIM (White) and -LED (Black) wires should not be connected.
2. The Dimming function will not turn the lighting fixture totally off. For more info on how to do this, please contact the factory

## Mechanical Dimensions: A Model

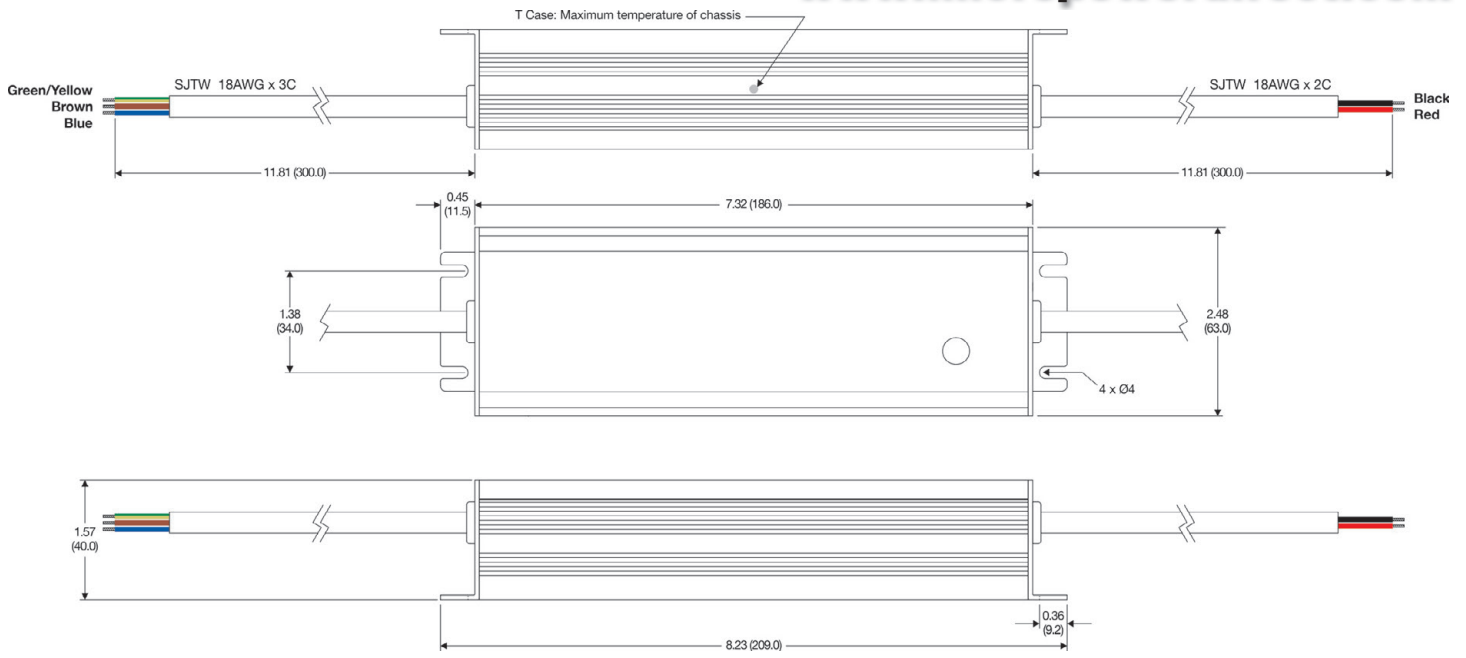

### Wire Connections: Input

Color	Function
Green/Yellow	Field Ground
Brown	AC-Line
Blue	AC-Neutral

### Wire Connections: Output

Color	Function
Black	-LED
Red	+LED

## Mechanical Dimensions: B Model (Dimming Function)

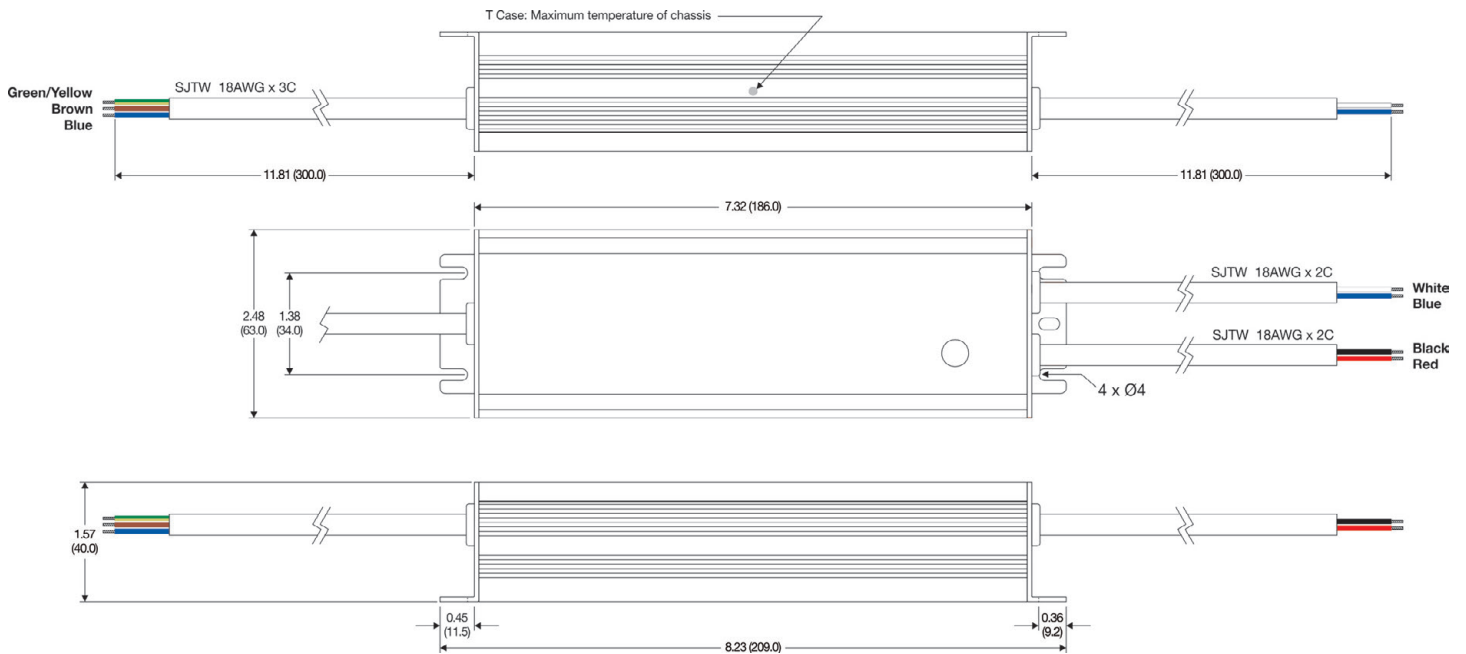

### Wire Connections: Input

Color	Function
Green/Yellow	Field Ground
Brown	AC-Line
Blue	AC-Neutral

### Wire Connections: Output

Color	Function
White	-DIM
Blue	+DIM
Black	-LED
Red	+LED



**MicroPower Direct**  
We Power Your Success - For Less!