

RF CHIP INDUCTORS

Wire Wound - 0805 Series

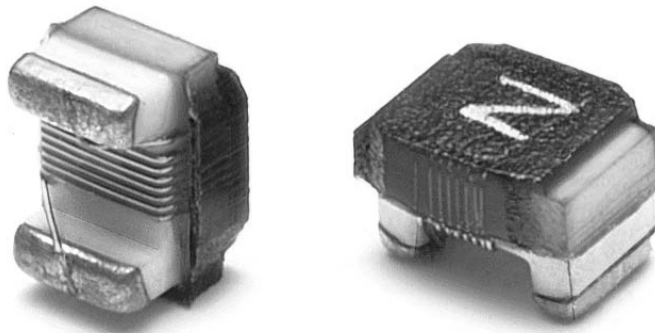





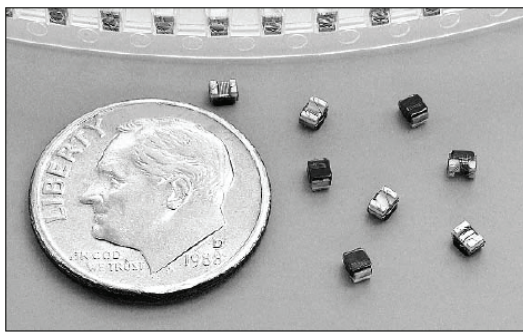

For More Information Please Visit: Networking.PulseElectronics.com

WIRE WOUND RF CHIP INDUCTORS

0805CD SERIES



-  Wire wound ceramic core construction
-  High Q values
-  High self resonant frequency
-  Temperature Range -40°C to +125°C
-  Industry 0805 (2012) size and surface mount land pattern
-  100% Tin Solder Termination

Electrical Specifications @ 25°C - Operating Temperature Range -40 °C to +125°C

Part Number Tolerance +/-2%	Part Number Tolerance +/-5%	Inductance ¹ (nH)	Q ² (MIN)	SRF ³ (MHz MIN)	Rdc ⁴ (Ω MAX)	I _{dc} ⁵ (mA MAX)
PE-0805CD030GTT	PE-0805CD030JTT	3.32 @ 250MHz	40 @ 1500MHz	6000	0.08	600
PE-0805CD050GTT	PE-0805CD050JTT	5.6 @ 250MHz	50 @ 1500MHz	5500	0.10	600
PE-0805CD080GTT	PE-0805CD080JTT	7.9 @ 250MHz	50 @ 1000MHz	4700	0.12	600
PE-0805CD100GTT	PE-0805CD100JTT	10.2 @ 250MHz	50 @ 500MHz	4100	0.14	600
PE-0805CD120GTT	PE-0805CD120JTT	11.9 @ 250MHz	50 @ 500MHz	4000	0.15	600
PE-0805CD150GTT	PE-0805CD150JTT	14.9 @ 250MHz	50 @ 500MHz	3400	0.17	600
PE-0805CD180GTT	PE-0805CD180JTT	17.95 @ 250MHz	50 @ 500MHz	3300	0.20	600
PE-0805CD220GTT	PE-0805CD220JTT	21.7 @ 250MHz	55 @ 500MHz	2600	0.22	500
PE-0805CD270GTT	PE-0805CD270JTT	26.5 @ 250MHz	55 @ 500MHz	2500	0.25	500
PE-0805CD330GTT	PE-0805CD330JTT	32.75 @ 250MHz	60 @ 500MHz	2050	0.27	500
PE-0805CD390GTT	PE-0805CD390JTT	38.5 @ 250MHz	60 @ 500MHz	2000	0.29	500
PE-0805CD470GTT	PE-0805CD470JTT	46.6 @ 200MHz	60 @ 500MHz	1650	0.31	500
PE-0805CD560GTT	PE-0805CD560JTT	55.5 @ 200MHz	60 @ 500MHz	1550	0.34	500
PE-0805CD680GTT	PE-0805CD680JTT	67.8 @ 200MHz	60 @ 500MHz	1450	0.38	500
PE-0805CD820GTT	PE-0805CD820JTT	82.7 @ 150MHz	60 @ 500MHz	1300	0.42	400
PE-0805CD101GTT	PE-0805CD101JTT	98.7 @ 150MHz	60 @ 500MHz	1200	0.46	400
PE-0805CD111GTT	PE-0805CD111JTT	110 @ 150MHz	50 @ 250MHz	1000	0.48	400
PE-0805CD121GTT	PE-0805CD121JTT	119.7 @ 150MHz	50 @ 250MHz	1100	0.51	400
PE-0805CD151GTT	PE-0805CD151JTT	149.4 @ 100MHz	50 @ 250MHz	920	0.56	400
PE-0805CD181GTT	PE-0805CD181JTT	179.6 @ 100MHz	50 @ 250MHz	870	0.64	400
PE-0805CD221GTT	PE-0805CD221JTT	217 @ 100MHz	45 @ 250MHz	850	0.70	400
PE-0805CD271GTT	PE-0805CD271JTT	269 @ 100MHz	45 @ 250MHz	650	1.00	350
PE-0805CD331GTT	PE-0805CD331JTT	331 @ 100MHz	45 @ 250MHz	600	1.40	310
PE-0805CD391GTT	PE-0805CD391JTT	386 @ 50MHz	35 @ 250MHz	560	1.50	290

(Continued on next page)

WIRE WOUND RF CHIP INDUCTORS

0805CD SERIES

Electrical Specifications @ 25°C - Operating Temperature Range -40°C to +125°C (continued)

Part Number Tolerance +/-2%	Part Number Tolerance +/-5%	Inductance ¹ (nH)	Q ² (MIN)	SRF ³ (MHz MIN)	Rdc ⁴ (Ω MAX)	I _{dc} ⁵ (mA MAX)
PE-0805CD471GTT	PE-0805CD471JTT	477 @ 25MHz	33 @ 100MHz	375	1.76	250
PE-0805CD561GTT	PE-0805CD561JTT	545 @ 25MHz	23 @ 50MHz	340	1.90	230
PE-0805CD681GTT	PE-0805CD681JTT	674 @ 25MHz	23 @ 50MHz	188	2.20	190
PE-0805CD821GTT	PE-0805CD821JTT	783 @ 25MHz	23 @ 50MHz	215	2.35	180
PE-0805CD102GTT	PE-0805CD102JTT	1000 @ 25MHz	20 @ 50MHz	200	3.60	150
PE-0805CD122GTT	PE-0805CD122JTT	1200 @ 25MHz	20 @ 50MHz	200	4.10	120
N/A	PE-0805CD152JTT	1500 @ 25MHz	20 @ 50MHz	200	5.00	100

Notes:

- Inductance measured using a HP4286A RF Impedance Analyzer. (Please note that inductance information is not stamped on part, because of the extremely small size).
- Q measured using a HP4291A RF Impedance Analyzer with a HP16193A Test Fixture.
- SRF measured using a HP8753C Network Analyzer.
- RDC measured using a Valhalla Scientific model 4100 ATC Digital Ohmmer.
- Based on a 15°C maximum temperature rise.
- Check ordered tolerance band carefully:
To order a +/-2% tolerance band the ordering code ends with "GTT" while any +/-5% tolerance band ends with "JTT".

Typical Q vs Frequency

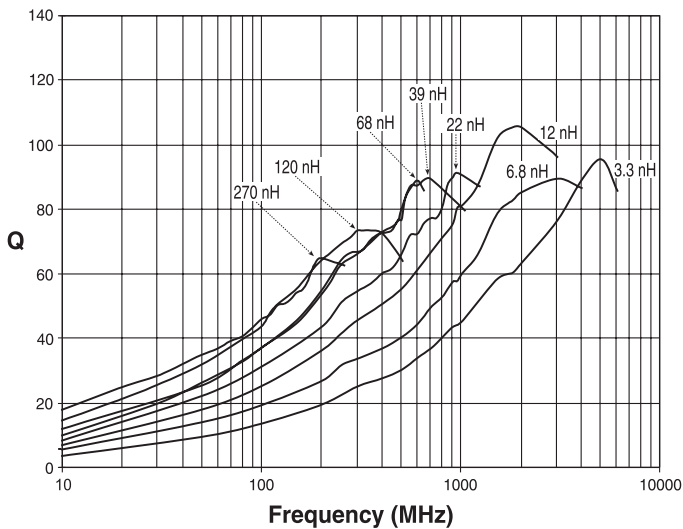

Typical Inductance vs Frequency

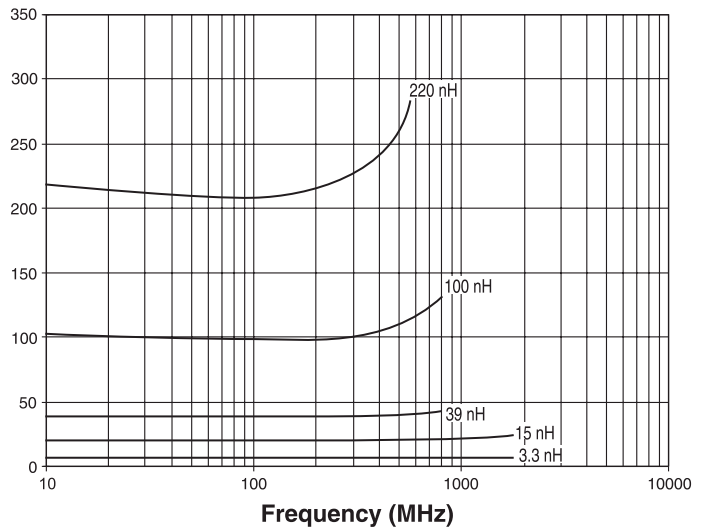

Mechanical

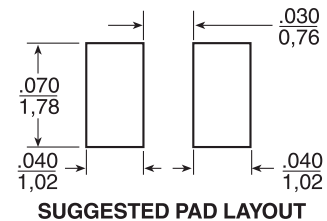
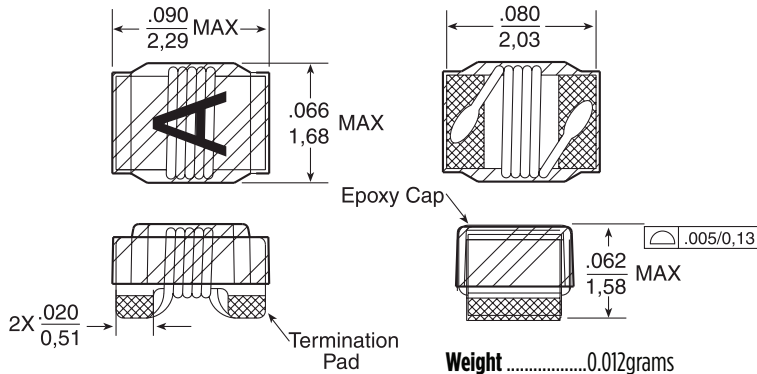

Dimensions: Inches / mm

Unless otherwise specified, all tolerances are ± .010 / 0,25

WIREWOUND RF CHIP INDUCTORS

0805FT SERIES

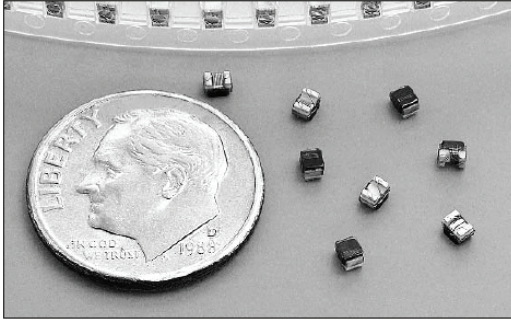

- Wire wound ferrite core construction
- High Q values
- High self resonant frequency
- Temperature Range -40°C to +125°C
- Industry standard 0805 (2012) size and surface mount land pattern
- 100% Tin Solder Termination

Electrical Specifications @ 25°C - Operating Temperature Range -40°C to +125°C

Part Number Tolerance +/-5%	Inductance ¹ (μ H)	Q ² (MIN)	SRF ³ (MHz MIN)	Rdc ⁴ (Ω MAX)	I _{dc} ⁵ (mA MAX)
PE-0805FT102JTT	1.0 @ 7.96MHz	15 @ 7.96MHz	63	1.20	245
PE-0805FT152JTT	1.5 @ 7.96MHz	15 @ 7.96MHz	60	1.45	225
PE-0805FT222JTT	2.2 @ 7.96MHz	15 @ 7.96MHz	58	1.80	200
PE-0805FT332JTT	3.3 @ 7.96MHz	15 @ 7.96MHz	50	2.30	175
PE-0805FT472JTT	4.7 @ 7.96MHz	15 @ 7.96MHz	43	2.80	140
PE-0805FT682JTT	6.8 @ 7.96MHz	15 @ 7.96MHz	36	3.40	115
PE-0805FT103JTT	10 @ 2.52MHz	10 @ 2.52MHz	30	4.70	98
PE-0805FT153JTT	15 @ 2.52MHz	10 @ 2.52MHz	23	6.50	80
PE-0805FT223JTT	22 @ 2.52MHz	10 @ 2.52MHz	20	8.00	68
PE-0805FT333JTT	33 @ 2.52MHz	10 @ 2.52MHz	17	10.70	60
PE-0805FT473JTT	47 @ 2.52MHz	10 @ 2.52MHz	14	13.80	55
PE-0805FT683JTT	68 @ 2.52MHz	8 @ 2.52MHz	11	17.50	49

- Notes:**
- Inductance measured using a HP4286A RF Impedance Analyzer. (Please note that inductance information is not stamped on part, because of the extremely small size).
 - Q measured using a HP4291A RF Impedance Analyzer with a HP16193A Test Fixture.
 - SRF measured using a HP8753C Network Analyzer.
 - RDC measured using a Valhalla Scientific model 4100 ATC Digital Ohmmer.
 - Based on a 15°C maximum temperature rise.

Mechanical

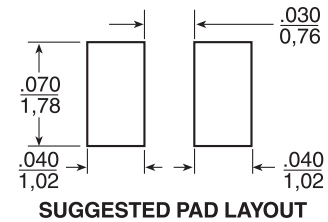
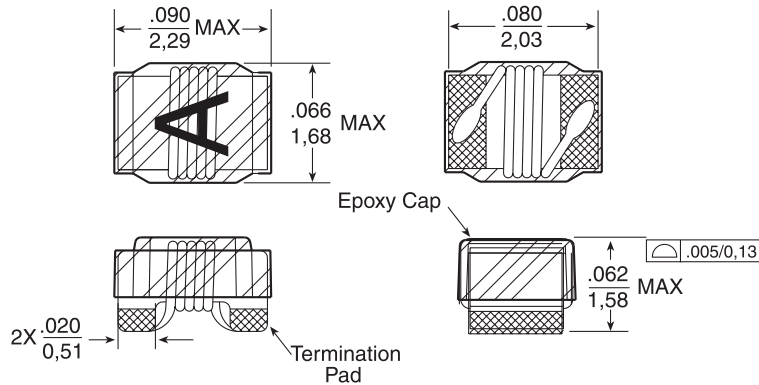

Dimensions: Inches / mm

Unless otherwise specified, all tolerances are $\pm \frac{.010}{0,25}$

Weight0.012grams

WIREWOUND RF CHIP INDUCTORS 0805FT SERIES

Typical Q vs Frequency

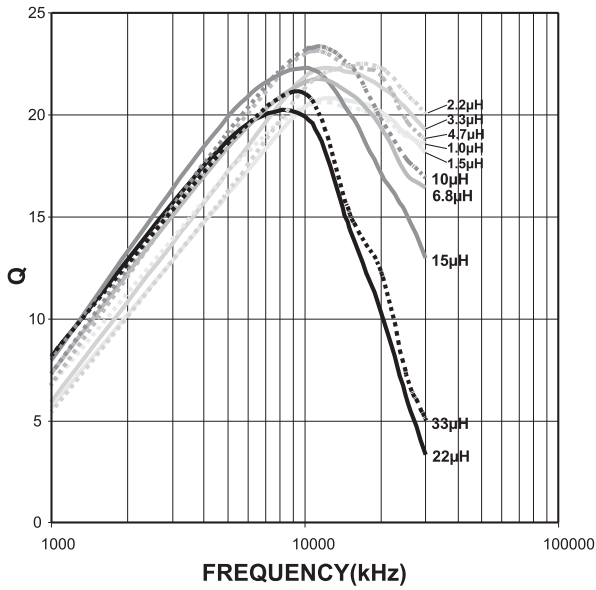

Typical Inductance vs Frequency

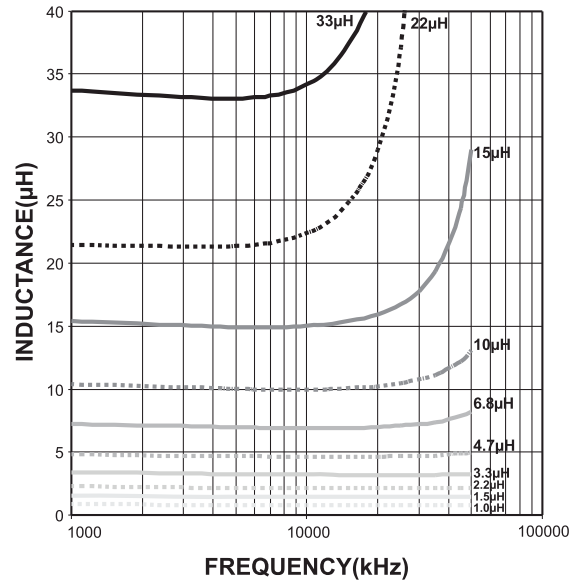

Tape and Reel Specifications

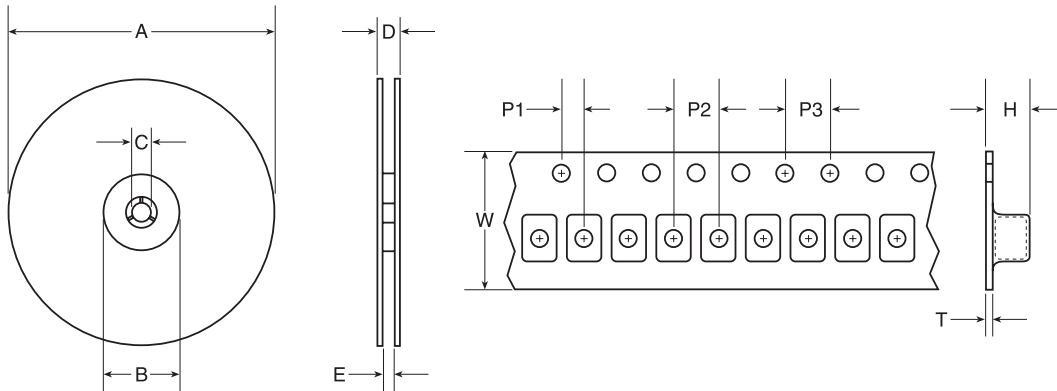

Packing Moisture Level = MSL 1 - Storage Temperature - 40°C to +125°C

Series	Parts per Reel	Reels Dimensions (mm)					Tape Dimensions (mm)					
		A	B	C	D	E	W	P1	P2	P3	H	T
0805CD	2000	178	50	13	14.4	8.4	8	2	4	4	2.1	0.3
0805FT												

Notes: P1, P2 and P3 are same for all chip inductor series. Keeping the same dimensions for guide hole and pocket pitch (P1), pocket pitch (P2), guide hold pitch (P3) and tape width (8mm) for all series, enables the packaging machine to maintain the same settings while changing models. The only difference between the series are the parts per reel which contributes to a different length of tapes/reel per model.

WIRE WOUND RF CHIP INDUCTORS

PERFORMANCE TESTING

Electrical Testing

Storage and Operating Temperature Range: -40°C to +125°C	Inductors are subjected to the extremes for 48 hours. Then tested at 25°C	There shall be no deformation or change in appearance Inductance shall not change by more than 35% Q values shall not change by more than 310%
Thermal: -40°C to +85°C	Inductors are subjected to 30 cycles for 30 minutes at each extreme. Then tested at 25°C	
Moisture Resistance 240 Hours at 70°C	Inductors are subjected to 10 cycles of 24 hours at 90 to 95% relative humidity Then tested at 24°C	
Operating Life	Inductors are subjected to 1000 hours at 85°C with 85% Relative Humidity with the rated current applied	

Mechanical Testing

Temperature Range:	Inductors are subjected to the following: Use a solder pot at 260°C, with RMA Flux. Each termination is immersed in 63Sn/37Pb molten solder for 4 to 6 seconds.	There shall be no deformation or change in appearance Inductance shall not change by more than 35% Q values shall not change by more than 310%
Recommended Solder Heat Resistance Profile		

Physical Specifications

Vibration (Random)	Samplers are subjected to random vibrations as per NAVMAT P9492	There shall be no deformation or change in appearance Inductance shall not change by more than 35% Q values shall not change by more than 310%
Mechanical Shock	Inductors are subjected to one half sine wave pulse (8700 g's for 0.3ms) in each directional axis for a total of 18 shocks	
Moisture Resistance	Reflow Inductors on to test pads using 63Sn/37Pb solder paste (IR Reflow profile = 200°C for 30 seconds or peak 235°C for 20 seconds)	The inductors shall withstand a minimum force of 1000 g's in any direction using a dynamometer force guage