

TYPE RP17 PUSH-PULL LOCK CONNECTORS

Scope

RP17 series connectors are designed for interfacing 8 mm video equipment and office automation equipment with miniature, lightweight, high durability 12 pin circular connectors.

RP17 series connectors are ideal for quick connection and disconnection by push-pull lock connection. The slim body will fit a variety of electrical equipment.

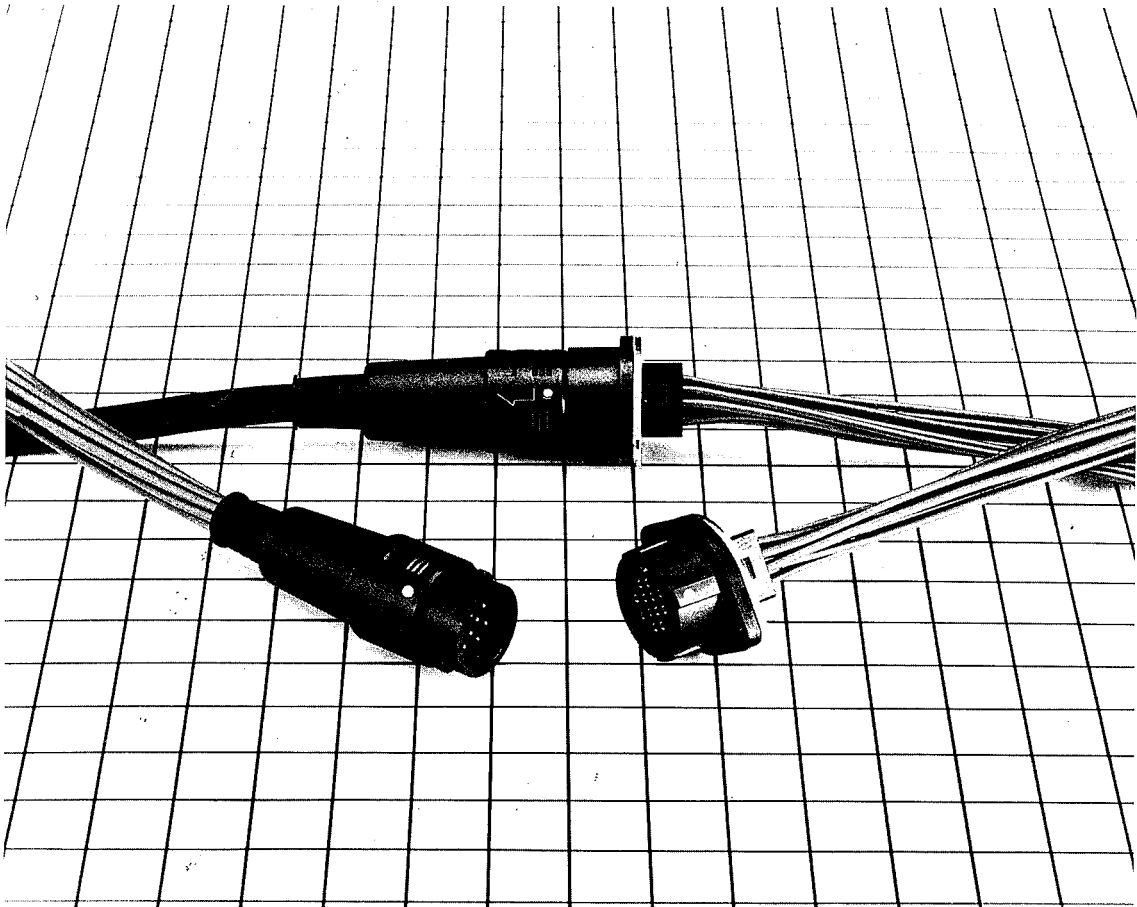

Features

- (1) One touch "push-pull lock" coupling mechanism assures easy and quick connecting and disconnecting, also assure high density mounting.
- (2) Use applicable cable AWG#18~#22 (shielded outer dia. 1.7 under) to 3 pins among 12 pins and other applicable cable AWG#24~#30 (shielded outer dia. 1.2 under) to be usable due to crimp terminal.
- (3) Mating guide keys is multiple polarizing to be ensured specified position.
- (4) Simple and slender appearance with internal installed cable clamp. External appearance is matte finish black color.
- (5) Mating position mark is located with white color, assures easy and quick connection and disconnection.

Application

8 mm video equipment, Portable radio communications equipment, Remote Control equipment, Sound facilities and small electric devices.

Material and Finish

Description	Material	Finish
Shell and Insulator	Glass-filled Polycarbonate (UL94V-0) or PBT resin	Black
Male Pin	Phosphor bronze	Silver plating
Female Pin	Phosphor bronze	Silver plating

Ordering Information

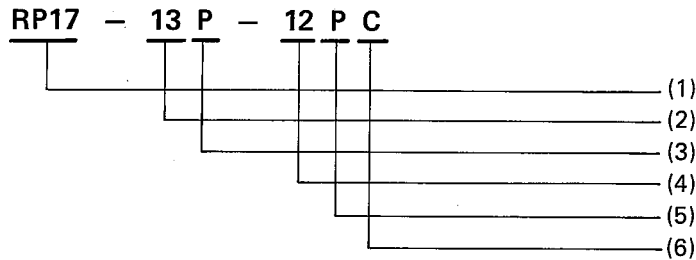

- | | |
|--|--|
| (1) RP17: Name of series | (4) 12: Number of pins
12 pole only is available for this connector. |
| (2) 13: Size of shell, or outer dia. of mating section.
Size 13 is only available for this connector. | (5) P: Type of pin
P: Male pin
S: Female pin |
| (3) P: Type of connector
P: Plug
R: Receptacle
J: Jack | (6) C: Type of connection method or type of terminal are classified in alphabet. |

Plug

Plug

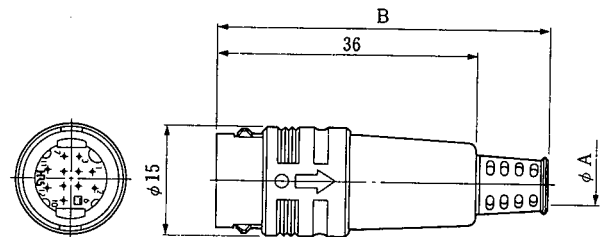
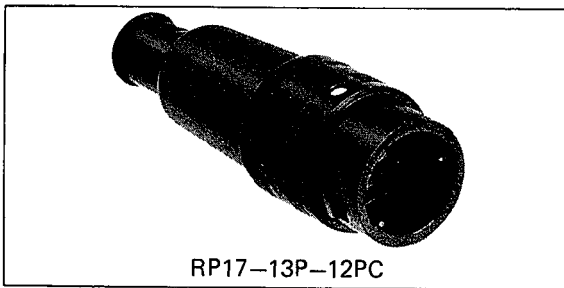

(An example in shape)

HRS No.	Part No.	ϕA	B	Remarks
113-0501-0	RP17-13P-12PC	5.3	46	
113-0512-7	RP17-13PA-12PC	6.1	51	

(Electrostatic Protection Type)

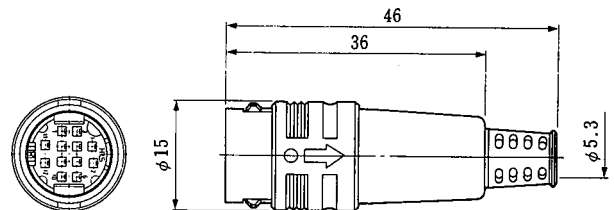
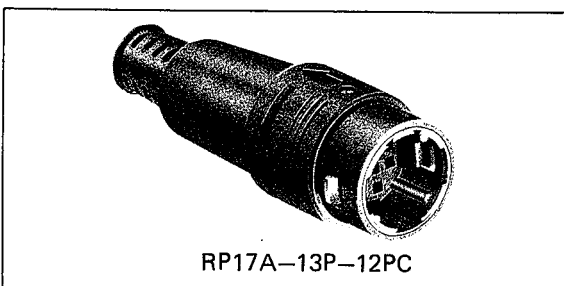

(An example in shape)

HRS No.	Part No.	Remarks
113-0551-9	RP17A-13P-12PC	

Receptacle

(Crimp Type)

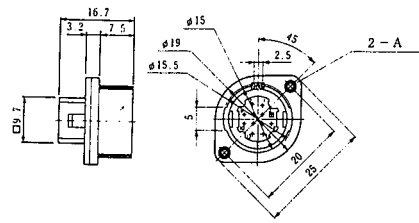
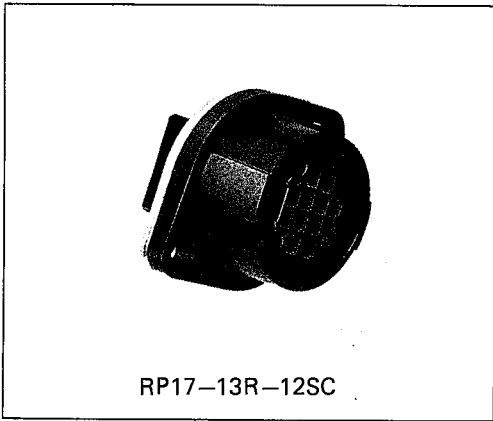

(An example in shape)

HRS No.	Part No.	A	Remarks
113-0502-3	RP17-13R-12SC	M2.6x0.45	

(Dip Type)

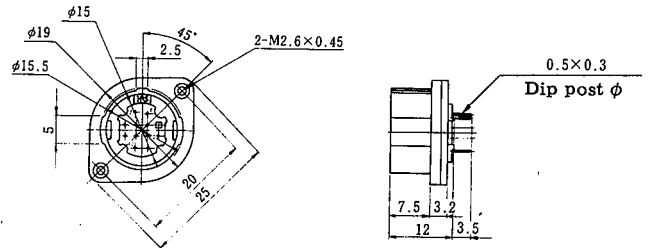
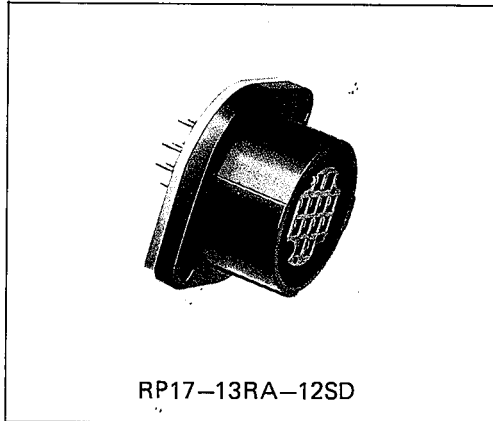

(An example in shape)

HRS No.	Part No.	Remarks
113-0511-4	RP17-13RA-12SD	

Remark: PCB layout is shown page 138.

Receptacle(Electrostatic Protection Type)

(Dip Type)

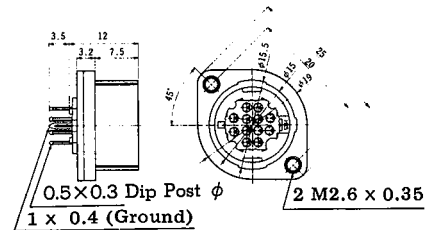

(An example in shape)

HRS No.	Part No.	Remarks
113-0553-4	RP17A-13RA-12SD	

Remark: PCB layout is shown page 138.

Jack

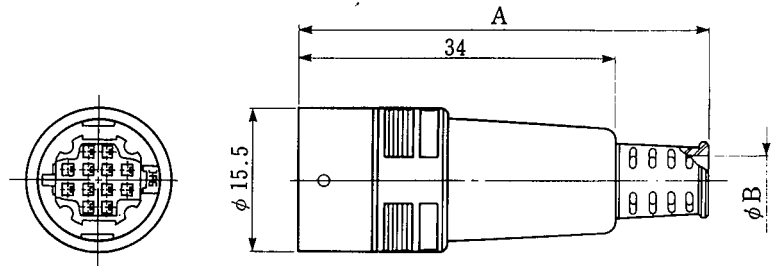
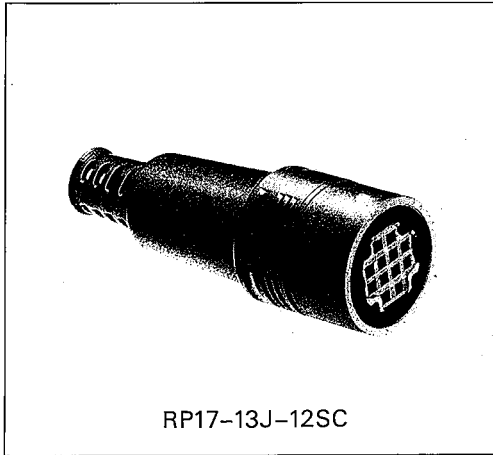

(An example in shape)

HRS No.	Part No.	A	φB	Note
113-0515-5	RP17-13J-12SC	44	5.3	
113-0516-8	RP17-13JA-12SC	49		

PCB Layout

● General Part

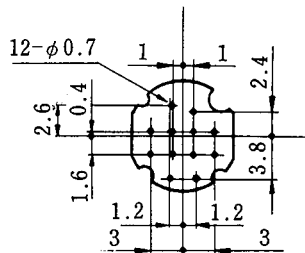

● Electrostatic Protected Part

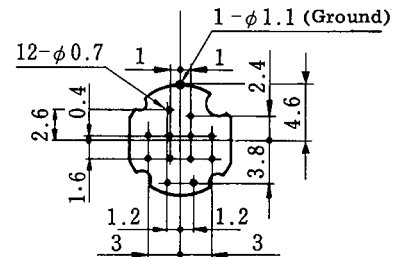

Note: The contact arrangement shows from the mating side of receptacle.

Contact

Male Pin

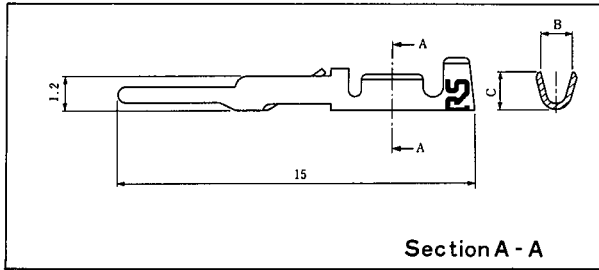

Type	HRS No.	Part No.	B	C	Applicable Wire
Loose	113-0503-6	RP17-PC-112	1.6	2.1	AWG#18~#22
	113-0504-9	RP17-PC-122	1.2	1.35	AWG#24~#30
Chain	113-0507-7	RP17-PC-212	1.6	2.1	AWG#18~#22
	113-0508-0	RP17-PC-222	1.2	1.35	AWG#24~#30

Female Pin

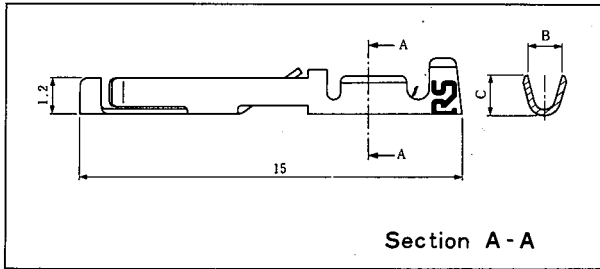

Type	HRS No.	Part No.	B	C	Applicable Wire
Loose	113-0505-1	RP17-SC-112	1.6	2.1	AWG#18~#22
	113-0506-4	RP17-SC-122	1.2	1.35	AWG#24~#30
Chain	113-0509-2	RP17-SC-212	1.6	2.1	AWG#18~#22
	113-0510-1	RP17-SC-222	1.2	1.35	AWG#24~#30

Note: Loose piece terminals are offered in a package containing 100 pieces and terminal by reel containing 10,000 pieces.

Applicable tools

Type	Item	HRS No.	Part No.	Applicable terminal	Applicable wire
Manual	Manual crimping tool	150-0043-8	RP17-TC-11	RP17- ^{PC} / _{SC} -112	AWG#18~#22
		150-0044-0	RP17-TC-12	RP17- ^{PC} / _{SC} -122	AWG#24~#30
Automatic	Automatic crimping body	901-0005-4	CM-105	—	—
	Applicator	901-2036-9	AP105-RP17-1	RP17- ^{PC} / _{SC} -212	AWG#18~#22
		901-2026-5	AP105-RP17-2	RP17- ^{PC} / _{SC} -222	AWG#24~#30
	Cable crimping tool	150-0042-5	RP17-TC-01	—	—
	Extractor	150-0039-0	RP6-SC-TP	—	—

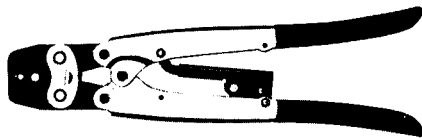

Hand Clamping Tool



Extraction Tool



Hand Crimp Tool

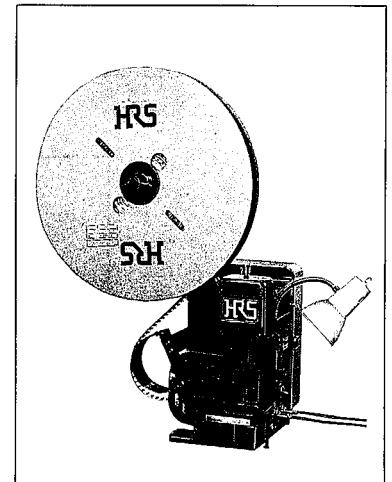

Auto Crimp Tool
CM-105

Assembling Procedure

Plug

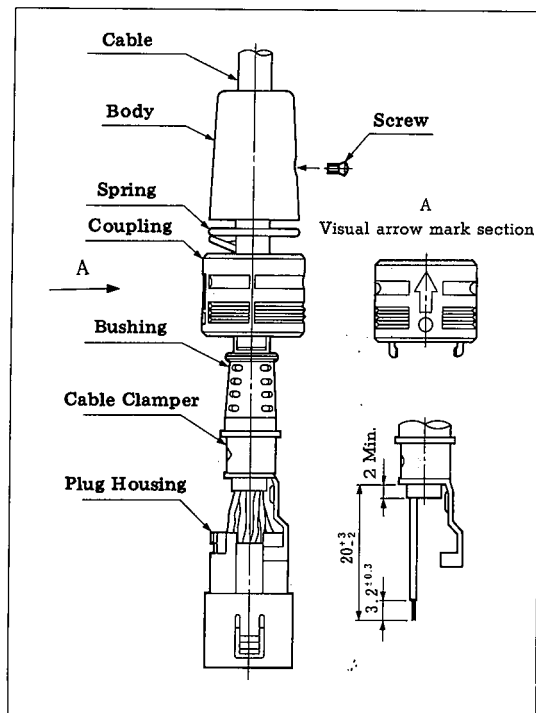

1. Fit the body, spring, coupling and bushing respectively in advance on wires having ends suitably treated, and then connect wires to terminals by crimp.
2. Then mount crimped contacts into the plug housing. After mounting, pull the wire slightly and make sure if the contact is mounted.
3. Fix a cable clamper to the bushing, insert it into the plug housing, and then crimp cable clamper with tool RP17-TC-01.
4. Assemble coupling, spring and body respectively to plug housing, and mount it with the attached screw by means of torque wrench (2 kg-cm), and the work is completed.
5. Put the cable bushing over the clamp body to complete the job.

Contact Arrangement

Contact Arrangement		
No. of Pin	12	
Withstanding Voltage	AC 1000V for 1 minute	
Current Capacity	5A (AWG #18 ~ #22)	2A (AWG #24 ~ #30)
	Fit contact No. 2, 11, 12	1, 3, 4, 5, 6, 7, 8, 9, 10
Insulation Resistance	1000 MΩ min at DC500V	
Contact Resistance	15 mΩ max at DC1A	
Applicable Wire	AWG #18 ~ #22 (Large barrel) AWG #24 ~ #30 (Small barrel)	

Remarks:

1. The figure indicates a view from the fitting face side (Plug's wire connecting) of the receptacle and jack.
2. The withstanding voltage is indicated by the test voltage value.