

Pin No.	DIM A
TF-123-ARP9H17	1.70
TF-123-ARP9H15	1.50

Specification:

- ELECTRICAL CHARACTERISTICS
  - CONTACT RESISTANCE: 80 milliohms MAX.
  - INSULATION RESISTANCE: 1,000 Megohms MIN.
  - DIELECTRIC WITHSTANDING VOLTAGE: 500V AC FOR 1 MINUTE.
- MECHANICAL CHARACTERISTICS
  - DURABILITY: 5,000 CYCLES
- RoHS 2002/95/EC COMPLIANT.

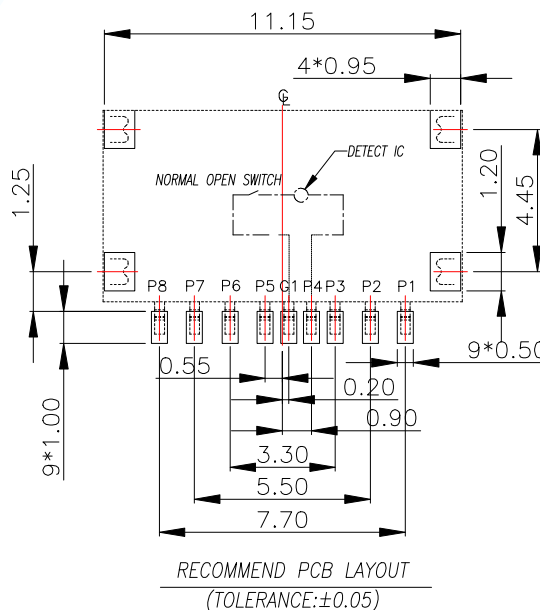
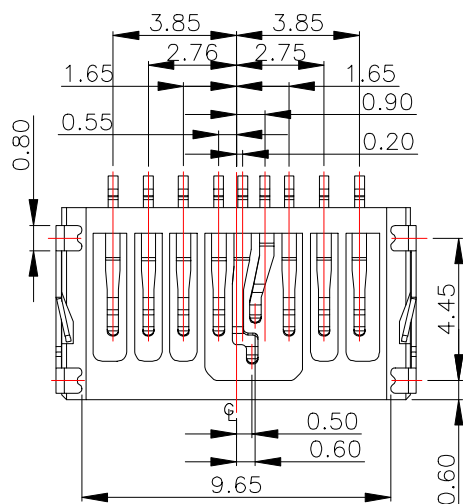
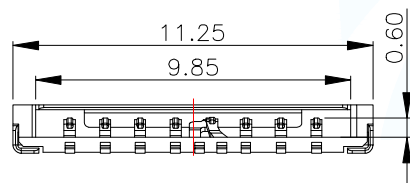
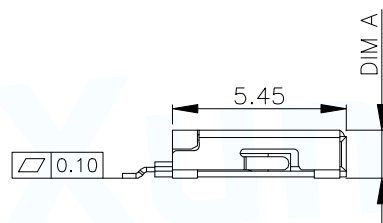

Pin No.	Pin assignment
PIN1	DAT2
PIN2	CD/DAT3
PIN3	CMD
PIN4	VDD
G1	SWITCH
PIN5	CLK
PIN6	VSS
PIN7	DAT0
PIN8	DAT1

C	SHELL	1	STAINLESS STEEL 0.15t	Ni PLATING
B	CONTACT	9	COPPER ALLOY 0.15t	Gold Flash On Contact Area Tin plated on Solder tail All over Nickel Plated .
A	HOUSING	1	HIGH-TEMPERATURE PLASTIC UL94-V0	BLACK
NO	DESCRIPTION	QTY	MATERIAL	PLATING & COLOR

MANUFACTURE DWG



UNLESS OTHERWISE SPECIFIED TOLERANCES



TITLE: T-FLASH CONN 9P SIMPLE SOCKET (With Detect)

DECIMALS:	ANGLES:
X.: ±0.50	X'.: ±2°
X.X: ±0.30	X.X': ±1°
X.XX: ±0.20	

PAR	TF-123-ARP9HXX
DWN	
CHKD	
APVD	
SCALE: 1:1	UNIT: MM
SIZE: A4	SHEET: 1F1
CUSTOMER COPY	REV: A

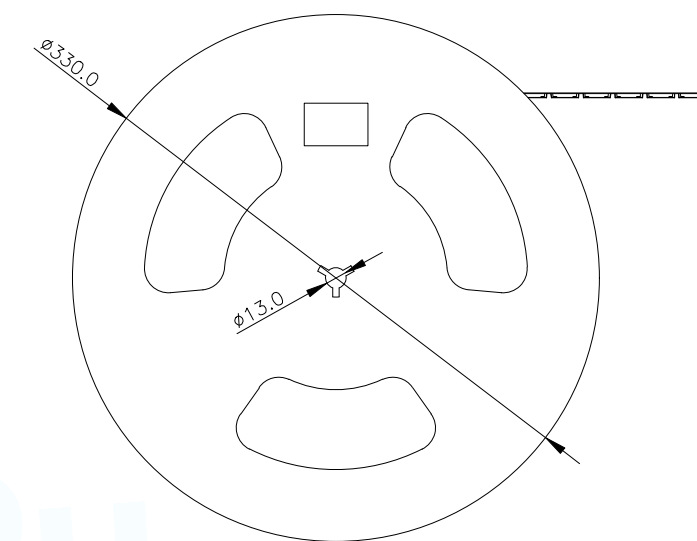
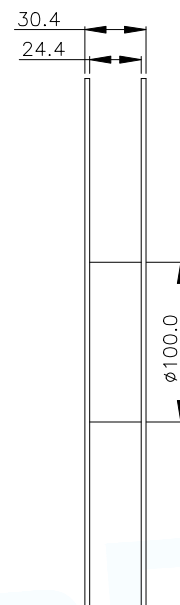
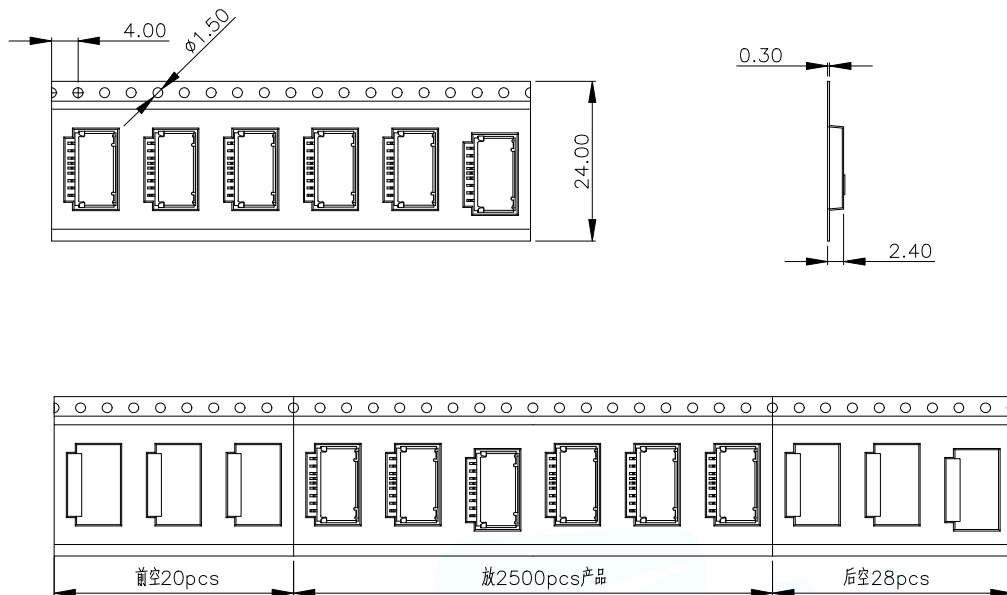

NO.1

NO.2

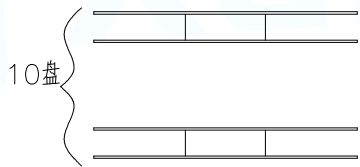
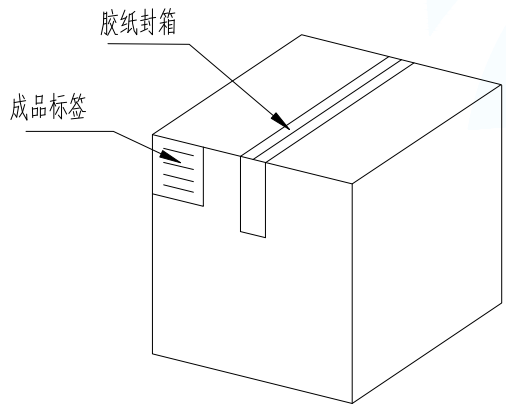

1. 材质要求:
- 1.1 纸箱的材质为A=B;外形尺寸为34\*34\*30;
  - 1.2 卷盘的材质为PVC,卷盘的外形尺寸为 $\phi 330*30.4$ ;
  - 1.3 卷带的材质为PVC,卷带的外形尺寸为24400\*24.00\*2.4mm;
2. 包装方式:
- 2.1 将卷带放入包装机后,前空20PCS,后放产品2500PCS,再后空28PCS.
  - 2.2 将包装好的产品从包装机上取下并包装好;
  - 2.3 把累叠好的11盘叠放入纸箱中共计27.5Kset;
  - 2.4 把包装好的成品打包封箱,并在纸箱外贴上标签

纸箱规格:340\*340\*300

NO.4

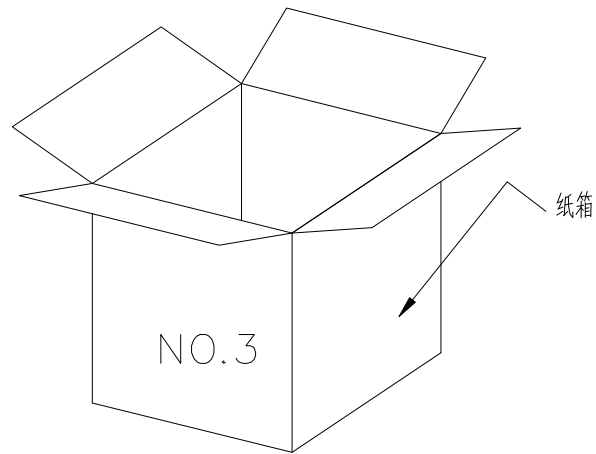

MANUFACTURE DWG			东莞市讯普电子科技有限公司 DongGuan XunPu Electronics Co.,Ltd	
UNLESS OTHERWISE SPECIFIED TOLERANCES			TITLE:T-FLASH CONN 9P SIMPLE SOCKET (With Detect)	
DECIMALS:	ANGLES:	PAR	TF-123-ARP9HXX	
X.: $\pm 0.50$	X'.: $\pm 2'$	DWN		
X.X: $\pm 0.30$	X.X': $\pm 1'$	CHKD		
X.XX: $\pm 0.20$		APVD		
CUSTOMER COPY		SCALE1:1	UNIT:MM	
		SIZE:A4	SHEET:1F1	REV:A