

NEMA line Outlet 5-15R, Snap-in Mounting, Front Side, V-Slot Terminal



NEMA 5-15R



See below:

[Approvals and Compliances](#)

Description

- Panel mount :
 Snap-in , Front Side
- 1 Function :
 Line Outlet , Protection class I
- V-Slot- Connector

Characteristics

- Designed for standard applications

References

Last order date: 15.12.2021

Weblinks

[pdf data sheet](#), [html datasheet](#), [General Product Information](#), [Approvals](#), [Distributor-Stock-Check](#), [Accessories](#), [Detailed request for product](#)

Technical Data

Ratings UL/CSA	15A / 125VAC; 60Hz
Allowable Operation Temperature	-25 °C to +60 °C
IP-Protection	front side IP20 acc. to IEC 60529
Protection against electric shock	Suitable for appliances with protection class I acc. to IEC 61140
Terminal	V-Slot- Connector
Panel Thickness S	Snap-in 0.8mm to 1.6mm
Material: Housing	Thermoplastic, black

Approvals and Compliances

Detailed information on product approvals, code requirements, usage instructions and detailed test conditions can be looked up in [Details about Approvals](#)

SCHURTER products are designed for use in industrial environments. They have approvals from independent testing bodies according to national and international standards. Products with specific characteristics and requirements such as required in the automotive sector according to IATF 16949, medical technology according to ISO 13485 or in the aerospace industry can be offered exclusively with customer-specific, individual agreements by SCHURTER.

Approvals





The approval mark is used by the testing authorities to certify compliance with the safety requirements placed on electronic products.

Approval Reference Type: 0709-1

Approval Logo	Certificates	Certification Body	Description
	UL Approvals	UL	UL File Number: E103791
	CSA Approvals	CSA	CSA Certification Record: 73165

Product standards

Product standards that are referenced

Organization	Design	Standard	Description
	Designed according to	IEC 60320-1	Appliance couplers for household and similar general purposes
	Designed according to	IEC 60320-1	Appliance couplers for household and similar general purposes
	Designed according to	UL 498	Standard for Attachment Plugs and Receptacles
	Designed according to	CSA C22.2 no. 42	General Use Receptacles, Attachment Plugs, and Similar Wiring Devices



Application standards

Application standards where the product can be used

Organization	Design	Standard	Description
	Designed for applications acc.	IEC/UL 62368-1	Audio/video, information and communication technology equipment - Part 1: Safety requirements

Compliances

The product complies with following Guide Lines

Identification	Details	Initiator	Description
	CE declaration of conformity	SCHURTER AG	The CE marking declares that the product complies with the applicable requirements laid down in the harmonisation of Community legislation on its affixing in accordance with EU Regulation 765/2008.
	China RoHS	SCHURTER AG	The law SJ / T 11363-2006 (China RoHS) has been in force since 1 March 2007. It is similar to the EU directive RoHS.
	REACH	SCHURTER AG	On 1 June 2007, Regulation (EC) No 1907/2006 on the Registration, Evaluation, Authorization and Restriction of Chemicals 1 (abbreviated as "REACH") entered into force.

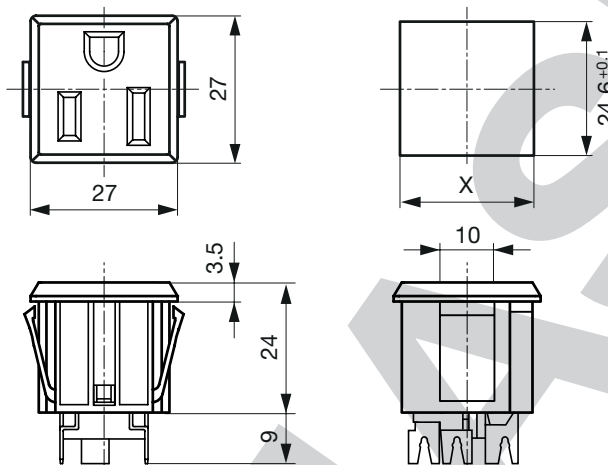
Dimensions [mm]

Panel thickness X
 0.8 - 1.2 mm: 24.6 mm
 1.3 - 1.6 mm: 24.8 mm

Assembly Instructions



Installation Diagram: V-slotted terminals for connecting multiple receptacles (only for solid bare wires from type 14 AWG)

All Variants

Type	Protection Class	Panel mounting	Panel Thickness s [mm]	Terminal	Color	Order Number
0709-1	I	Snap-in	0.8 -1.6	V-Slot- Connector	black	4300.0702

Availability for all products can be searched real-time: <https://www.schurter.com/en/Stock-Check/Stock-Check-SCHURTER>

Packaging unit

120 Pcs

Mating Inlets/Plugs

Category / Description

[Power Supply Cord Overview complete](#)



Cord Sets 16 A, Europlug, 2.5 m, Connector IEC C19, H05VV-F3G1.5, black	6004.0395
Cord Sets 16 A, Interconnection, 1.0 m, Connector IEC C19, H05VV-F3G1.5, black	6020.0392
Cord Sets 16 A, Interconnection, 2.0 m, Connector IEC C19, H05VV-F3G1.5, black	6020.0394
Cord Sets 16 A, North America, 2.5 m, Connector IEC C19, SJT 3x14 AWG, black	6009.5195
Cord Sets 10 A, North America, 2.5 m, Connector IEC C13, SJT 3x18 AWG, black	6009.1315

...