

SURFACE MOUNT SCHOTTKY BARRIER DIODE ARRAYS

Features

- Low Forward Voltage Drop
- Fast Switching
- Ultra-Small Surface Mount Package
- PN Junction Guard Ring for Transient and ESD Protection
- **Lead Free/RoHS Compliant (Note 3)**

Mechanical Data

- Case: SOT-363
- Case Material: Molded Plastic. UL Flammability Classification Rating 94V-0
- Moisture Sensitivity: Level 1 per J-STD-020C
- Terminals: Solderable per MIL-STD-202, Method 208
- Lead Free Plating (Matte Tin Finish annealed over Alloy 42 leadframe).
- Orientation: See Diagrams Below
- Marking: See Diagrams Below & Page 3
- Weight: 0.006 grams (approximate)

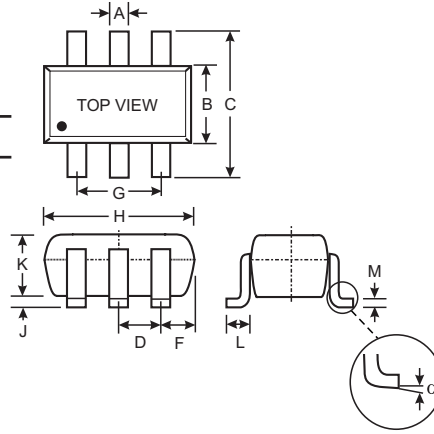

SOT-363		
Dim	Min	Max
A	0.10	0.30
B	1.15	1.35
C	2.00	2.20
D	0.65 Nominal	
F	0.30	0.40
H	1.80	2.20
J	—	0.10
K	0.90	1.00
L	0.25	0.40
M	0.10	0.25
α	0°	8°
All Dimensions in mm		

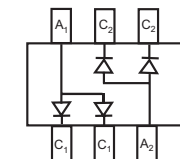

BAS70DW-06*
Marking: K76

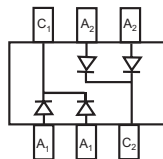

BAS70DW-05*
Marking: K71

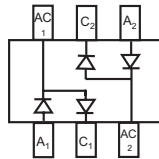

BAS70DW-04*
Marking: K74

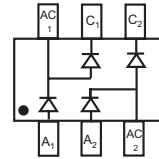

BAS70BRW
Marking: K75

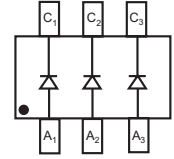

BAS70TW
Marking: K73

*Symmetrical configuration, no orientation indicator.

Maximum Ratings @ $T_A = 25^\circ\text{C}$ unless otherwise specified

Characteristic	Symbol	Value	Unit
Peak Repetitive Reverse Voltage Working Peak Reverse Voltage DC Blocking Voltage	V_{RRM} V_{RWM} V_R	70	V
RMS Reverse Voltage	$V_{R(RMS)}$	49	V
Forward Continuous Current (Note 1)	I_{FM}	70	mA
Non-Repetitive Peak Forward Surge Current @ $t < 1.0\text{s}$	I_{FSM}	100	mA
Power Dissipation (Note 1)	P_d	200	mW
Thermal Resistance Junction to Ambient Air (Note 1)	$R_{\theta JA}$	625	$^\circ\text{C}/\text{W}$
Operating and Storage Temperature Range	T_j T_{STG}	-55 to +125 -65 to +125	$^\circ\text{C}$

Electrical Characteristics @ $T_A = 25^\circ\text{C}$ unless otherwise specified

Characteristic	Symbol	Min	Max	Unit	Test Condition
Reverse Breakdown Voltage (Note 2)	$V_{(BR)R}$	70	—	V	$I_R = 10\mu\text{A}$
Forward Voltage	V_F	—	410 1000	mV mV	$t_p < 300\mu\text{s}$, $I_F = 1.0\text{mA}$ $t_p < 300\mu\text{s}$, $I_F = 15\text{mA}$
Reverse Current (Note 2)	I_R	—	100	nA	$t_p < 300\mu\text{s}$, $V_R = 50\text{V}$
Total Capacitance	C_T	—	2.0	pF	$V_R = 0\text{V}$, $f = 1.0\text{MHz}$
Reverse Recovery Time	t_{rr}	—	5.0	ns	$I_F = I_R = 10\text{mA}$ to $I_R = 1.0\text{mA}$, $I_{rr} = 0.1 \times I_R$, $R_L = 100\Omega$

- Notes: 1. Part mounted on FR-4 board with recommended pad layout, which can be found on our website at <http://www.diodes.com/datasheets/ap02001.pdf>.
2. Short duration test pulse used to minimize self-heating effect.
3. No purposefully added lead.

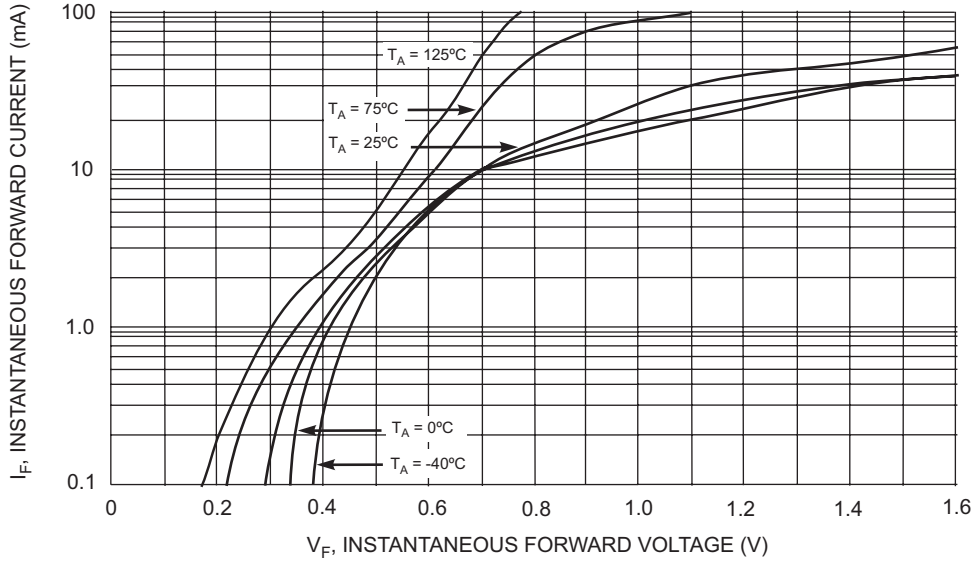

Fig. 1 Typical Forward Characteristics

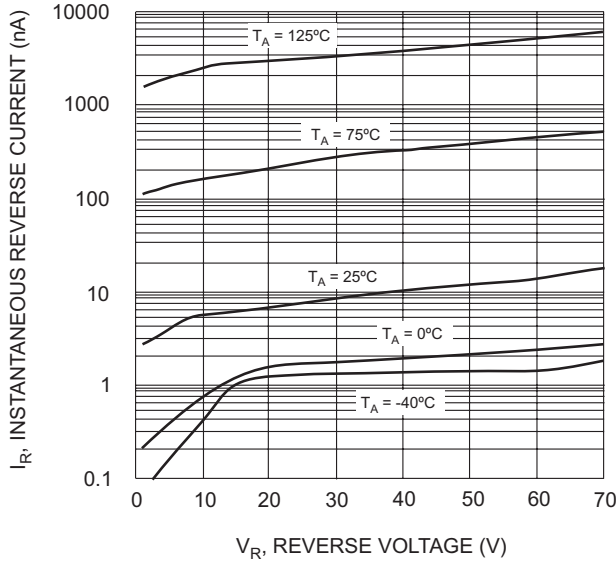

Fig. 2 Typical Reverse Characteristics

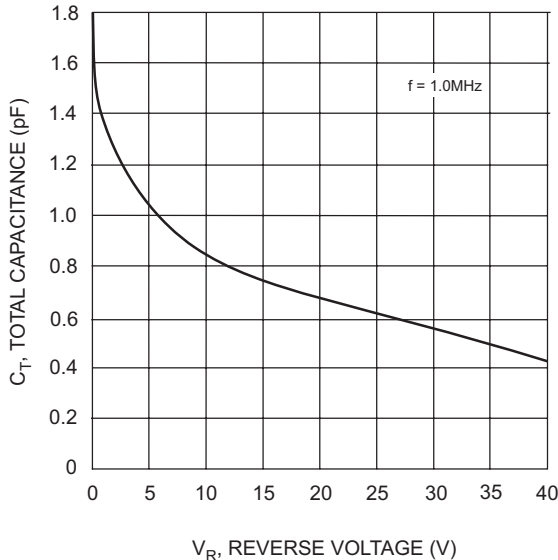

Fig. 3 Typical Capacitance

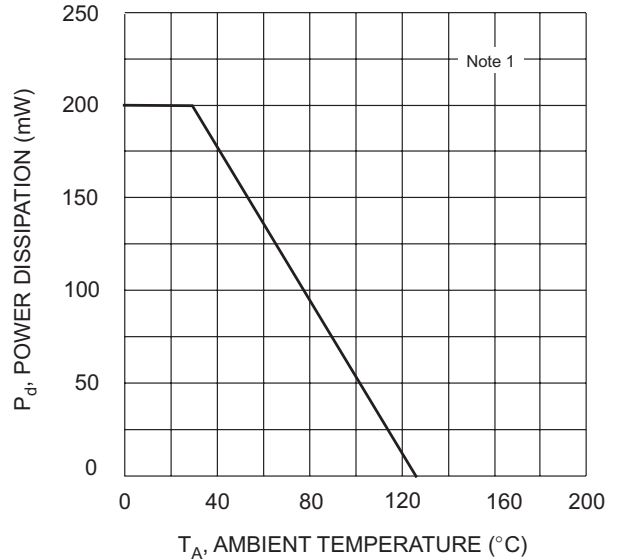

Fig. 4 Power Derating Curve, Total Package

Ordering Information (Note 4)

Device	Packaging	Shipping
BAS70DW-04-7-F	SOT-363	3000/Tape & Reel
BAS70DW-05-7-F	SOT-363	3000/Tape & Reel
BAS70DW-06-7-F	SOT-363	3000/Tape & Reel
BAS70BRW-7-F	SOT-363	3000/Tape & Reel
BAS70TW-7-F	SOT-363	3000/Tape & Reel

Notes: 4. For Packaging Details, go to our website at <http://www.diodes.com/datasheets/ap02007.pdf>.

Marking Information

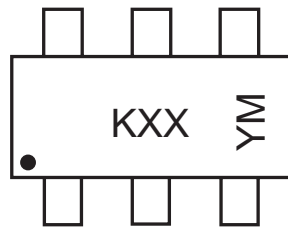

KXX = Product Type Marking Code (See Page 1)
 YM = Date Code Marking
 Y = Year ex: N = 2002
 M = Month ex: 9 = September

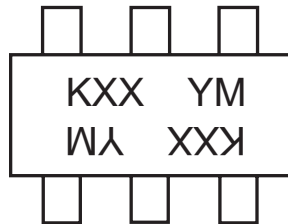

KXX = Product Type Marking Code (See Page 1)
 For Symmetrical Configuration, No Orientation Indicator
 YM = Date Code Marking
 Y = Year ex: N = 2002
 M = Month ex: 9 = September

Date Code Key

Year	2001	2002	2003	2004	2005	2006	2007	2008	2009	2010	2011	2012
Code	M	N	P	R	S	T	U	V	W	X	Y	Z

Month	Jan	Feb	March	Apr	May	Jun	Jul	Aug	Sep	Oct	Nov	Dec
Code	1	2	3	4	5	6	7	8	9	O	N	D

IMPORTANT NOTICE

Diodes Incorporated and its subsidiaries reserve the right to make modifications, enhancements, improvements, corrections or other changes without further notice to any product herein. Diodes Incorporated does not assume any liability arising out of the application or use of any product described herein; neither does it convey any license under its patent rights, nor the rights of others. The user of products in such applications shall assume all risks of such use and will agree to hold Diodes Incorporated and all the companies whose products are represented on our website, harmless against all damages.

LIFE SUPPORT

Diodes Incorporated products are not authorized for use as critical components in life support devices or systems without the expressed written approval of the President of Diodes Incorporated.