

Axial Auto Surge Suppressor

Stand-off Voltage - 24 to 48 Volts

18000 Watt Peak Pulse Power

Features

- Glass passivated junction
- Plastic package P-600
- Meet AEC-Q101 requirement
- Bi-directional or Un-directional
- Very Low Clamping Voltage
- High temperature soldering guaranteed: 265°C/10 seconds/.375", (9.5mm) lead length, 5lbs., (2.3kg) tension
- Continued current transient suppressor
- RoHScompliant
- 18KW peak pulse power capability on 10/1000us waveform



IEC Compatibility

- ISO 16750-2 Test A 24V System (174V 2Ω 350ms 10c)

Applications

- Auto powers system
- Can-bus
- ABS powers
- Car audio and video
- Automotive instrument
- Bluetooth
- Car GPS

I-V Curve Characteristics

Uni-directional

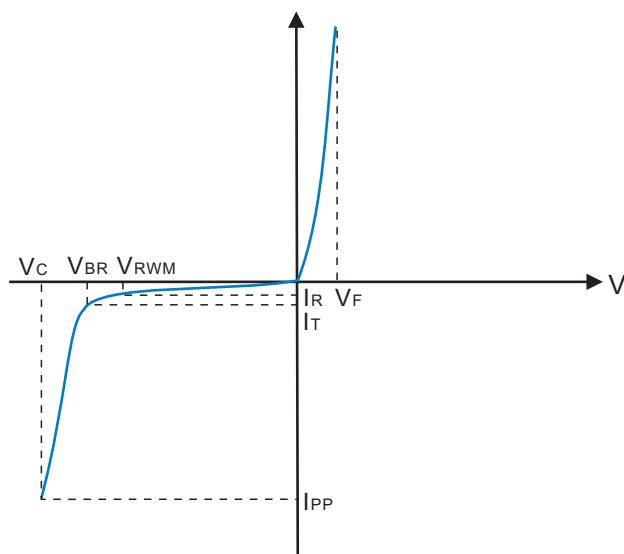

Bi-directional

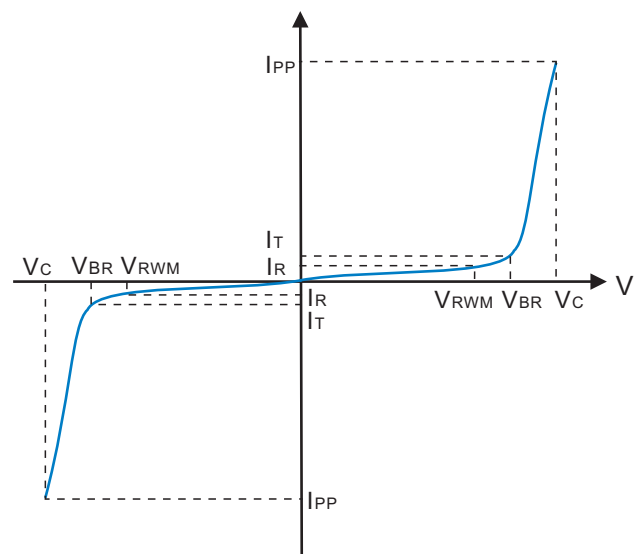

Dimensions (P600)

Case Style P600

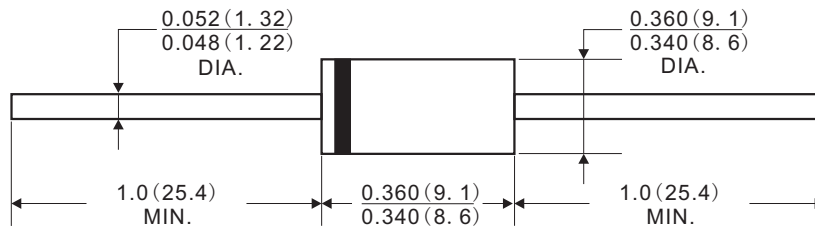

Dimensions in inches and (millimeters)

Electrical Characteristics

***Stand for commonly used models

PKT Part Number		Stand-Off Voltage	Reverse Leakage @V _{RWM}	Breakdown Voltage @I _T		Test Current	Max. Clamping Voltage @I _{pp} 10/1000μs	
UNI-Polar	BI-Polar	V _{RWM} (V)	I _R (μA)	V _{BR} (V)Min.	V _{BR} (V)Max.	I _T (mA)	V _c (V)	I _{pp} (A)
PKT24A	PKT24CA	24	10	26.7	29.5	5	38.9	462.7
* PKT30A	* PKT30CA	30	10	33.3	36.8	5	48.4	371.9
PKT33A	PKT33CA	33	2	36.7	40.6	5	53.3	337.7
* PKT36A	* PKT36CA	36	2	40.0	44.2	5	58.1	309.8
PKT48A	PKT48CA	48	2	53.6	58.7	5	77.7	231.7

Test ISO 16750-2 Test A

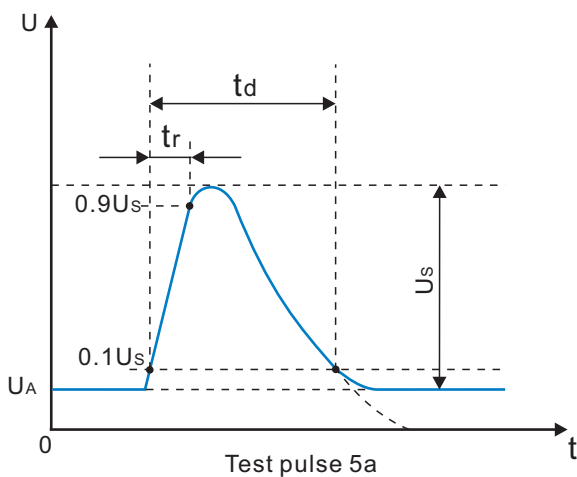

Parameter	12V System	24V System
U _s	79V to 101V	151V to 202V
R _i	0.5Ω to 4Ω	1Ω to 8Ω
t _d	40ms to 400ms	100ms to 350ms
t _r	(10^{0}_{-5}) ms	

Ratings and Characteristic Curves (TA=25 °C unless otherwise noted)

Fig.1 Peak Pulse Power Rating Curve

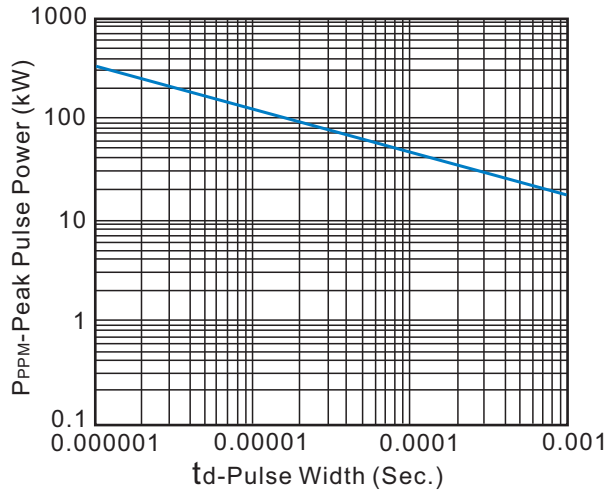

Fig.2 Typical Junction Capacitance

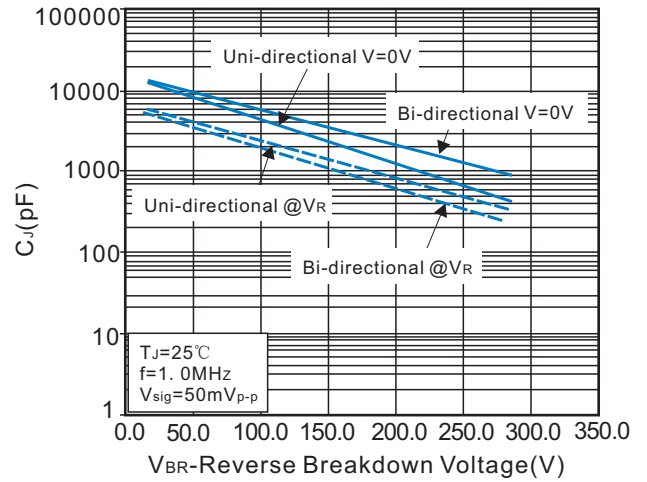

Fig.3 Pulse Waveform

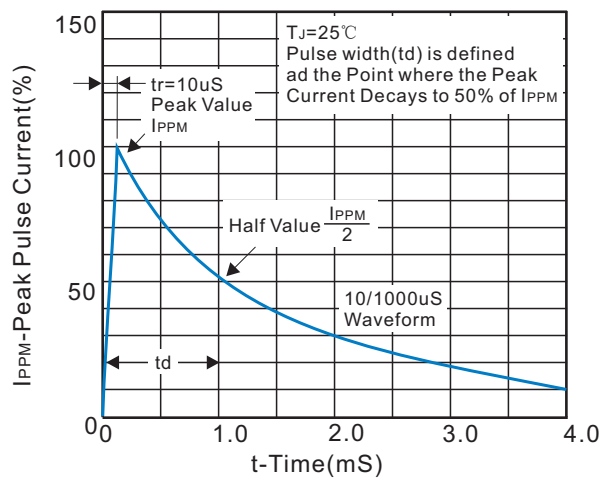

Fig.4 Maximum Non-repetitive Forward Surge

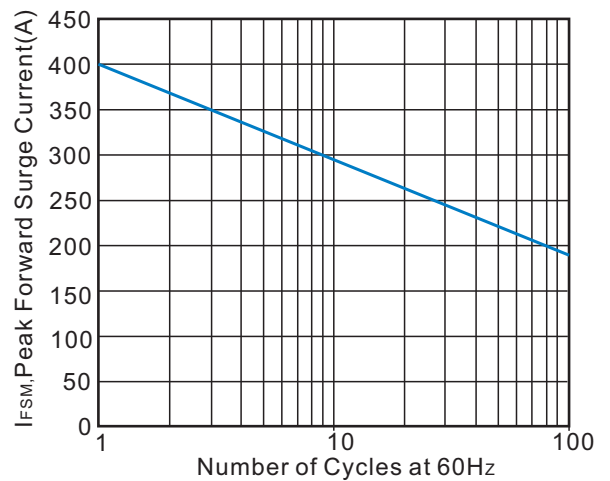

Fig.5 Ri-Vs chart for ISO-16750-2 Test A : 24V System

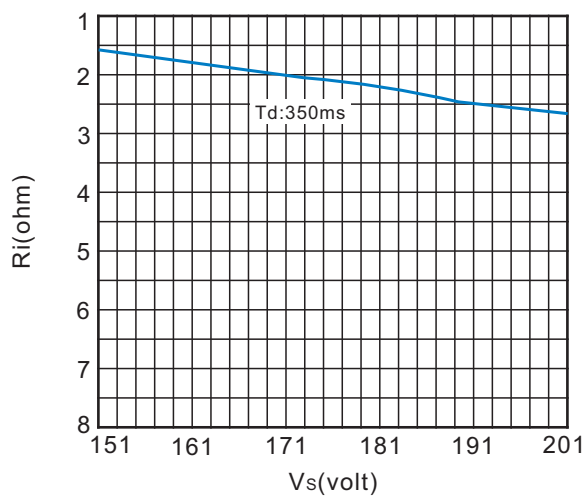
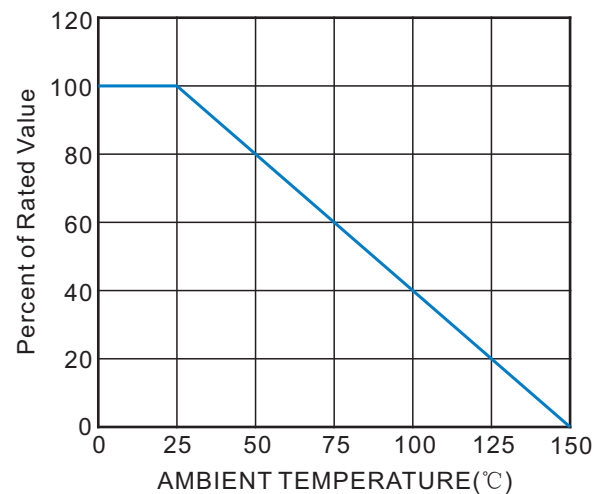

Fig.6 Power Derating Curve



Recommended Soldering Conditions

Recommended Conditions

Reflow Condition		
Pre Heat	-Temperature Min($T_{s(min)}$)	+150°C
	-Temperature Max($T_{s(max)}$)	+200°C
	-Time(Min to Max)(t_s)	60-180secs
Average ramp up rate (Liquidus Temp(T_L) to peak)		3°C/sec.Max.
$T_{s(max)}$ to T_L -Ramp-up Rate		3°C/sec.Max.
Reflow	-Temperature(T_L)(Liquidus)	+217°C
	-Temperature(t_L)	60-150secs
Peak Temp(T_P)		+260(+0/-5)°C
Time within 5°C of actual Peak Temp(t_P)		30 secs.Max.
Ramp-down Rate		6°C/sec.Max.
Time 25°C to Peak Temp(T_P)		8 min.Max.
Do not exceed		+260°C

Reflow Soldering

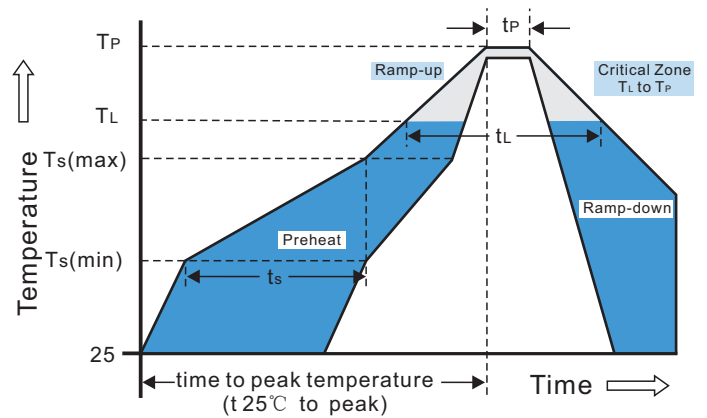

Marking Code

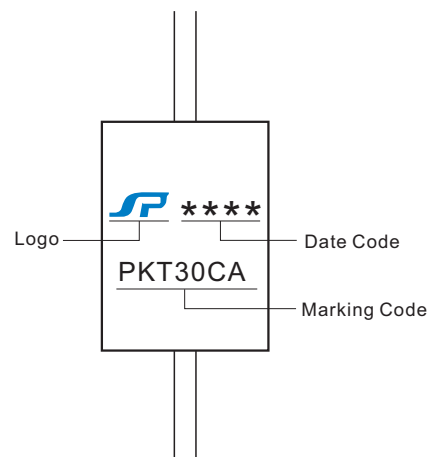
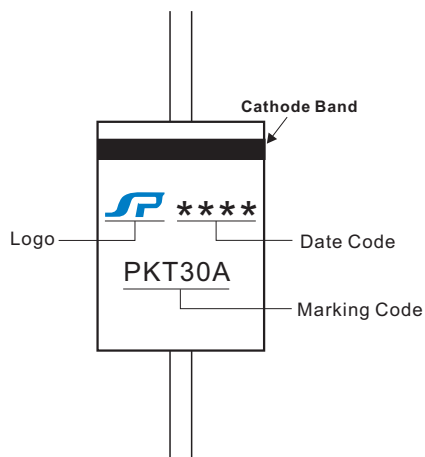

Packaging

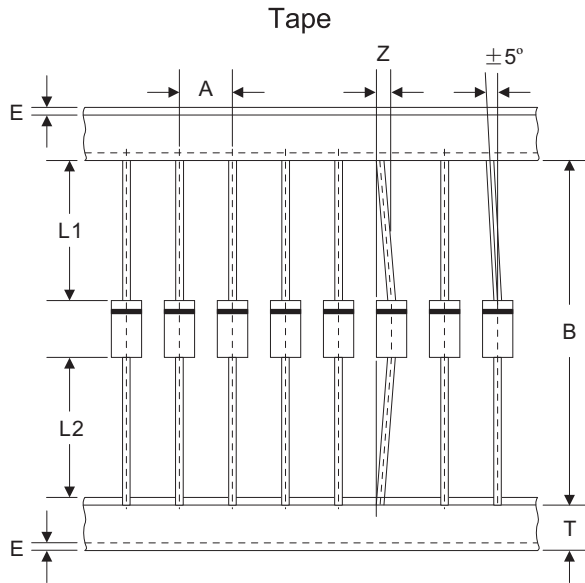

Box

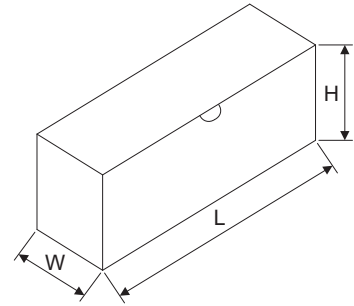

Dimensions in millimeters

A	B	Z	T	E	L1-L2
10.0±0.5	52.0±0.5	1.2Max	6.0±0.4	1.0Max	1.0Max

L	W	H	Quantity
250.0±5.0	78.0±5.0	114.0±5.0	300PCS