

SIGN	DATE	DESCRIPTION	APPROVER
△	11.30	NEW PRODUCT ISSUE	nierzhenqi
△			
△			

NOTES:

1.MATERIAL:

Insulator:Glass filled polyester,UL94V-0.
Contact:Brass.

PLATING:

Contact Area:GOLD PLATING OVER NICKEL.

2.ELECTRICAL

VOLTAGE RATING:250V AC/DC.
CONTACT CURRENT RATING:3 AMP PER PIN.
CONTACT RESISTANCE:20 Milliohms MAXIMUM.
INSULATION RESISTANCE:1000 Megohms MINIMUM.
DIELECTRIC WITHSTANDING VOLTAGE:1000 V r.m.s.

4. ENVIRONMENTAL

TEMPERATURE TANGE: -40° C TO + 105° C.

5.60 and 64P with three key.Others with one key.

231-012-XXX-XOX

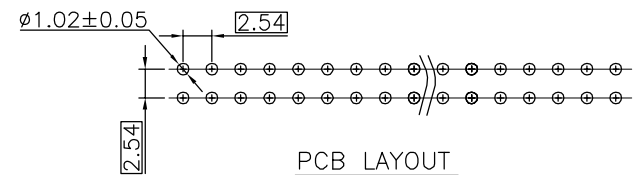
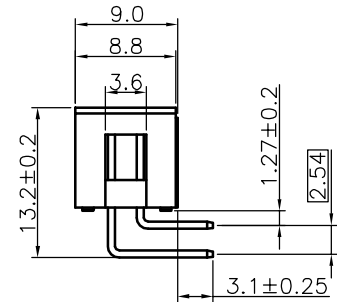
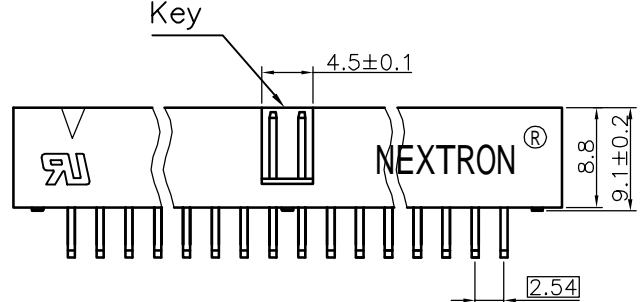
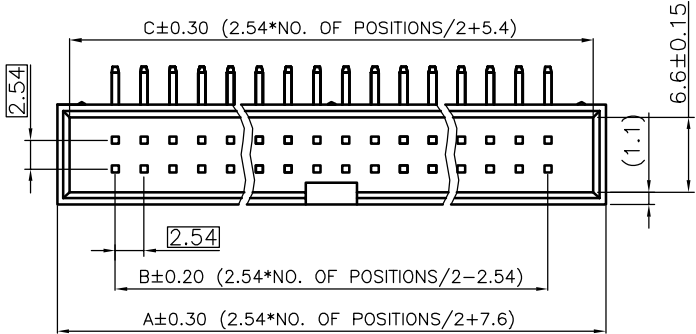
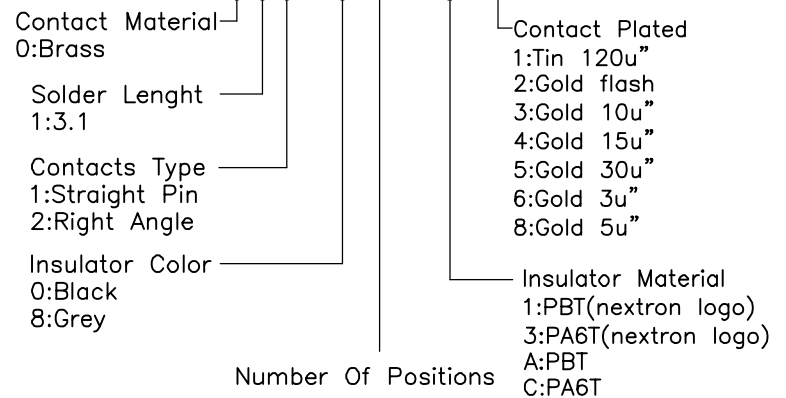

PIN	A±0.30	B±0.20	C±0.30
8	17.76	7.62	15.56
10	20.30	10.16	18.1
14	25.38	15.24	23.18
16	27.92	17.78	25.72
18	30.46	20.32	28.26
20	33.00	22.86	30.80
24	38.08	27.94	35.88
26	40.62	30.48	38.42
30	45.70	35.56	43.50
34	50.78	40.64	48.58
40	58.40	48.26	56.20
50	71.10	60.96	68.90
60	83.80	73.66	81.60
64	88.88	78.74	86.68

nextron 正凌精密工业股份有限公司
NEXTRONICS ENGINEERING CORP

PART. NAME: xxPIN 2.54mm BOX HEADER CONNECTOR				TITLE: 2.54mm BOX HEADER RIGHT ANGLE CONNECTOR	
PART. NO.:				SEE TABLE	
DWG NAME: 231-012-814-106					
APPROVED BY	CHECKED BY	DESIGNED BY	DRAWN BY	CUSTOM NO.:	Tolerance
jeff	jeff		nierzhenqi		x. ±0.50
				UNITS: mm	x.x ±0.20
				SCALE:	x.xx ±0.10
				REVISION:	xx' ±1"