

### Primax

Synonymous with function and performance, enter the Primax, the new era of high intensity illumination in LED. With its high flux output and high luminous intensity, Primax transcends today LED lightings technology and how we perceive it. The small package outline (3.7 x 3.5 x 0.8 mm) and high intensity make it an ideal choice for backlighting, signage, exterior automotive lighting and decorative lighting.



### Features:

- > Super high brightness surface mount LED
- > 120° viewing angle.
- > Compact package outline (LxW) of 3.7 x 3.5 mm.
- > Ultra low height profile - 0.8mm.
- > Low thermal resistance.
- > Compatible to IR reflow soldering.
- > Environmental friendly; RoHS compliance.

### Applications:

- > General lighting.

**Optical Characteristics at Tj=25°C**

Part Ordering Number	Color	Viewing Angle°	CRI Typ.	Luminous Flux @ 100mA (lm) <i>Appx. 1.2</i>		
				Min.	Typ.	Max.
MAF-PSC-7Q7R-1	Warm White	120	82	32.7	39.8	45.2

**Electrical Characteristics at Tj=25°C**

Part Number	Vf @ If = 100 mA <i>Appx. 3.1</i>			Vr @ Ir = 10uA
	Min. (V)	Typ. (V)	Max. (V)	Min. (V)
MAF-PSC	2.7	3.1	3.3	5

**Absolute Maximum Ratings**

	Maximum Value	Unit
DC forward current	180	mA
Peak pulse current	200	mA
Reverse voltage	5	V
ESD threshold (HBM)	2000	V
LED junction temperature	150	°C
Operating temperature	-40 ... +125	°C
Storage temperature	-40 ... +125	°C
Thermal resistance		
- Junction / ambient, R <sub>th JA</sub>	90	K/W
- Junction / solder point, R <sub>th JS</sub>	18	K/W
(Mounted on dual sided FR4 in house PCB, total Cu area >900mm <sup>2</sup> )		

**Characteristics**

	<b>Symbol</b>	<b>Part Number</b>	<b>Value</b>	<b>Unit</b>
Temperature coefficient of $V_F$ (typ) $I_F = 100\text{mA}; 0\text{ }^\circ\text{C} \leq T \leq 100\text{ }^\circ\text{C}$	$TC_V$	MAF-PSC	-3.00	mV / K
Temperature coefficient of $I_V$ (typ) $I_F = 100\text{mA}; 0\text{ }^\circ\text{C} \leq T \leq 100\text{ }^\circ\text{C}$	$TC_{IV}$	MAF-PSC	-0.08	% / K
Temperature coefficient of $C_x$ (typ) $I_F = 100\text{mA}; 0\text{ }^\circ\text{C} \leq T \leq 100\text{ }^\circ\text{C}$	$TC_{Cx}$	MAF-PSC	-0.00005	
Temperature coefficient of $C_y$ (typ) $I_F = 100\text{mA}; 0\text{ }^\circ\text{C} \leq T \leq 100\text{ }^\circ\text{C}$	$TC_{Cy}$	MAF-PSC	-0.00006	

**MAF-PSC, Color Grouping** *Appx. 2.1*

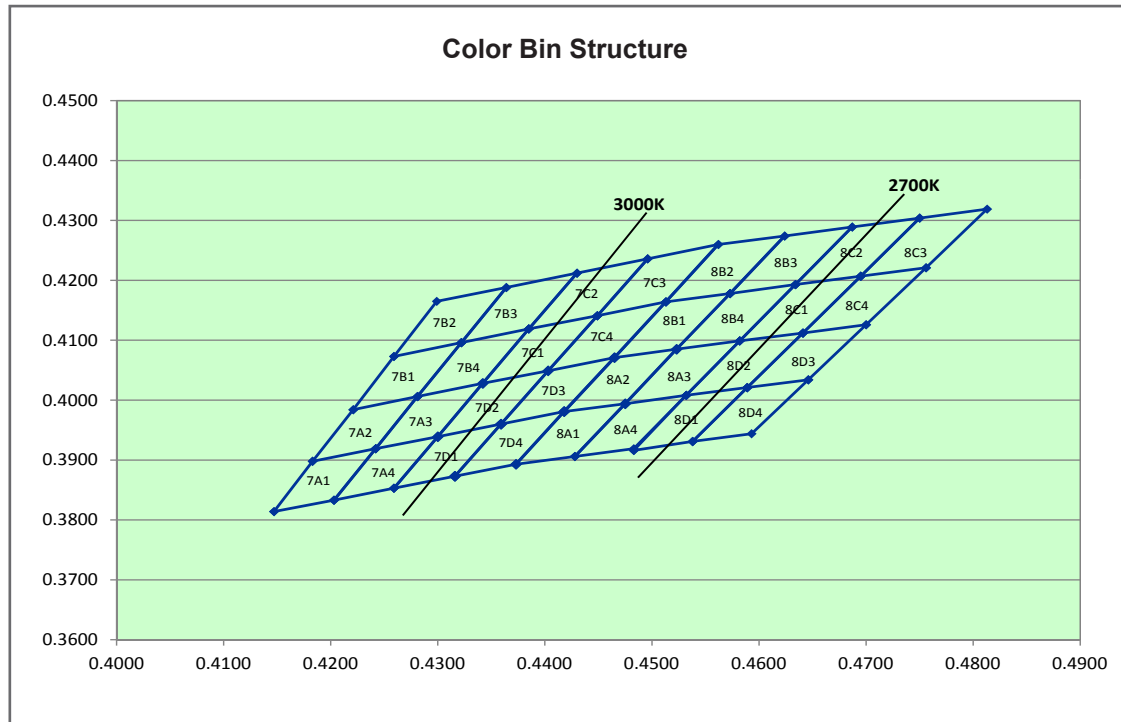

Bin		1	2	3	4
7A1	Cx	0.4147	0.4183	0.4242	0.4203
	Cy	0.3814	0.3898	0.3919	0.3833
7A2	Cx	0.4183	0.4221	0.4281	0.4242
	Cy	0.3898	0.3984	0.4006	0.3919
7A3	Cx	0.4242	0.4281	0.4342	0.4300
	Cy	0.3919	0.4006	0.4028	0.3939
7A4	Cx	0.4203	0.4242	0.4300	0.4259
	Cy	0.3833	0.3919	0.3939	0.3853
7B1	Cx	0.4221	0.4259	0.4322	0.4281
	Cy	0.3984	0.4073	0.4096	0.4006
7B2	Cx	0.4259	0.4299	0.4364	0.4322
	Cy	0.4073	0.4165	0.4188	0.4096
7B3	Cx	0.4322	0.4364	0.4430	0.4385
	Cy	0.4096	0.4188	0.4212	0.4119
7B4	Cx	0.4281	0.4322	0.4385	0.4342
	Cy	0.4006	0.4096	0.4119	0.4028
7C1	Cx	0.4342	0.4385	0.4449	0.4403
	Cy	0.4028	0.4119	0.4141	0.4049
7C2	Cx	0.4385	0.4430	0.4496	0.4449
	Cy	0.4119	0.4212	0.4236	0.4141
7C3	Cx	0.4449	0.4496	0.4562	0.4513
	Cy	0.4141	0.4236	0.4260	0.4164
7C4	Cx	0.4403	0.4449	0.4513	0.4465
	Cy	0.4049	0.4141	0.4164	0.4071

<b>Bin</b>		<b>1</b>	<b>2</b>	<b>3</b>	<b>4</b>
7D1	Cx	0.4259	0.4300	0.4359	0.4316
	Cy	0.3853	0.3939	0.3960	0.3873
7D2	Cx	0.4300	0.4342	0.4403	0.4359
	Cy	0.3939	0.4028	0.4049	0.3960
7D3	Cx	0.4359	0.4403	0.4465	0.4418
	Cy	0.3960	0.4049	0.4071	0.3981
7D4	Cx	0.4316	0.4359	0.4418	0.4373
	Cy	0.3873	0.3960	0.3981	0.3893
8A1	Cx	0.4373	0.4418	0.4475	0.4428
	Cy	0.3893	0.3981	0.3994	0.3906
8A2	Cx	0.4418	0.4465	0.4523	0.4475
	Cy	0.3981	0.4071	0.4085	0.3994
8A3	Cx	0.4475	0.4523	0.4582	0.4532
	Cy	0.3994	0.4085	0.4099	0.4008
8A4	Cx	0.4428	0.4475	0.4532	0.4483
	Cy	0.3906	0.3994	0.4008	0.3919
8B1	Cx	0.4465	0.4513	0.4573	0.4523
	Cy	0.4071	0.4164	0.4178	0.4085
8B2	Cx	0.4513	0.4562	0.4624	0.4573
	Cy	0.4164	0.4260	0.4274	0.4178
8B3	Cx	0.4573	0.4624	0.4687	0.4634
	Cy	0.4178	0.4274	0.4289	0.4193
8B4	Cx	0.4523	0.4573	0.4634	0.4582
	Cy	0.4085	0.4178	0.4193	0.4099
8C1	Cx	0.4582	0.4634	0.4695	0.4641
	Cy	0.4099	0.4193	0.4207	0.4112
8C2	Cx	0.4634	0.4687	0.4750	0.4695
	Cy	0.4193	0.4289	0.4304	0.4207
8C3	Cx	0.4695	0.4750	0.4813	0.4756
	Cy	0.4207	0.4304	0.4319	0.4221
8C4	Cx	0.4641	0.4695	0.4756	0.4700
	Cy	0.4112	0.4207	0.4221	0.4126
8D1	Cx	0.4483	0.4532	0.4589	0.4538
	Cy	0.3916	0.4008	0.4021	0.3931
8D2	Cx	0.4532	0.4582	0.4641	0.4589
	Cy	0.4008	0.4099	0.4112	0.4021
8D3	Cx	0.4589	0.4641	0.4700	0.4646
	Cy	0.4021	0.4112	0.4126	0.4034
8D4	Cx	0.4538	0.4589	0.4646	0.4593
	Cy	0.3931	0.4021	0.4034	0.3944

InGaN wavelength is very sensitive to drive current. Operating at lower current is not recommended and may yield unpredictable performance current pulsing should be used for dimming purposed.

MAF-PSC, Color Grouping *Appx. 2.1*

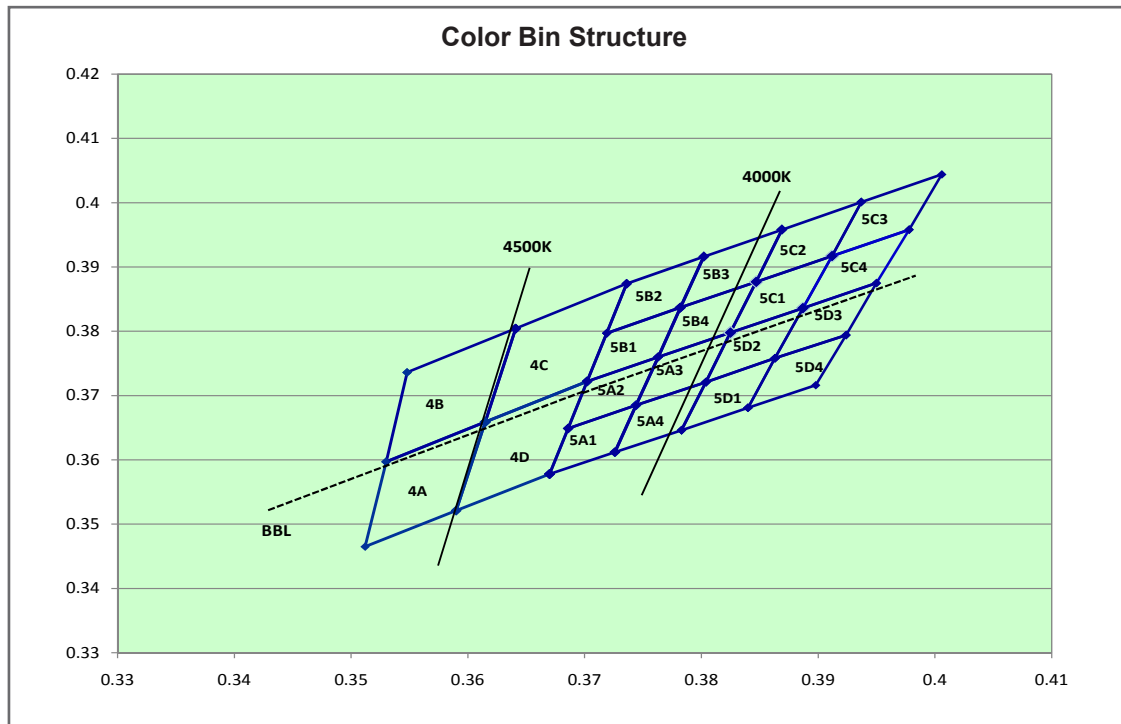

Bin		1	2	3	4
4A	Cx	0.3530	0.3615	0.3590	0.3512
	Cy	0.3597	0.3659	0.3521	0.3465
4B	Cx	0.3548	0.3641	0.3615	0.3530
	Cy	0.3736	0.3804	0.3659	0.3597
4C	Cx	0.3641	0.3736	0.3702	0.3615
	Cy	0.3804	0.3874	0.3722	0.3659
4D	Cx	0.3615	0.3702	0.3670	0.3590
	Cy	0.3659	0.3722	0.3578	0.3521
5A1	Cx	0.3670	0.3686	0.3744	0.3726
	Cy	0.3578	0.3649	0.3685	0.3612
5A2	Cx	0.3686	0.3702	0.3763	0.3744
	Cy	0.3649	0.3722	0.3760	0.3685
5A3	Cx	0.3744	0.3763	0.3825	0.3804
	Cy	0.3685	0.3760	0.3798	0.3721
5A4	Cx	0.3726	0.3744	0.3804	0.3783
	Cy	0.3612	0.3685	0.3721	0.3646
5B1	Cx	0.3702	0.3719	0.3782	0.3763
	Cy	0.3722	0.3797	0.3837	0.3760
5B2	Cx	0.3719	0.3736	0.3802	0.3782
	Cy	0.3797	0.3874	0.3916	0.3837
5B3	Cx	0.3782	0.3802	0.3869	0.3847
	Cy	0.3837	0.3916	0.3958	0.3877
5B4	Cx	0.3763	0.3782	0.3847	0.3825
	Cy	0.3760	0.3837	0.3877	0.3798

Bin		1	2	3	4
5C1	Cx	0.3825	0.3847	0.3912	0.3887
	Cy	0.3798	0.3877	0.3917	0.3836
5C2	Cx	0.3847	0.3869	0.3937	0.3912
	Cy	0.3877	0.3958	0.4001	0.3917
5C3	Cx	0.3912	0.3937	0.4006	0.3978
	Cy	0.3917	0.4001	0.4044	0.3958
5C4	Cx	0.3887	0.3912	0.3978	0.3950
	Cy	0.3836	0.3917	0.3958	0.3875
5D1	Cx	0.3783	0.3804	0.3863	0.3840
	Cy	0.3646	0.3721	0.3758	0.3681
5D2	Cx	0.3804	0.3825	0.3887	0.3863
	Cy	0.3721	0.3798	0.3836	0.3758
5D3	Cx	0.3863	0.3887	0.3950	0.3924
	Cy	0.3758	0.3836	0.3875	0.3794
5D4	Cx	0.3840	0.3863	0.3924	0.3898
	Cy	0.3681	0.3758	0.3794	0.3716

InGaN wavelength is very sensitive to drive current. Operating at lower current is not recommended and may yield unpredictable performance current pulsing should be used for dimming purposed.

**Luminous Intensity Group at Tj=25°C**

Brightness Group	Luminous Flux (lm) <i>Appx. 1.2</i>
7Q	32.7 ... 34.8
8Q	34.8 ... 37.3
9Q	37.3 ... 39.8
6R	39.8 ... 42.5
7R	42.5 ... 45.2

**Vf Binning**

Vf Bin @ 100mA	Forward Voltage (V) <i>Appx. 3.1</i>
V1	2.70 ... 2.80
V2	2.80 ... 2.90
V3	2.90 ... 3.00
V4	3.00 ... 3.10
V5	3.10 ... 3.20
V6	3.20 ... 3.30



Relative Flux Vs Forward Current

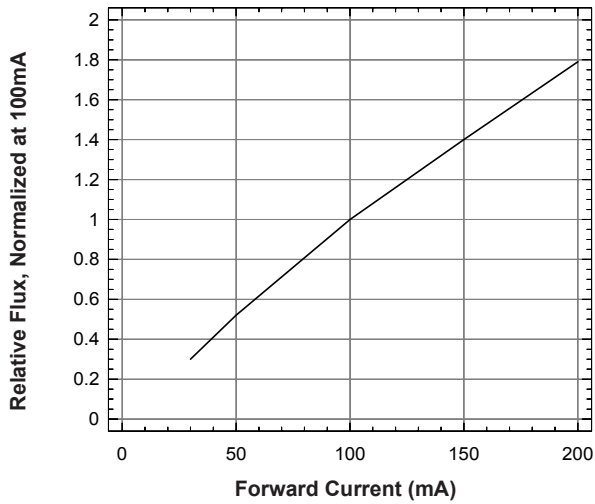

Forward Voltage Vs Forward Current

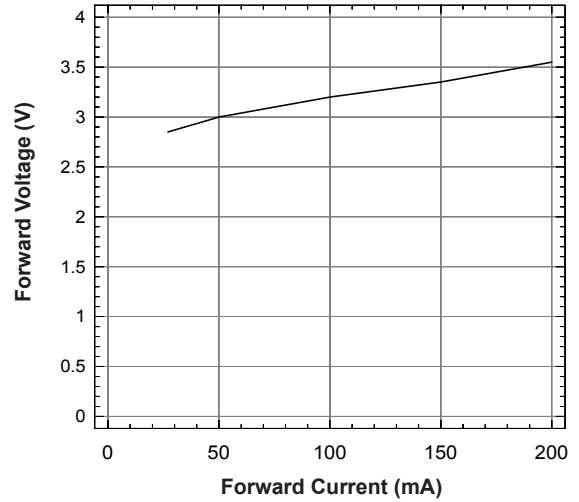

Relative Intensity Vs Wavelength

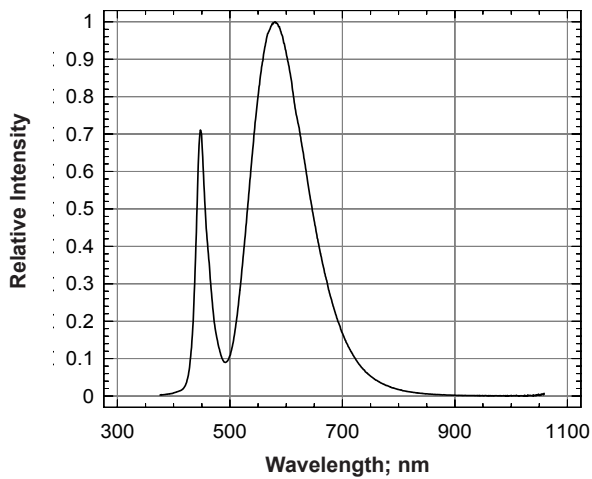

Forward Current Vs Ambient Temperature

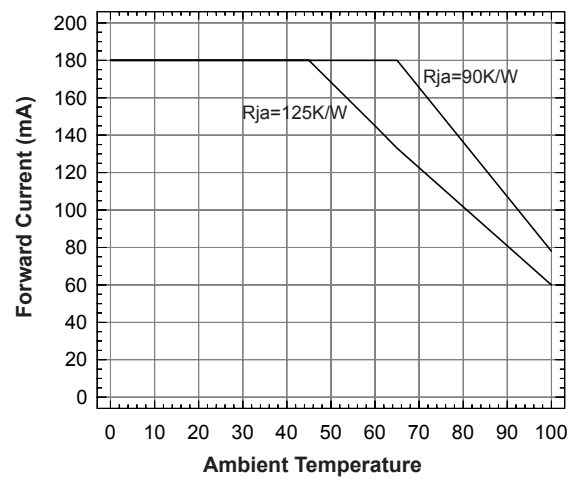

Radiation Pattern

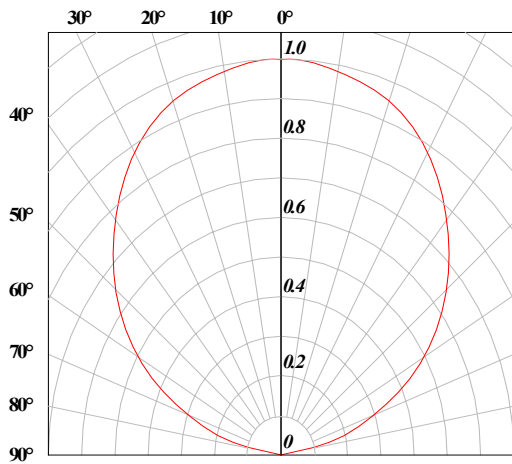

**PrimaxPlus • 100 InGaN Warm White: MAF-PSC Package Outlines**

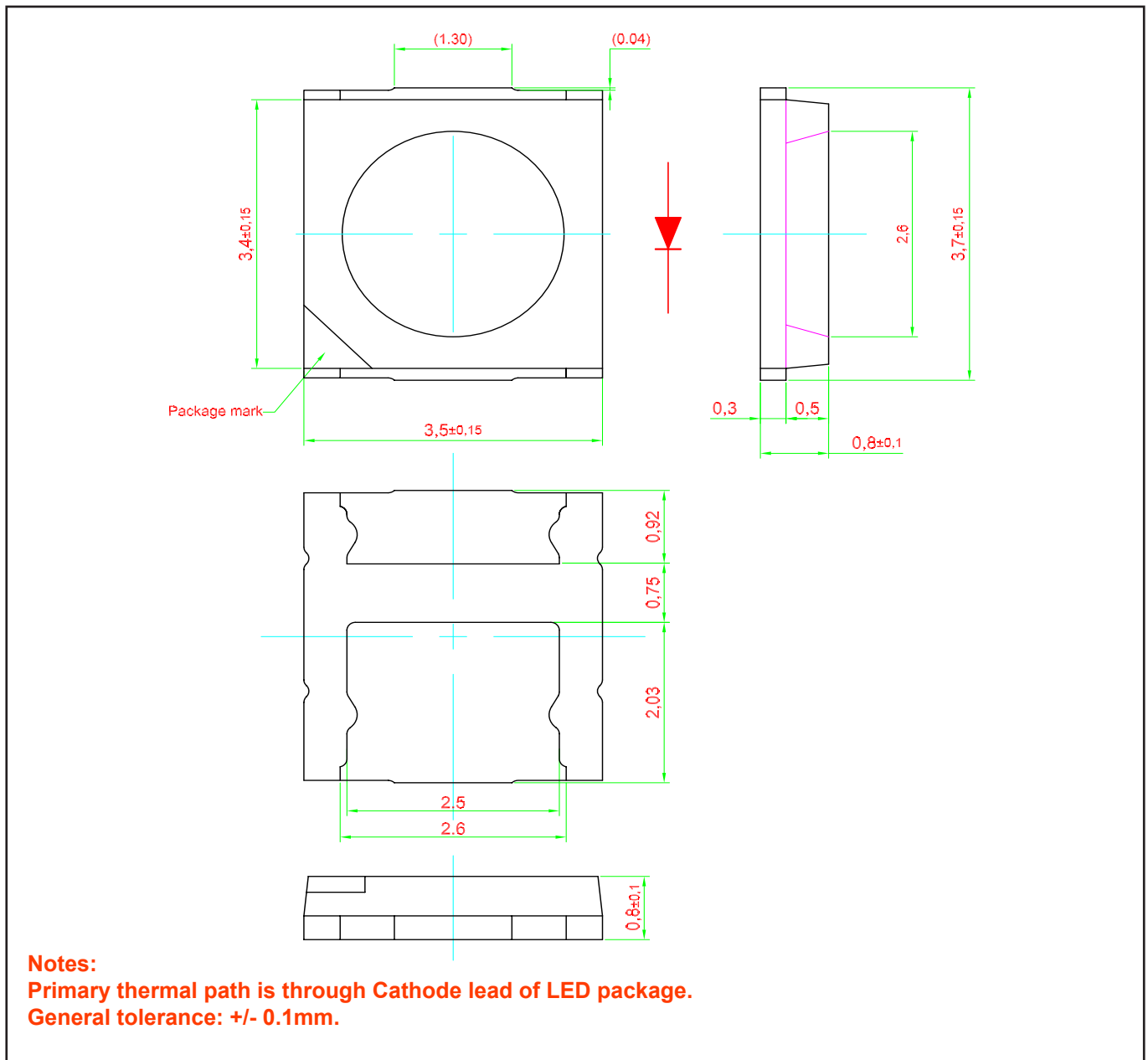

**Material**

Material	
Lead-frame	Cu Alloy With Ag Plating
Package	High Temperature Resistant Plastic
Encapsulant	Silicone Resin
Soldering Leads	Ag Plating

Note: This product is Pb free

**Recommended Solder Pad**

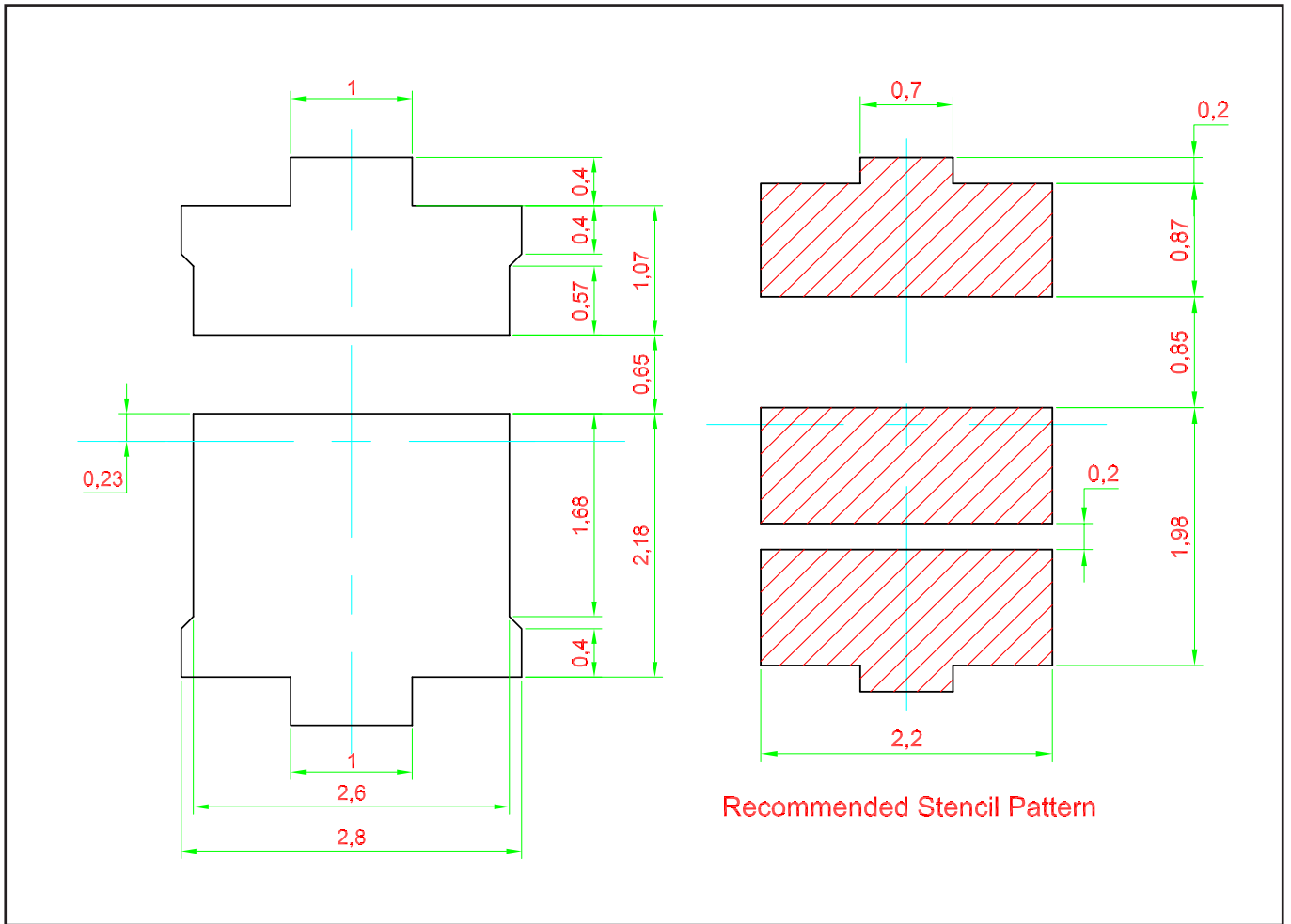

### Taping and orientation

- Reels come in quantity of 1000 units.
- Reel diameter is 180 mm.

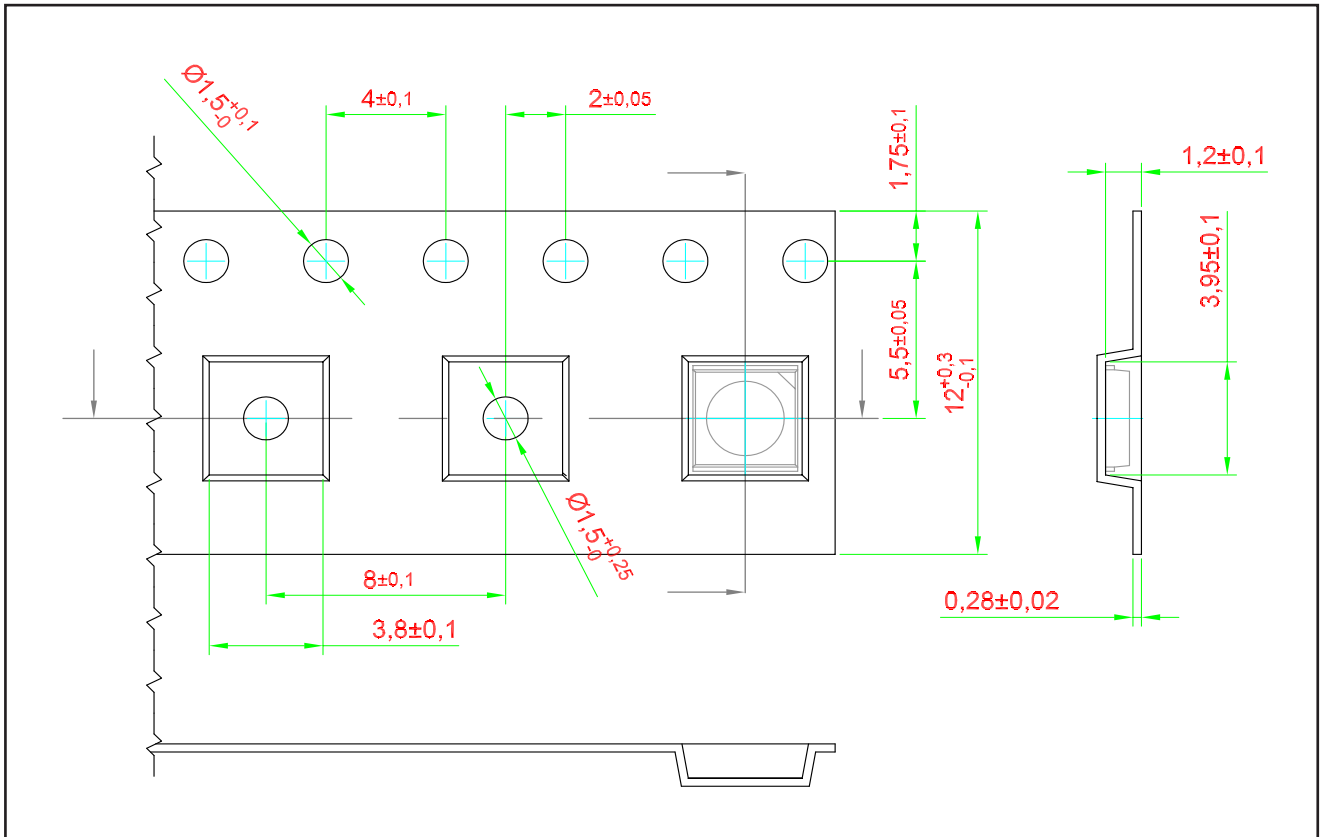

### Packaging Specification

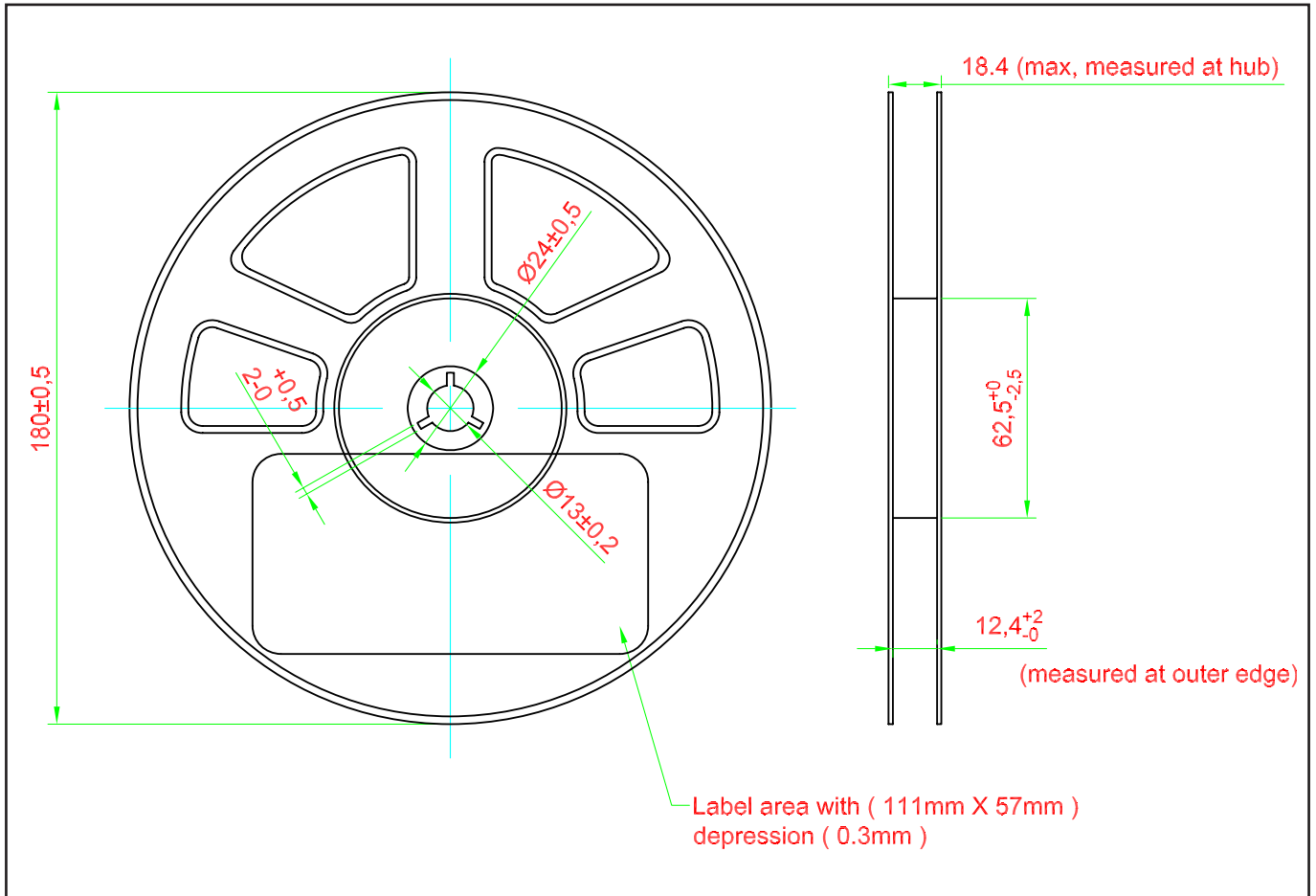

**Packaging Specification**

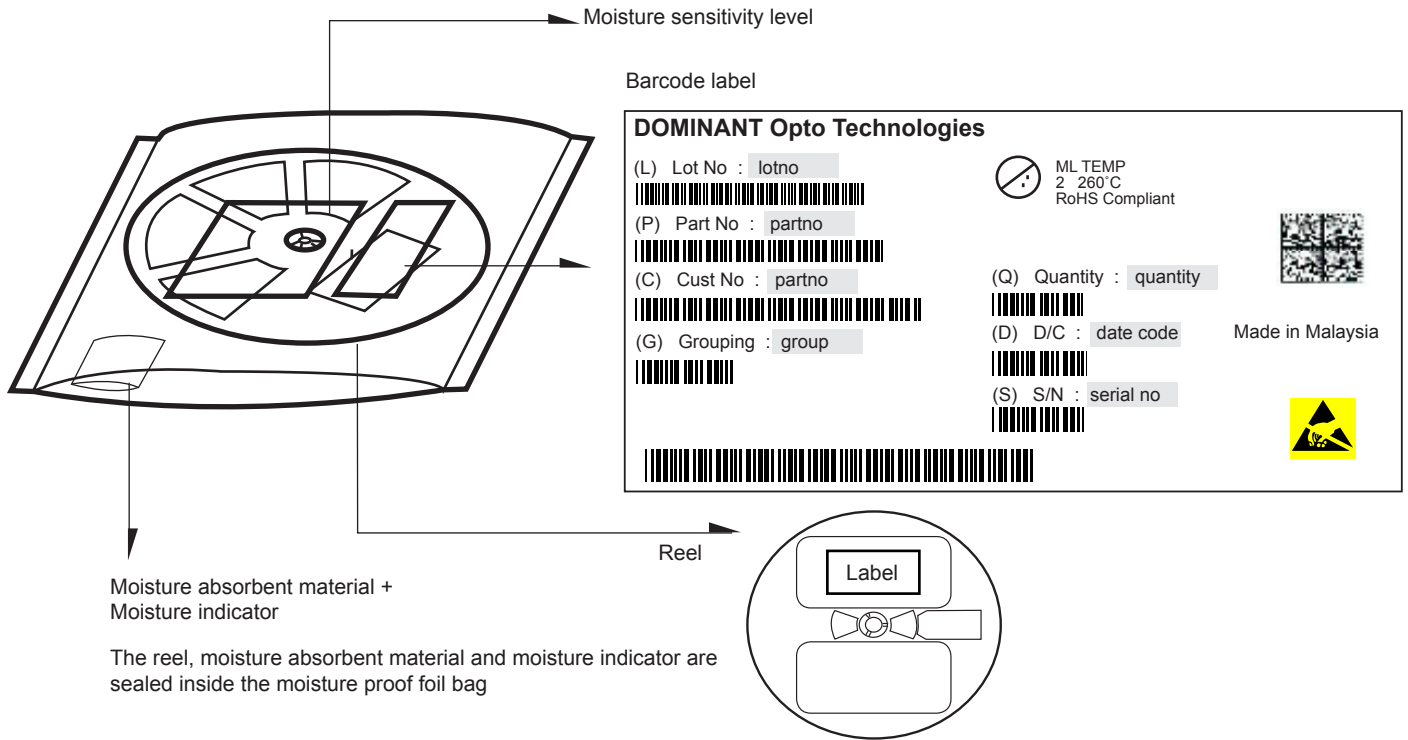

	Average 1pc PrimaxPlus	1 completed bag (1000pcs)
<b>Weight (gram)</b>	<b>0.034</b>	<b>230 ± 10</b>

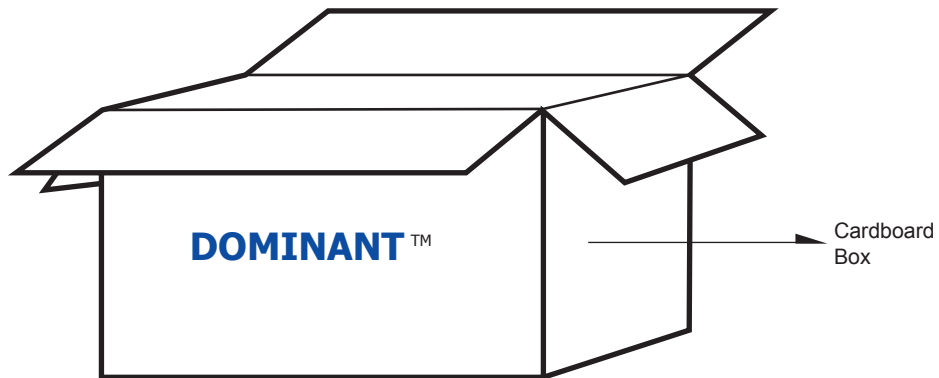

**For PrimaxPlus**

Cardboard Box Size	Dimensions (mm)	Empty Box Weight (kg)	Reel / Box
Super Small	325 x 225 x 190	0.38	7 reels MAX
Small	325 x 225 x 280	0.54	11 reels MAX
Medium	570 x 440 x 230	1.46	48 reels MAX
Large	570 x 440 x 460	1.92	96 reels MAX

**Recommended Pb-free Soldering Profile**

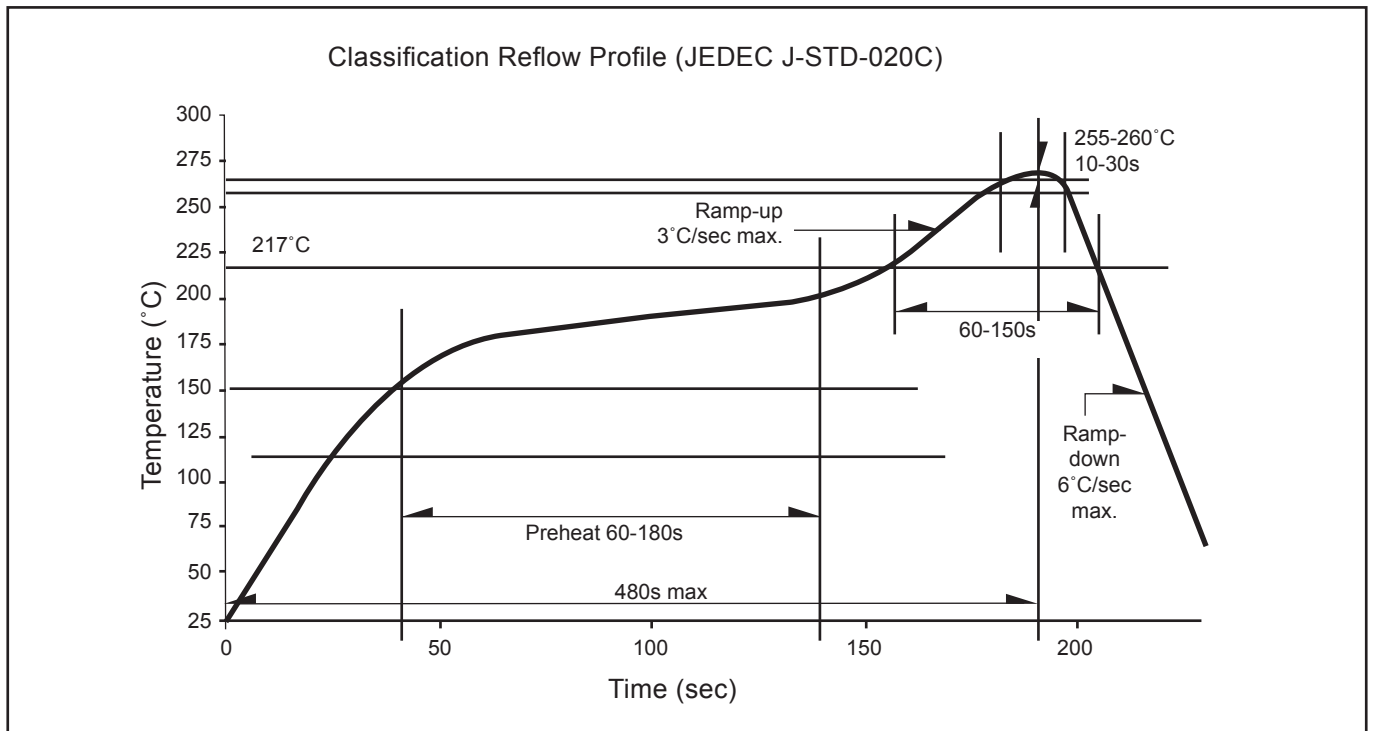

## Appendix

### 1) **Brightness:**

- 1.1 Luminous intensity is measured with an internal reproducibility of  $\pm 8 \%$  and an expanded uncertainty of  $\pm 11 \%$  (according to GUM with a coverage factor of  $k=3$ ).
- 1.2 Luminous flux is measured with an internal reproducibility of  $\pm 8 \%$  and an expanded uncertainty of  $\pm 11 \%$  (according to GUM with a coverage factor of  $k=3$ ).

### 2) **Color:**

- 2.1 Chromaticity coordinate groups are measured with an internal reproducibility of  $\pm 0.005$  and an expanded uncertainty of  $\pm 0.01$  (accordingly to GUM with a coverage factor of  $k=3$ ).
- 2.2 DOMINANT wavelength is measured with an internal reproducibility of  $\pm 0.5\text{nm}$  and an expanded uncertainty of  $\pm 1\text{nm}$  (accordingly to GUM with a coverage factor of  $k=3$ ).

### 3) **Voltage:**

- 3.1 Forward Voltage,  $V_f$  is measured with an internal reproducibility of  $\pm 0.05\text{V}$  and an expanded uncertainty of  $\pm 0.1\text{V}$  (accordingly to GUM with a coverage factor of  $k=3$ ).



**Revision History**

<b>Page</b>	<b>Subjects</b>	<b>Date of Modification</b>
-	Initial Release	14 Nov 2013
2, 4	Add Thermal Resistance Update on graph	12 Feb 2014
3	Add Characteristics	17 Mar 2015
10, 11, 14, 16	Update Package Outline Update Recommended Solder Pad Update Package Specification Add Appendix	17 Mar 2017
10	Update Package Outline	17 May 2017

**NOTE**

All the information contained in this document is considered to be reliable at the time of publishing. However, DOMINANT Opto Technologies does not assume any liability arising out of the application or use of any product described herein.

DOMINANT Opto Technologies reserves the right to make changes to any products in order to improve reliability, function or design.

DOMINANT Opto Technologies products are not authorized for use as critical components in life support devices or systems without the express written approval from the Managing Director of DOMINANT Opto Technologies.

## About Us

DOMINANT Opto Technologies is a dynamic company that is amongst the world's leading automotive LED manufacturers. With an extensive industry experience and relentless pursuit of innovation, DOMINANT's state-of-art manufacturing and development capabilities have become a trusted and reliable brand across the globe. More information about DOMINANT Opto Technologies, a ISO/TS 16949 and ISO 14001 certified company, can be found under <http://www.dominant-semi.com>.

### **Please contact us for more information:**

DOMINANT Opto Technologies Sdn. Bhd  
Lot 6, Batu Berendam, FTZ Phase III, 75350 Melaka, Malaysia.  
Tel: +606 283 3566 Fax: +606 283 0566  
E-mail: [sales@dominant-semi.com](mailto:sales@dominant-semi.com)

---