

35

3501

RAST 2.5 connectors, pitch 2.5/5.0 mm



RAST 2.5 guide frame, for interior locking

State: Active

Approvals:  

35

3501

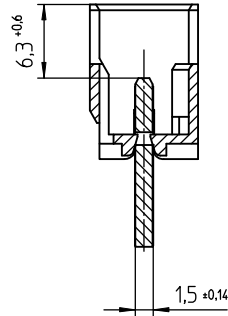
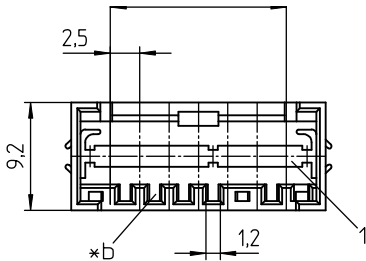
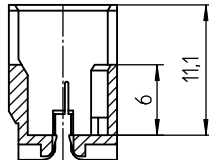
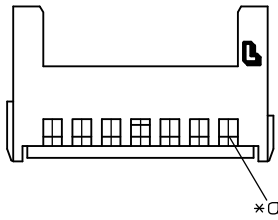

Environmental conditions

Temperature range -40 °C/+130 °C¹

¹ upper limit temperature (insulating body) RTI (electrical) of the UL Yellow Card

Materials













Component PBT GF, V-0 according to UL94

Mechanical data

Locking on Leiterplatte 1,5 ± 0,14 mm
Keying proposals at www.lumberg.com 

Associated products

Accessories

 3520	 3520	 3520-1
 3520-1	 3520-2	 3520-2
 3522	 3522	 3522-1
 3522-1	 3522-2	 3522-2

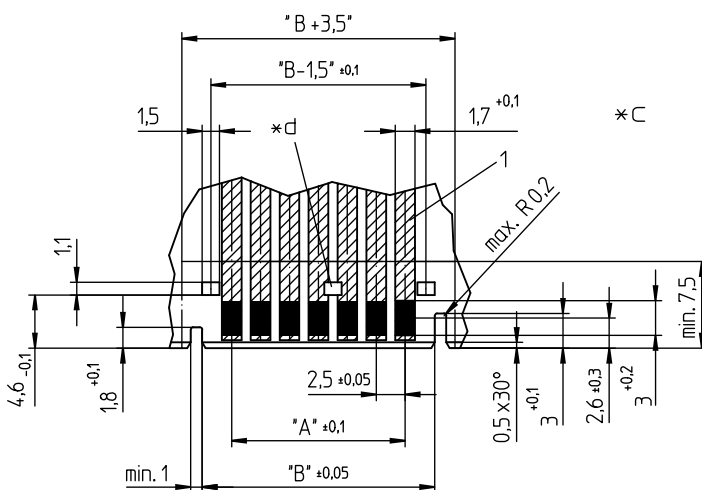

- *a test hole
- *b keying
- *c example for printed circuit board layout
- *d positions of additional locking windows (see table of dimensions)

Designation	Pole Number	PU (Pieces)	MDQ (Pieces)	Dimensions		
				A (mm)	B (mm)	*d (mm)
3501 03	3	1000	3000	5.0	10.1	-
3501 04	4	1000	3000	7.5	12.6	-
3501 05	5	1000	3000	10.0	15.1	-
3501 06	6	500	3000	12.5	17.6	-
3501 07	7	500	3000	15.0	20.1	3/4
3501 08	8	500	3000	17.5	22.6	4/5
3501 09	9	500	3000	20.0	25.1	4/5
3501 10	10	500	3000	22.5	27.6	5/6
3501 11	11	250	3000	25.0	30.1	5/6
3501 12	12	250	3000	27.5	32.6	6/7
3501 13	13	250	3000	30.0	35.1	6/7
3501 14	14	250	3000	32.5	37.6	4/5, 10/11
3501 15	15	250	3000	35.0	40.1	4/5, 11/12
3501 16	16	250	3000	37.5	42.6	5/6, 11/12
3501 17	17	250	3000	40.0	45.1	5/6, 12/13
3501 18	18	250	3000	42.5	47.6	5/6, 13/14
3501 19	19	250	3000	45.0	20.1	6/7, 13/14
3501 20	20	250	3000	47.5	52.6	6/7, 14/15

Designation to be completed by further details (e.g. for keying, color or material options).

Packaging:

in bulk, in a cardboard box