

# VL CONNECTOR

6.2mm pitch/Disconnectable Crimp style connectors

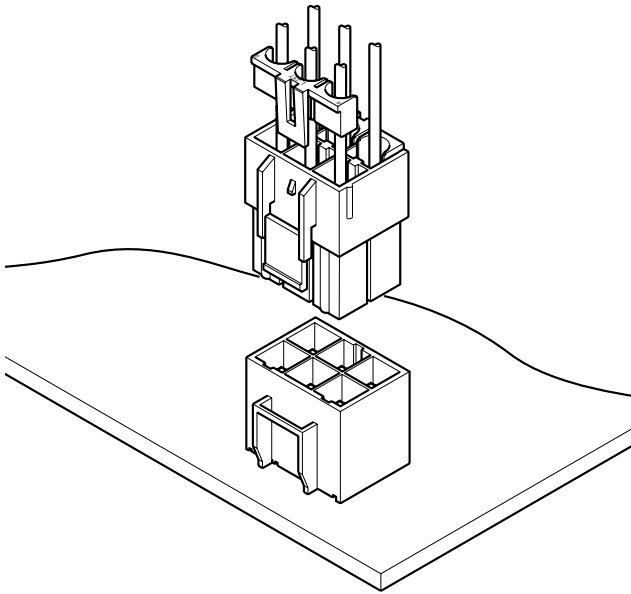

**This VL connector is designed for wire-to-wire and wire-to-board 6.2mm pitch connector corresponding to large current. Secondary retainer, which prevents from insufficient insertion of contact and coming off contact, may use and large current circuit can be connected certainly and safety.**

- Housing lances for contact retention
- Secondary retainer
- Suited for large current
- Two kinds of connections

## Specifications

- Current rating: 20A AC, DC (Refer to the table below.)
- Voltage rating: 600V AC, DC
- Temperature range: -25°C to +90°C (including temperature rise in applying electrical current)
- Contact resistance: Initial value/7m Ω max. After environmental testing/10m Ω max.
- Insulation resistance: 1,000M Ω min.
- Withstanding voltage: 2,000V AC/minute
- Applicable wire: AWG #22 to #12
- Applicable PC board thickness: 1.6mm
- \* Compliant with RoHS.
- \* Refer to "General Instruction and Notice when using Terminals and Connectors" at the end of this catalog.
- \* Contact JST for details.

Note: The current rating differs depending on the number of circuits and the wire size used in each connector. The table below lists the current rating as a function of the number of circuits and the wire size.

Circuits	Wire size(AWG)					Current unit:A
	# 12	# 14	# 16	# 18	# 20	# 22
2	20	15	10	8	6	4
3	17	14	9	8	6	4
4	16	13	9	7	6	4
6	15	12	8	7	5	3
8	14	11	7	6	5	3
12	13	10	7	6	4	3

Note: Do not branch in parallel current which exceeds the rated current (eg. more than 17A in the case of 3 circuits with AWG #12). If branched in parallel, current imbalance or other problems may develop. If it is absolutely necessary to branch such a large current in parallel, design the circuits without causing any imbalance and provide an extra margin for each circuit.

## Standards

- Recognized E60389
- Certified LR20812
- R9351103

## PC board layout (viewed from soldering side) and Assembly layout

(2, 3, Single-row 4 circuits)

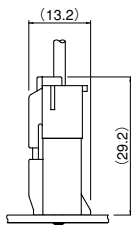
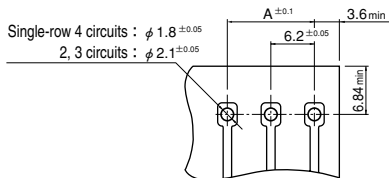

<Inner-housing lock>

<Outer-housing lock>

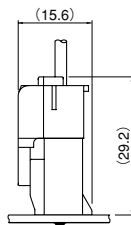

(4, 6, 8, 12 circuits)

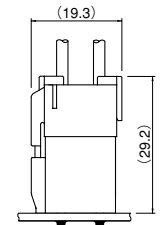
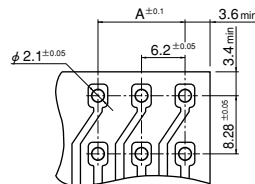

<Inner-housing lock>

<Outer-housing lock>

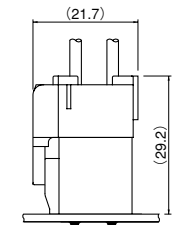

Note: 1. Tolerances are non-cumulative: ±0.05mm for all centers.

2. Hole dimensions differ according to the kind of PC board and piercing method. The dimensions above should serve as a guideline. Contact JST for details.

# VL CONNECTOR

## Contact

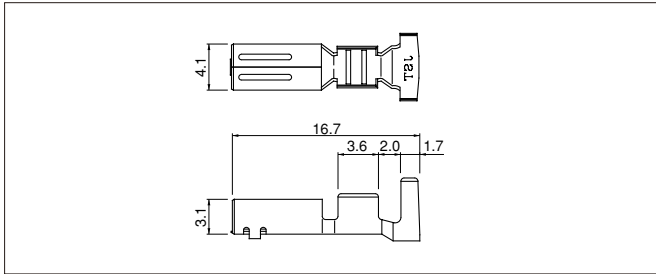

Model No.	Applicable wire		Insulation O.D.(mm)	Q'ty / reel
	mm <sup>2</sup>	AWG #		
<b>*SVF-42T-P2.0</b>	0.3~1.25	22~16	1.7~3.2	2,000
<b>SVF-61T-P2.0</b>	0.5~2.0	20~14	1.9~3.4	2,000
<b>SVF-81T-P2.0</b>	3.5	12	4.1	2,000

### Material and Finish

Phosphor bronze, tin-plated (reflow treatment)

### RoHS compliance

Note: \*Marked product is not TÜV approved.

Contact	Crimping machine	Applicator		
		Crimp applicator	Dies	Crimp applicator with dies
<b>SVF-42T-P2.0</b>	AP-K2N	MKS-L	MK/SVF/M-42-20	APLMK SVF/M42-20
		—	—	—
<b>SVF-61T-P2.0</b>	AP-K2N	MKS-L	MK/SVF/M-61-20	APLMK SVF/M61-20
		—	—	—

Contact	Crimping machine	Applicator		
		Crimp applicator	Dies	Crimp applicator with dies
<b>SVF-81T-P2.0</b>	AP-K2N	MKS-L	MK/SVF/M-81-20	APLMK SVF/M81-20
		—	—	—

## Housing (Inner-housing lock)

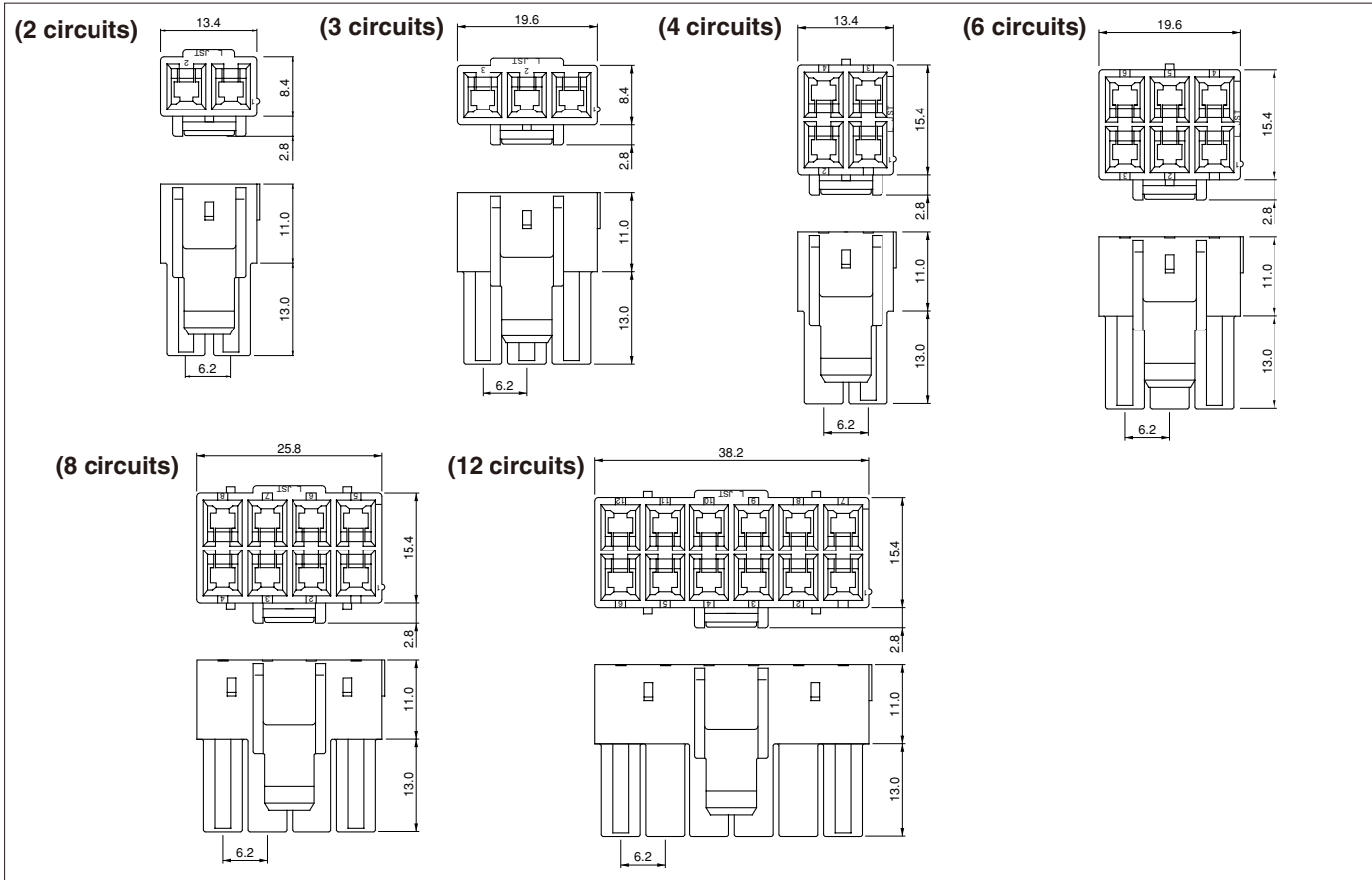

Circuits	Model No.	Q'ty / bag
2	<b>VLP-02V</b>	500
3	<b>VLP-03V</b>	500
4	<b>VLP-04V</b>	500
6	<b>VLP-06V</b>	500
8	<b>VLP-08V</b>	200
12	<b>VLP-12V</b>	100

### Material

PA 66, UL94V-0, natural (white)

RoHS compliance

# VL CONNECTOR

## Housing (Outer-housing lock)

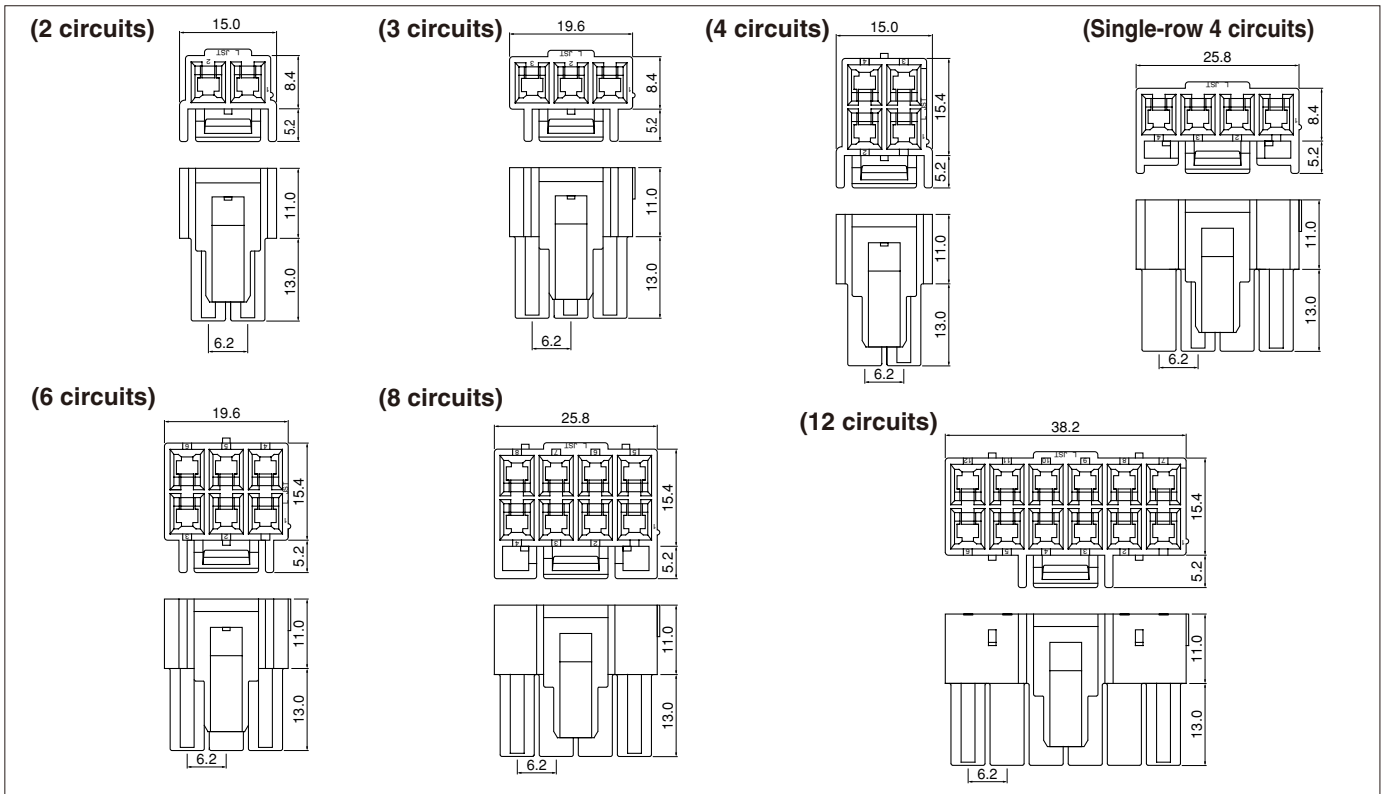

Circuits	Model No.	Q'ty / bag
2	VLP-02V-1	500
3	VLP-03V-1	500
4	VLP-04V-1	500
4 (single-row)	VLP-04VN-1	500
6	VLP-06V-1	500
8	VLP-08V-1	200
12	VLP-12V-1	100

### Material

PA 66, UL94V-0, natural (white)

### RoHS compliance

## Retainer

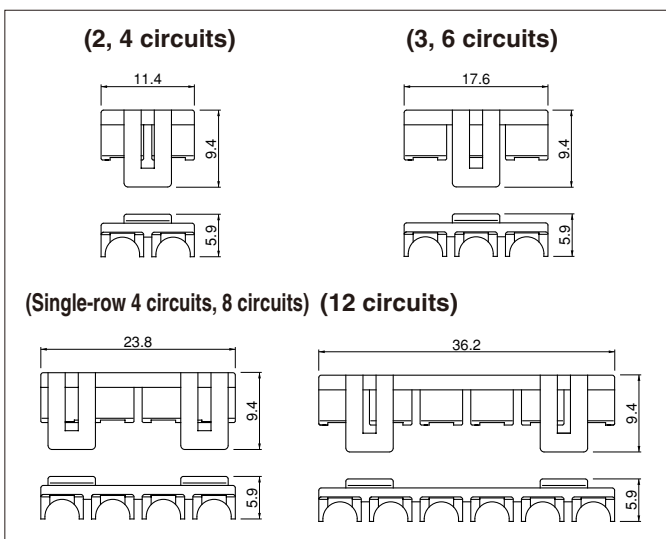

Circuits	Model No.	Q'ty / bag
2, 4	VLS-02V	1,000
3, 6	VLS-03V	1,000
4 (single-row), 8	VLS-08V	1,000
12	VLS-12V	1,000

### Material

Glass-filled PA 66, UL94V-0, natural (ivory)

### RoHS compliance

# VL CONNECTOR

## Shrouded header

(2, 3 circuits)

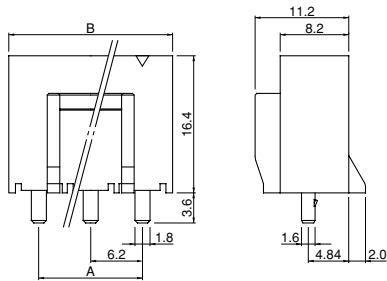

(4, 6 circuits)

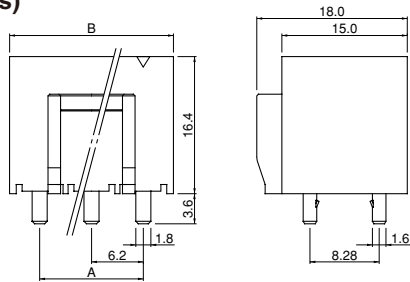

(Single-row 4 circuits)

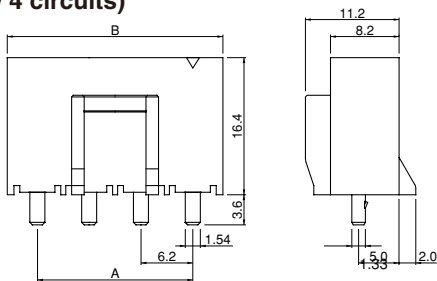

(8, 12 circuits)

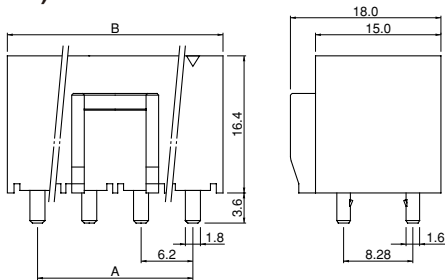

Circuits	Model No.	Dimensions (mm)		Q'ty / box
		A	B	
2	<b>B02P-VL</b>	6.2	13.4	100
3	<b>B03P-VL</b>	12.4	19.6	100
4	<b>B04P-VL</b>	6.2	13.4	100
4(single-row)	<b>B04P-VL-VN-1.8</b>	18.6	26.2	100
6	<b>B06P-VL</b>	12.4	19.6	50
8	<b>B08P-VL</b>	18.6	26.2	50
12	<b>B12P-VL</b>	31.0	38.6	40

### Material and Finish

Post: Copper-alloy, tin-plated (reflow treatment)  
Wafer: PA 66, UL94V-0, natural (white)

### RoHS compliance

## Contact position location numbers

### <Inner-housing lock>

(2 circuits)

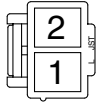

(3 circuits)



(4 circuits)

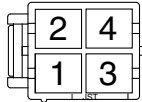

(6 circuits)

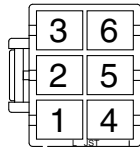

(8 circuits)

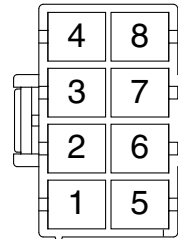

(12 circuits)

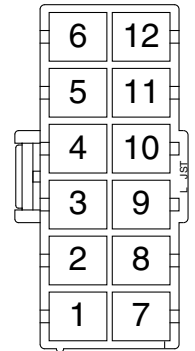

### <Outer-housing lock>

(2 circuits)

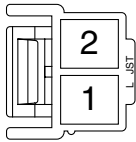

(3 circuits)

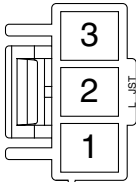

(4 circuits)

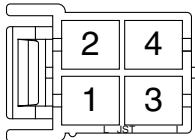

(Single-row  
4 circuits)

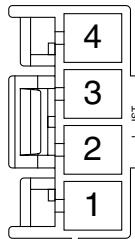

(6 circuits)

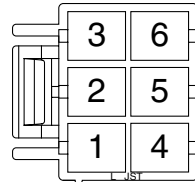

(8 circuits)

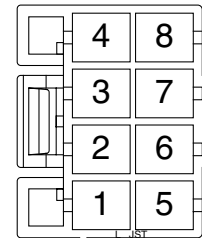

(12 circuits)

