

AS6200

Temperature Sensor

General Description

The AS6200 IC is a high accuracy temperature sensor system that communicates via a 2 wire digital bus with other devices. It consists of a Si bandgap temperature sensor, an ADC and a digital signal processor.

It has a very high temperature accuracy ($\pm 0.4^{\circ}\text{C}$ for AS6200) and an ultra-low power consumption (low operation and quiescent current) which makes it ideally suited for mobile/battery powered applications.

The AS6200 is an easy to integrate and use solution, featuring an factory calibrated sensor, integrated linearization and the possibility to use 2 different I²C addresses, enabling to use two AS6200 devices on one bus.

Additionally the AS6200 temperature sensor system also features an alert functionality, which triggers e.g. an interrupt to protect devices from excessive temperatures.

Ordering Information and Content Guide appear at end of datasheet.

Key Benefits & Features

The benefits and features of AS6200, Temperature Sensor are listed below:

Figure 1:
Added Value of Using AS6200

Benefits	Features
<ul style="list-style-type: none"> High Measurement Accuracy 	<ul style="list-style-type: none"> $\pm 0.4^{\circ}\text{C}$ (0°C to 65°C) $\pm 1^{\circ}\text{C}$ (-40°C to 125°C) (max. values)
<ul style="list-style-type: none"> Low Power Consumption 	<ul style="list-style-type: none"> 6 μA @Operation (typ. @ 4 Hz) 0.1 μA@Standby (typ.)
<ul style="list-style-type: none"> Supply Voltage Range 	<ul style="list-style-type: none"> 1.8V to 3.6 V
<ul style="list-style-type: none"> Wide Operating Temperature 	<ul style="list-style-type: none"> -40°C to 125°C
<ul style="list-style-type: none"> Small PCB Footprint 	<ul style="list-style-type: none"> 1.6 mm x 1.0 mm (WLCSP)

Applications

- HVAC and thermostat controls
- Medical instrumentation
 - Body temperature measurement
- Mobile devices
 - Thermal monitoring for smartphones, tablets and cameras
 - Smart watches and wearables
- Industrial
 - Industrial automation
 - Cold chain monitoring

Figure 2:
Typical Application Environment of the AS6200 Temperature Sensor

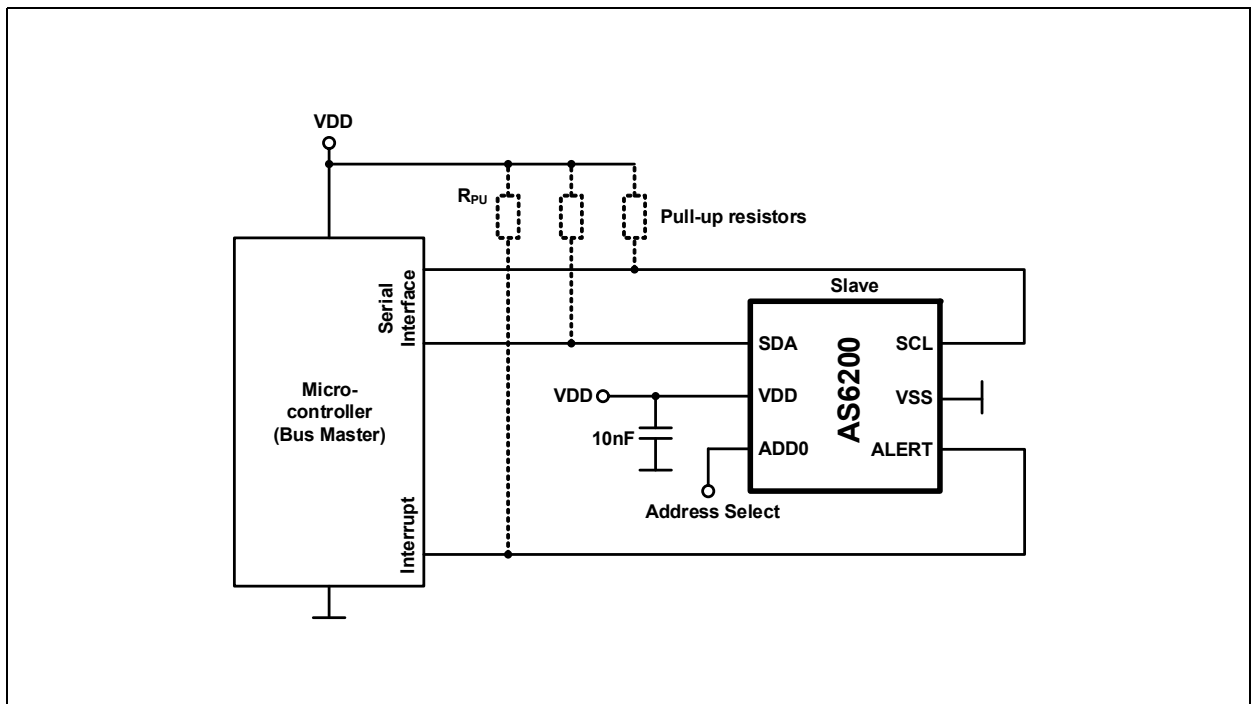

In [Figure 2](#) a typical application of the AS6200 is shown. It is connected via a serial bus (I²C) with a microcontroller.

The sensor system is also connected to the microcontroller via the “Alert” pin which can be used to trigger events in case the temperature exceeds defined limits.

Block Diagram

The functional blocks of this device are shown below:

Figure 3:
Functional Blocks of the AS6200

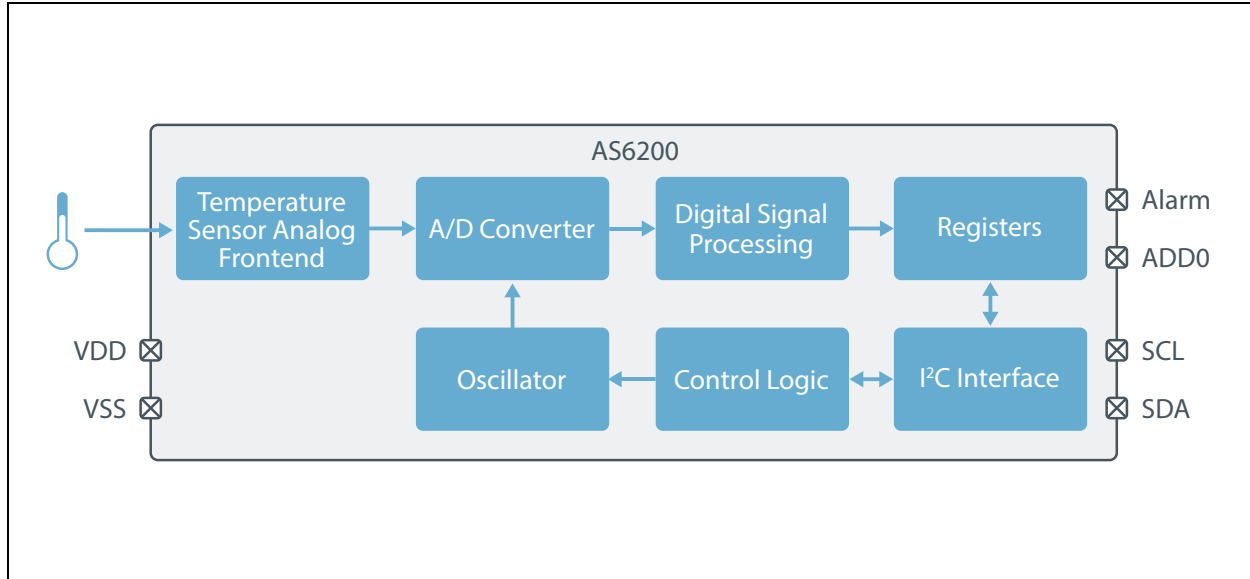

In [Figure 3](#) all relevant blocks of the AS6200 temperature sensor are shown. The sensing element is a Si bipolar transistor.

The analog signal is transformed by the A/D converter in a digital signal which is processed by the DSP and written into the registers.

The data in the register can be accessed by the serial bus (I²C).

Pin Assignments

Figure 4:
Pin Assignment WLCSP (Top View)

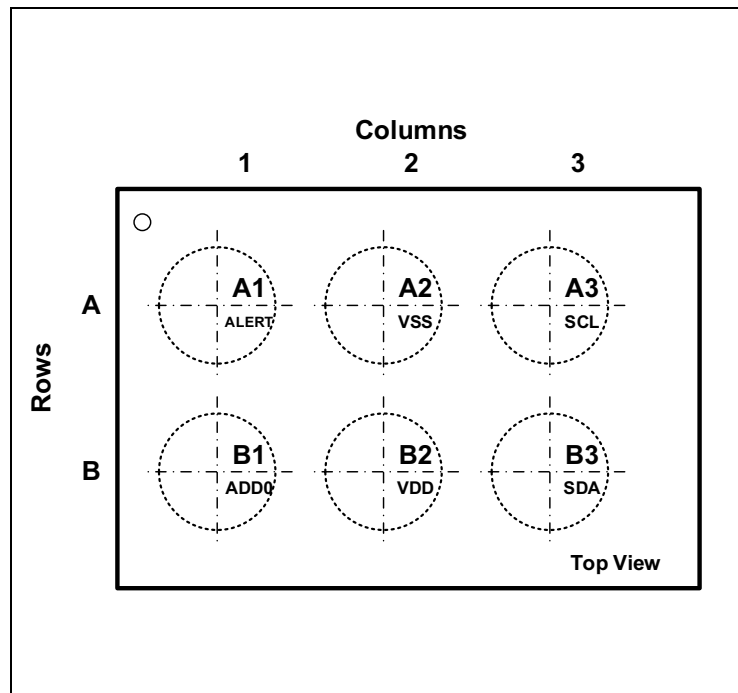

In [Figure 4](#) the pin assignment of the WLCSP package is shown. A1 pin assignment is shown via a marking on the package (top side).

Figure 5:
Pin Description

Pin number (WLCSP)	Pin Name	Description
A1	ALERT	Alert Output (interrupt)
A2	VSS	Ground Pin
A3	SCL	Serial Interface Clock
B1	ADD0	Address Select Pin
B2	VDD	Positive Supply Voltage
B3	SDA	Serial Interface Data

In [Figure 5](#) the pins of the device are described. For the pins "Alert", "SDA" and "SCL" external pull up resistors are necessary. The pin ADD0 needs to be connected and cannot be left unconnected (please refer to the bus address sections for more information).

Absolute Maximum Ratings

Stresses beyond those listed under [Absolute Maximum Ratings](#) may cause permanent damage to the device. These are stress ratings only. Functional operation of the device at these or any other conditions beyond those indicated under [Operating Conditions](#) is not implied. Exposure to absolute maximum rating conditions for extended periods may affect device reliability.

Figure 6:
Absolute Maximum Ratings

Symbol	Parameter	Min	Max	Units	Comments
Electrical Parameters					
V_{DD}/V_{SS}	Supply Voltage to Ground	-0.3	4	V	
I_{SCR}	Input Current (latch-up immunity)	-100	100	mA	JEDEC JESD78D
Electrostatic Discharge					
ESD_{HBM}	Electrostatic Discharge HBM	± 2		kV	MIL-STD-883J-3015.9
Temperature Ranges and Storage Conditions					
T_A	Operating Temperature	-40	125	°C	
T_J	Junction Temperature		150	°C	
T_{STRG}	Storage Temperature Range	-55	150	°C	
T_{BODY}	Package Body Temperature		260	°C	IPC/JEDEC J-STD-020 The reflow peak soldering temperature (body temperature) is specified according to IPC/JEDEC J-STD-020 "Moisture/Reflow Sensitivity Classification for Non-hermetic Solid State Surface Mount Devices."
RH_{NC}	Relative Humidity non-condensing	5	85	%	
MSL	Moisture Sensitivity Level	1			Maximum floor life time is unlimited

Electrical Characteristics

Operating Conditions

Figure 7:
Operating Conditions

Symbol	Parameter	Min	Typ	Max	Units	Note
VDD	DC supply voltage	1.8	3.0	3.6	V	Reference to VSS
T_AMB	Ambient temperate	-40		125	°C	

Analog System Parameters

Figure 8:
Analog System Parameters

Symbol	Parameter	Min	Typ	Max	Unit	Note
VDD	Supply voltage	1.8 2.0	3.0 3.0	3.6 3.6	V	T = 0°C to 150°C T = -40°C to 150°C
T	Temperature range	-40		125	°C	
IDD	Standby consumption		0.1 0.3	0.4 9.0	µA	T = -40°C to 65°C T = 65°C to 125°C
IDD	Current consumption (4 conversions/s)		6	7 16	µA	T = -40°C to 65°C Serial bus inactive T = 65°C to 125°C Serial bus inactive
T_ERR	Accuracy ⁽¹⁾	-0.4 -1		0.4 1	°C	T = 0°C to 65°C T = -40°C to 125°C
N	Resolution		12		Bits	Normal mode (T _{MAX} =128°C)
TS	Conversion time	24	32	40	ms	
NS	Conversion rate		0.25 1 4 8	0.35 1.35 5.5 10.7	Conv/s	CR[1:0]=00 CR[1:0]=01 CR[1:0]=10 CR[1:0]=11

Note(s):

1. The accuracy is based on measurements and reflects 4,5 σ statistics.

Detailed Descriptions

The AS6200 is a complete sensor system that has an integrated temperature sensing element, the analog frontend, the A/D converter and the digital signal processing part.

The digital signal processing part consists of the signal processor, the registers and the serial bus interface.

For block diagram please refer to [Figure 3](#).

In [Figure 8](#) an overview of the analog system parameters is given.

The current consumption with fewer conversions per second is lower than the values mentioned in [Figure 8](#).

Digital System Parameters

The device contains the following data registers as depicted in the following figure:

Figure 9:
Register Map with Serial Interface

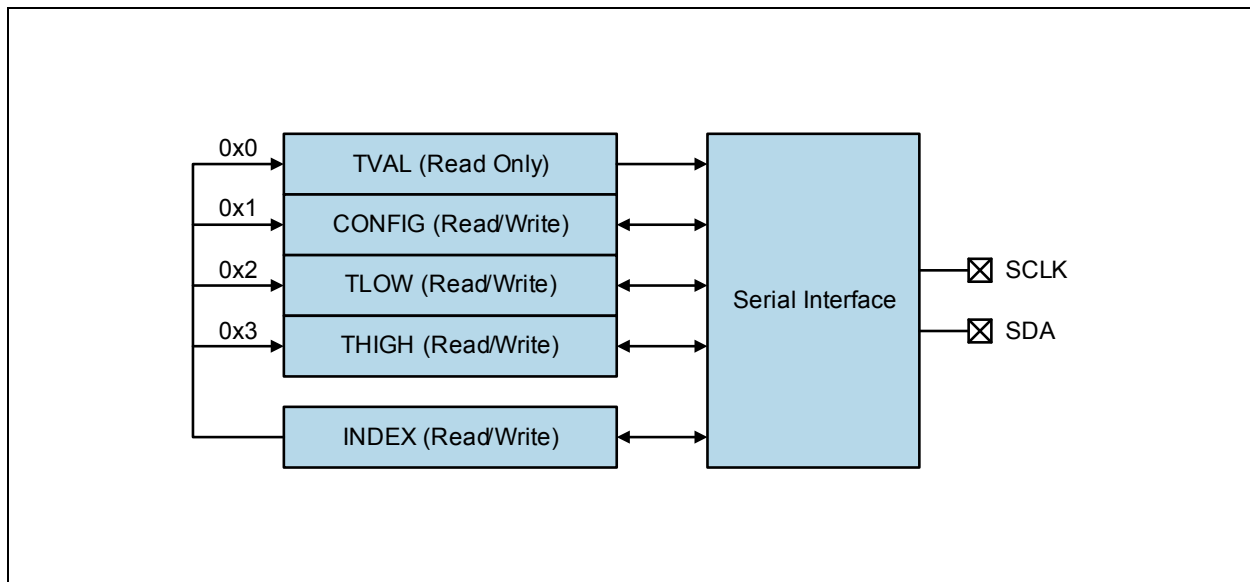

With the use of the index register, it is possible to address the specific data register. The index register is an 8 bit register, where only bits 0 and 1 are used as shown in [Figure 10](#) and all other bits are set to 0 and read only.

Figure 10:
Index Register

Bit	D7	D6	D5	D4	D3	D2	D1	D0
Value	0	0	0	0	0	0	Address Bits	

The two bit address selects the register to be accessed by the serial interface as shown in the following table.

Figure 11:
Register Map

Address	Symbol	Register	Description
0x0	TVAL	Temperature Register	Contains the temperature value
0x1	CONFIG	Configuration Register	Configuration settings of the temperature sensor
0x2	TLOW	T _{LOW} Register	Low temperature threshold value
0x3	THIGH	T _{HIGH} Register	High temperature threshold value

This means that in order to access the different registers, the index register must be set accordingly. With the exception of the TVAL register (which contains the temperature value data), all registers are read/write accessible.

Configuration Register

The configuration register is a 16-bit register which defines the operation modes of the device. Any read/write operations processes the MSB byte first.

Figure 12:
Configuration Register

Bit	D15	D14	D13	D12	D11	D10	D9	D8	D7	D6	D5	D4	D3	D2	D1	D0
R/W	RW	RO		RW							RO	RW	RO			
Bit	SS	Reserved		CF		POL	IM	SM	CR		AL	Reserved				
Default	0	1	0	0	0	0	0	0	1	0	1	0	0	0	0	0
	MSB Byte								LSB Byte							

In [Figure 12](#) the configuration register is shown. The bits D0-4 and D13-14 are not to be used and are set to read only. The explanation of the other bits are detailed in the following sections

Data Width, Bit D4

For AS6200 only the 12 bit mode is supported by the device, which means that the DW should always be set to 0.

Alert, Bit D5

The alert bit can be used to easily compare the current temperature reading to the thresholds that can be set in the TLOW and THIGH registers.

If the polarity bit is set to 0, the AL bit is read as 1 until the converted temperature value exceeds the defined value in the high temperature threshold register THIGH for the number of defined consecutive faults (bits CF). Such an event causes the AL bit to toggle to 0 and the value is kept until the converted temperature value falls below the defined value in the low temperature threshold register TLOW for the number of defined consecutive faults. If this condition is met, the AL bit is reset to 1.

The polarity bit (POL) defines the active state of the alert bit as depicted in the following figure.

The alert bit has the same setting as the alert output as long as the device is configured for the comparator mode.

Figure 13:
State Diagram of the Alert Bit

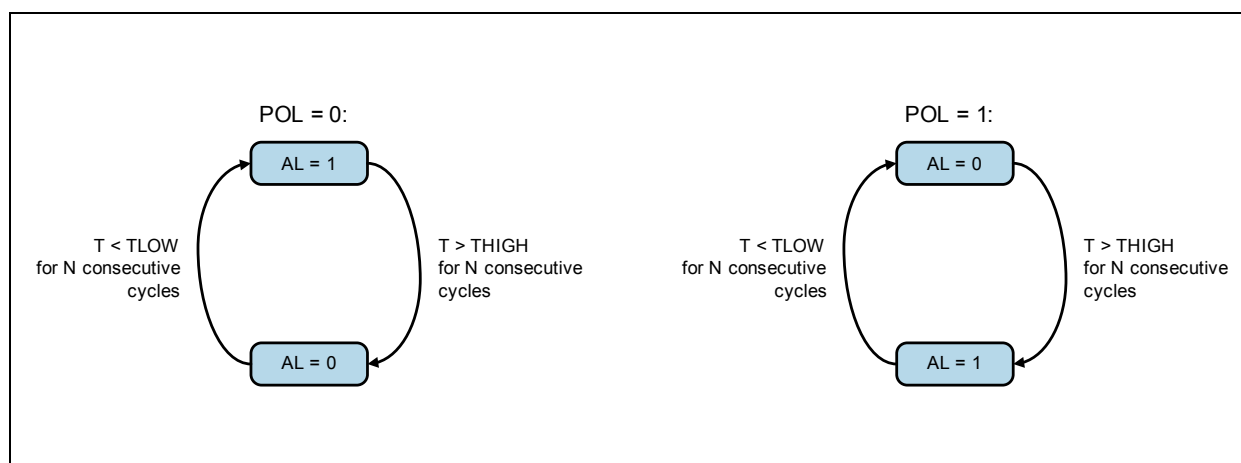
**Conversion Rate, Bit D6-D7**

The conversion rate bits define the number of executed temperature conversions per time unit. Additional readouts of the temperature register between conversion is possible but not recommended because the value is changed only after a conversion is finished.

Values of 125ms, 250ms, 1s and 4s per conversion can be configured while the default rate is set to 250ms. This corresponds to a value of 4 conversions per second.

The following table summarizes the different configuration settings:

Figure 14:
Conversion Rate Configuration

CR Bits		Conversion Rate	Conversion Frequency
D7	D6		
0	0	4s	0.25Hz
0	1	1s	1Hz
1	0	250ms	4Hz (default value)
1	1	125ms	8Hz

The device immediately starts a conversion after a power-on sequence and provides the first result after typ. 32ms (max. 40ms). A higher power consumption occurs during the actual conversion while the device stays in the standby mode after a finished conversion until the next conversion is activated as shown in the following figure.

Figure 15:
Conversion Sequence

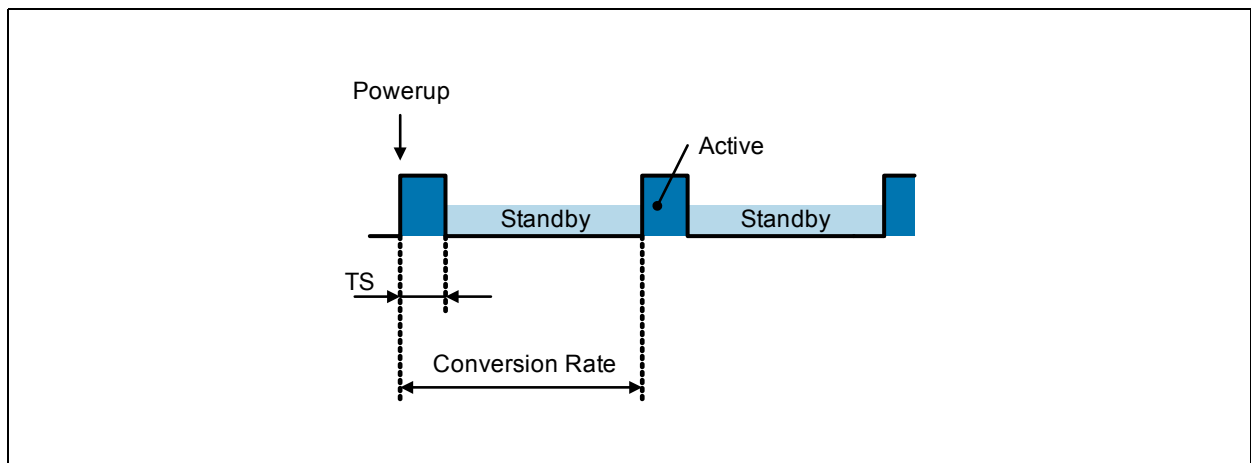

Sleep Mode, Bit D8

The sleep mode is activated by setting the bit SM in the configuration register to 1. This shuts the device down immediately and reduces the power consumption to a minimum value.

The serial interface is the only active circuitry in the sleep mode in order to provide access to the digital registers.

After resetting the SM bit to 0, the device enters the continuous conversion mode.

Figure 16:
Sleep Mode Configuration

SM Bit	Operation Mode
0	Continuous Conversion Mode
1	Sleep Mode

Interrupt Mode, Bit D9

The interrupt mode bit defines whether the device operates in the temperature comparator mode or interrupt mode. This defines the operation mode of the ALERT output as described in the polarity bit section.

Figure 17:
Interrupt Mode Configuration

IM Bit	Operation Mode
0	Comparator Mode
1	Interrupt Mode

The comparator mode is characterized that if the temperature value exceeds the THIGH value, the alert output is changed (e.g. from high to low if the polarity bit is set to 0 and vice versa). The alert output stays in that condition until the measured temperature drops below the defined TLOW value.

The interrupt mode is characterized that it changes the alert output as soon as the measured temperature crosses the THIGH or TLOW value threshold.

The alert bit has the same setting as the alert output if the device is set to comparator mode.

Figure 18:
ALERT Output Functionality

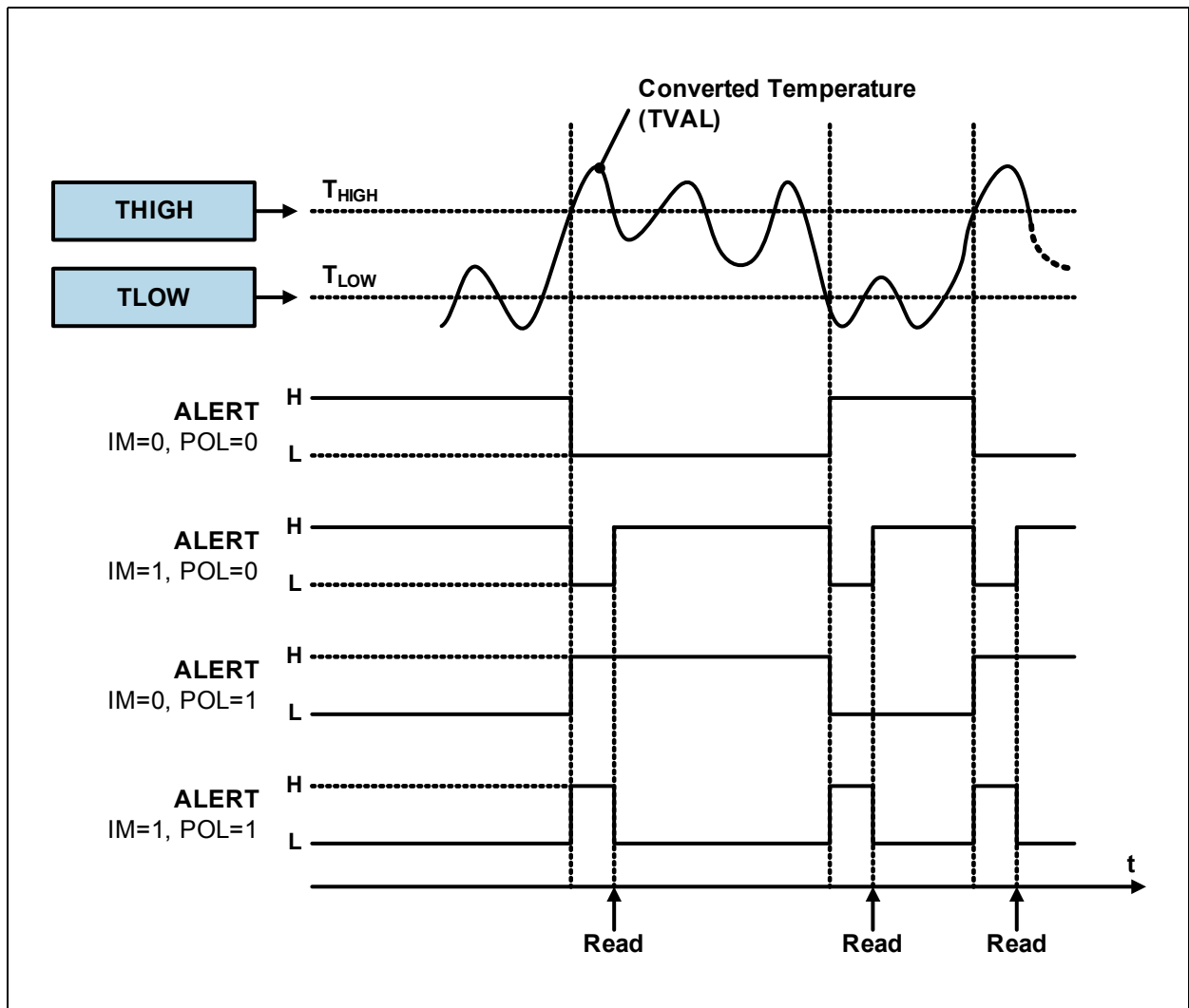

Polarity, Bit D10

The polarity bit configures the polarity of the ALERT output. If the polarity bit is cleared, the ALERT output is low active while it becomes high active if the polarity bit is set to '1'.

Figure 19:
Polarity Bit Configuration

POL Bit	ALERT Output
0	Active low
1	Active high

Consecutive Faults, Bits D11-D12

A fault condition persists if the measured temperature either exceeds the configured value in register THIGH or falls below the defined value in register TLOW. As a result, the ALERT pin indicates the fault condition if a defined number of consecutive temperature readings meets this fault condition. The number of consecutive faults are defined with two bits (D12 and D11) and prevent a false alert if environmental temperature noise is present. The register configuration is shown in the following table.

Figure 20:
Consecutive Faults Bit Settings

CF Bits		Consecutive Faults (N)
D12	D11	
0	0	1
0	1	2
1	0	4
1	1	6

Single Shot Conversion, Bit D15

The device features a single shot measurement mode if the device is in sleep mode (SM=1). By setting the “Single Shot-bit” to 1, a single temperature conversion is started and the SS-bit can be read as 1 during the active conversion operation. Once the conversion is completed, the device enters the sleep mode again and the SS-bit is set to 0. The single shot conversion allows very low power consumption since a temperature conversion is executed on demand only. This allows a user defined timing of the temperature conversions to be executed and is used if the consecutive operation mode is not required.

As the device exhibits a very short conversion time, the effective conversion rate can be increased by setting the single shot bit repetitively after a conversion has finished. However, it has to be ensured that the additional power is limited, otherwise self-heating effects have to be considered.

Figure 21:
Single Shot Conversion Bit Settings

SS Bit	Conversion
0	No conversion ongoing/conversion finished
1	Start Single Shot conversion /conversion ongoing

High- and Low-Limit Registers

If the comparator mode is configured (IM=0), the ALERT output becomes active if the temperature equals or exceeds the defined value in register THIGH for the configured number of consecutive faults (N). This configuration is defined by the field CF in the configuration register. The ALERT output remains assigned until the converted temperature value equals or falls below the defined value in register TLOW for the same number of consecutive fault cycles.

If the interrupt mode is configured (IM=1), the ALERT output becomes active if the temperature equals or exceeds the defined value in register THIGH for the configured number of consecutive fault cycles. It remains active until a read operation is executed on any register. The ALERT output is also cleared if the device is set into sleep mode by setting bit SM in the configuration register.

Once the ALERT output is cleared, it is activated again only if the temperature value falls below the configured value in register TLOW. It remains active unless a read operation has taken place.

This sequence is repeated unless the device is set into the comparator mode or reset by the General Call Reset command. This reset command clears the interrupt mode bit and consequently puts the device into the comparator mode.

The sequential behavior is summarized in the following figure.

Figure 22:
ALERT Operation Modes

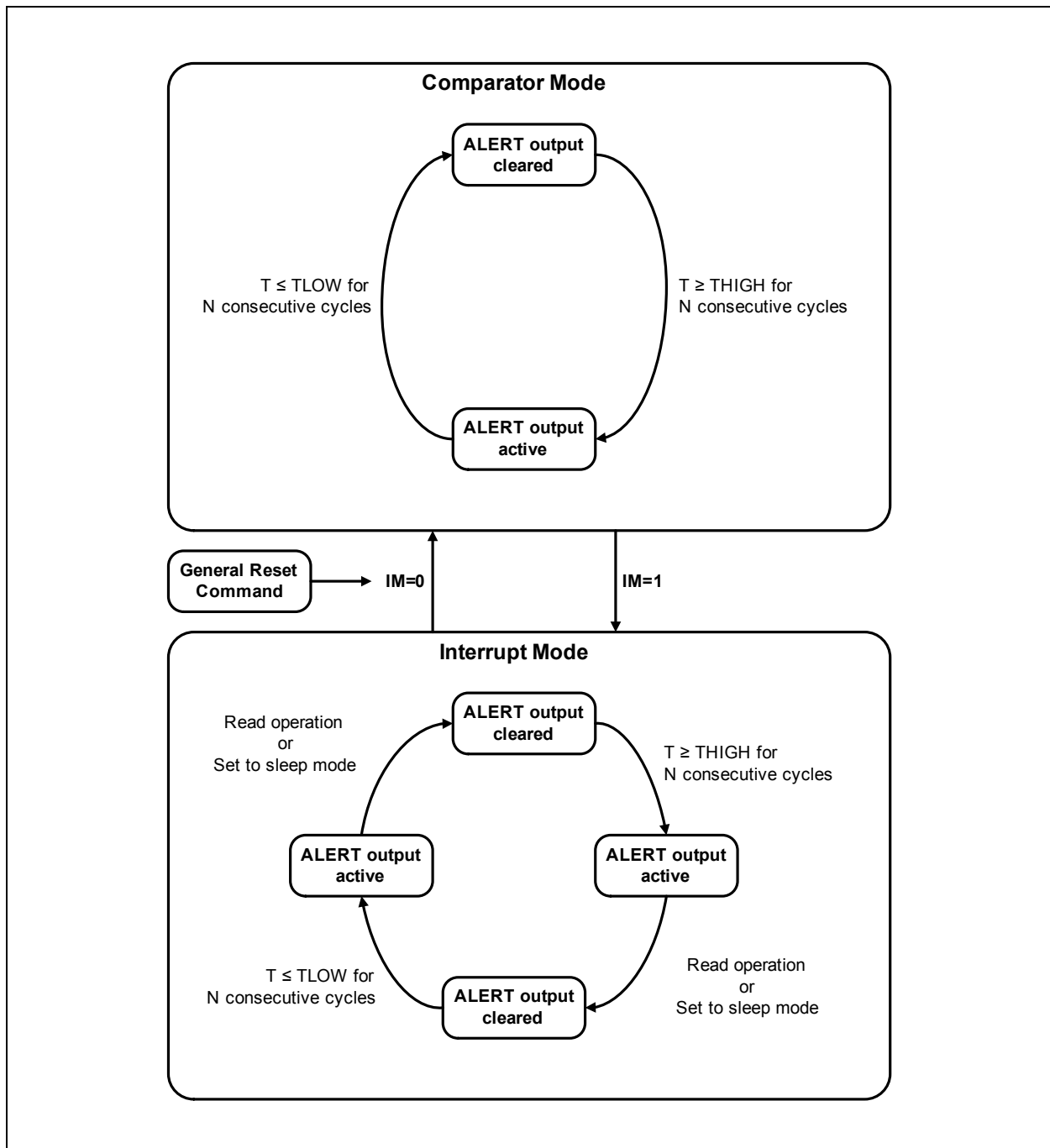

The following table defines the content of the registers TLOW and THIGH. For data transmission, the MSB byte is transmitted first, followed by the LSB byte. The data format for representing the threshold temperatures is equal to the temperature register (TVAL). After a powerup, the registers are initialized with the following default values:

Figure 23:
Default Values for THIGH and TLOW

Register	Temperature	Binary Value (12 Bit)
TLOW	75°C	L11..L0 = 0100 1011 0000
THIGH	80°C	H11..H0 = 0101 0000 0000

The following table defines the register bits of the THIGH and TLOW register.

Figure 24:
Register Bit Settings for THIGH/TLOW

D15	D14	D13	D12	D11	D10	D9	D8	D7	D6	D5	D4	D3	D2	D1	D0
H11	H10	H9	H8	H7	H6	H5	H4	H3	H2	H1	H0	0	0	0	0
MSB Byte								LSB Byte							

Temperature Register

The temperature register contains the digitally converted temperature value and can be read by setting the index pointer to the TVAL register (0x0).

Figure 25:
Temperature Value Register

D15	D14	D13	D12	D11	D10	D9	D8	D7	D6	D5	D4	D3	D2	D1	D0
T11	T10	T9	T8	T7	T6	T5	T4	T3	T2	T1	T0	0	0	0	0
MSB Byte								LSB Byte							

Two consecutive bytes must be read to obtain the complete temperature value. The MSB byte (Bits D15...D8) is transmitted upon the first read access and the LSB byte (Bits D7...D0) is transmitted after the second read access. The least significant bits D3...D0 are set to 0.

A temperature value is represented as a two complement value in order to cover also negative values. After powerup, the temperature value is read as 0°C until the first conversion has been completed. One LSB corresponds to 0.0625°C.

The binary values can be calculated according to the following formulas:

Positive values: $|\text{Value}| / \text{LSB}$

Negative values: $\text{Complement}(|\text{Value}| / \text{LSB}) + 1$

Example 75°C:

$75^\circ\text{C} / 0.0625^\circ\text{C} = 1200 = \text{Binary } 0100\ 1011\ 0000 = \text{Hex } 4B0$

Example -40°C:

$\overline{|-40^\circ\text{C}|} / 0.0625^\circ\text{C} + 1 = \overline{640} + 1 = \text{Binary } \overline{0010\ 1000\ 0000} + 1 = 1101\ 0111\ 1111 + 1 = 1101\ 1000\ 0000 = \text{Hex } D80$

Figure 26:
Temperature Conversion Examples

Temperature (°C)	Digital Output (Binary)	Digital Output (Hex)
100.0	0110 0100 0000	640
75.0	0100 1011 0000	4B0
50.0	0011 0010 0000	320
25.0	0001 1001 0000	190
0.125	0000 0000 0010	002
0.0625	0000 0000 0001	001
0.0	0000 0000 0000	000
-0.0625	1111 1111 1111	FFF
-0.125	1111 1111 1110	FFE
-25.0	1110 0111 0000	E70
-40.0	1101 1000 0000	D80

Serial Interface

The device employs a standard I²C-Interface.

Bus Description

A data transfer must be invoked by a master device (e.g. microcontroller) which defines the access to the slave device. The master device defines and generates the serial clock (SCL) and the start/stop conditions.

In order to address a specific device, a START condition has to be generated by the master device by pulling the data line (SDA) from a logic high level to a logic low level while the serial clock signal (SCL) is kept at high level.

After the start condition, the slave address byte is transmitted which is completed with a ninth bit which indicates a read (bit='1') or a write operation (bit='0') respectively. All slaves read the data on the rising edge of the clock. An acknowledge signal is generated by the addressed slave during the ninth clock pulse. This acknowledge signal is produced by pulling the pin SDA to a low level by the selected slave.

Subsequently, the byte data transfer is started and finished by an acknowledge bit. A change in the data signal (SDA) while the clock signal (SCL) is high causes a START or STOP condition. Hence, it must be ensured such a condition is prevented during a data transfer phase.

After completing the data transfer, the master generates a STOP condition by pulling the data line (SDA) from low level to high level while the clock signal (SCL) is kept at high level.

Data Interface

A bus connection is created by connecting the open drain input/output lines SDA and SCL to the two wire bus. The inputs of SDA and SCL feature Schmitt-trigger inputs as well as low pass filters in order to suppress noise on the bus line. This improves the robustness against spikes on the two wire interface.

Both fast transmission mode (1 kHz to 400 kHz) and high-speed transmission mode (1 kHz to 3.4 MHz) are employed to cover different bus speed settings.

Any data transfer transmits the MSB first and the LSB as last bit.

Bus Address

A slave address consists of seven bits, followed by a data direction bit (read/write operation). The slave address can be selected from a pool of two different address settings by connecting the input pin ADD0 to an appropriate signal as summarized in the following table.

The ADD0 must not be left unconnected.

Figure 27:
I²C Address Select Configuration

ADD0 Connection	Device Address (bin)	Device Address (hex)
VSS	100 1000	0x48
VDD	100 1001	0x49

Read/Write Operation

In order to access an internal data register, the index register must be written in advance. This register contains the actual register address and selects the appropriate register for an access. A typical transfer consists of the transmission of the slave address with a write operation indication, followed by the transmission of the register address and is finalized with the actual register content data transfer. This implies that every write operation to the temperature sensor device requires a value for the index register prior to the transmission of the actual register data.

The index register defines the register address for both the write and read operation. Consequently, if a read operation is executed, the register address is taken from the index register which was defined from the last write operation.

If a different register needs to be read, the index register has to be written in advance to define the new register address. This is accomplished by transmitting the slave address with a low R/W bit, followed by the new content of the index register. Subsequently, the master provokes a START condition on the bus and transmits the slave address with a high R/W bit in order to initiate a read operation.

Since the index register always keeps its last value, reads can be executed repetitively on the same register.

Similarly to the byte transfer where the MSB is transmitted first, the transfer of a 16-bit word is executed by a two byte transfer whereas the MSB byte is always transmitted first.

Slave Operation

The device employs a slave functionality only (slave transmitter and slave receiver) and cannot be operated as a bus master. Consequently, the device never actively drives the SCL line.

Slave Receiver Mode

Any transmission is invoked by the master device by transmitting the slave address with a low R/W bit. Subsequently, the slave device acknowledges the reception of the valid address by pulling the ninth bit to a low level. Following to acknowledge, the master transmits the content of the index register. This transfer is again acknowledged by the slave device. The next data byte(s) are written to the actual data register which is selected by the index register while each transfer is acknowledged upon a completed transfer by the slave device. A data transfer can be finished if the master transmits a START or a STOP condition on the bus.

Slave Transmitter Mode

The master transmits the slave address with a high R/W bit. In turn, the slave acknowledges a valid slave address. Subsequently, the slave transmits the MSB byte of the actual selected data register by the index register. After the MSB byte transmission, acknowledge is sent by the master. Afterwards, the LSB byte is transmitted by the slave which is also acknowledged by the master after the completed transmission. The data transfer can be terminated by the master by transmitting a Not-Acknowledge after the transmitted slave data or by invoking a START or a STOP condition on the bus.

Alert Function

If the device is configured for an interrupt mode operation (IM=1), the ALERT output can be used as an alert signal.

If the polarity bit is set to '0' (POL='0'), the alert condition bit is set to '0' in case the temperature has exceeded the configured value in register THIGH. Accordingly, the alert condition bit is set to '1' if the temperature has fallen below the configured value in register TLOW.

If the polarity bit is set to '1' (POL='1'), the alert condition bit is inverted. The following table summarizes the status of the alert condition bit with different alert conditions and polarity configurations.

Figure 28:
Alert Condition Bit

POL	Alert Condition	Alert Condition Bit (AC-Bit)
0	$T \geq \text{THIGH}$	0
0	$T \leq \text{TLOW}$	1
1	$T \geq \text{THIGH}$	1
1	$T \leq \text{TLOW}$	0

General Call

A general call is issued by the master by transmitting the general call address (000 0000) with a low R/W bit. The slave device acknowledges the general call address and responds to commands in the second byte. If the master transmits a value of 0000 0110 as a second byte, the device is reset and all registers are initialized with their default values.

In contrast to the General Call Address, the General Address Acquire command is not supported.

High Speed Mode

The bus operation is limited to 400kHz unless a high speed command is issued by the master device as the first byte after a START condition. This switches the bus to a high speed operation which allows data transfer frequencies up to 3.4MHz. Such a command is not acknowledged by the slave but the input filter time constants on the serial interface (SDA and SCL) are adapted to allow the higher transfer rate.

After a high speed command, the slave address is transmitted by the master in order to invoke a data transfer. The bus keeps operating at the higher operating frequency until the master issues a STOP condition on the serial bus. Upon the reception of the STOP condition by the slave, the input filters are switched to their initial time constants which allow lower transfer rates only.

Summary of Bus Commands

Figure 29:
Summary of Bus Commands

Command	Address	Data Value
General Call Address	000 0000	
Device initialization		0000 0110
General Address Acquire	Not supported	
High Speed Command		0000 1xxx

Timeout Function

The serial interface of the slave device is reset if the clock signal SCL is kept low for typ. 30ms. Such a condition results in a release of the data line by the slave in case it has been pulled to low level. The slave remains inactive after a timeout and waits for a new START command invoked by the bus master. In order to prevent a timeout, the bus transfer rate must be higher than 1kHz.

Bus Conditions

The following conditions occur on the serial bus which is compatible to the I²C-Bus.

- **Bus Idle:** The signals SDA and SCL are not actively driven and pulled to a high level by an external pull-up resistor.
- **Start Data Transfer:** A transition of the SDA input from high to low level while the SCL signal is kept at high level results in a START condition. Such a START condition must precede any data transfer.
- **Stop Data Transfer:** A transition of the SDA input from low to high level while the SCL signal is kept at high level results in a STOP condition. Any data transfer is finished by generating a STOP or START condition.
- **Data Transfer:** The master device defines the number of data bytes between a START and STOP condition and there is no limitation in the amount of data to be transmitted. If it is desired to read only a single MSB byte without the LSB byte, a termination of the data transfer can be provoked by issuing a START or STOP condition on the bus.
- **Acknowledge:** It is mandatory for each slave device to respond with acknowledge if the device is addressed by the master. Acknowledge is indicated by pulling down the data line (SDA) while the clock signal (SCL) is high in the acknowledge clock phase. In order to avoid an unwanted START or STOP condition on the bus, setup and hold times must be met.

The master can signal an end of data transmission by transmitting a Not-Acknowledge on the last transmitted data byte by keeping the acknowledge bit at high level.

Timing Characteristics

Figure 30:
Serial Interface Timing Diagram

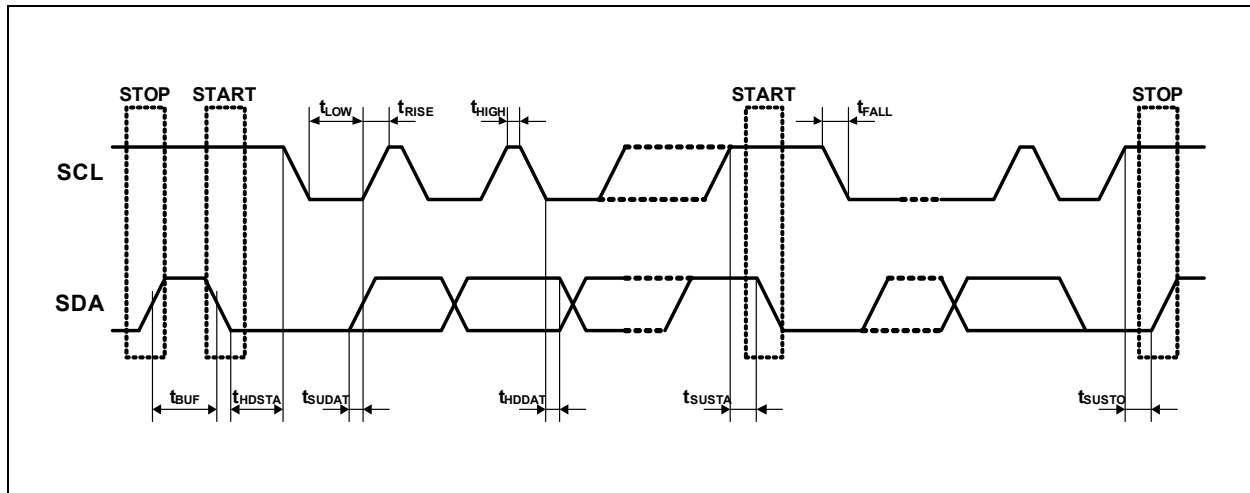

Figure 31:
Bus Timing Specifications

Parameter	Symbol	Fast Mode		High Speed Mode		Unit
		Min	Max	Min	Max	
SCL Clock Frequency	f_{SCL}	0.001	0.4	0.001	3.4	MHz
Bus free time between STOP and START condition	t_{BUF}	600		160		ns
Hold time after repeated START condition	t_{HDSTA}	100		100		ns
Repeated START condition setup time	t_{SUSTA}	100		100		ns
Data in hold time	t_{HDDAT}	10		10		ns
Data out hold time ⁽¹⁾	t_{DH}	100		100		ns
Data setup time	t_{SUDAT}	100		10		ns
SCL clock low period	t_{LOW}	1300		160		ns
SCL clock high period	t_{HIGH}	600		60		ns
Clock/Data fall time	t_F		300		160	ns
Clock/Data rise time	t_R		300		160	ns
Clock/Data rise time for $SCL \leq 100kHz$	t_R		1000		-	ns

Note(s):

1. The device will hold the SDA line high for 100 ns during the falling edge of the SCL.

Timing Diagrams

The following timing diagrams depict the different bus operation modes and data transmission.

Figure 32:
Timing Diagram for Word Write

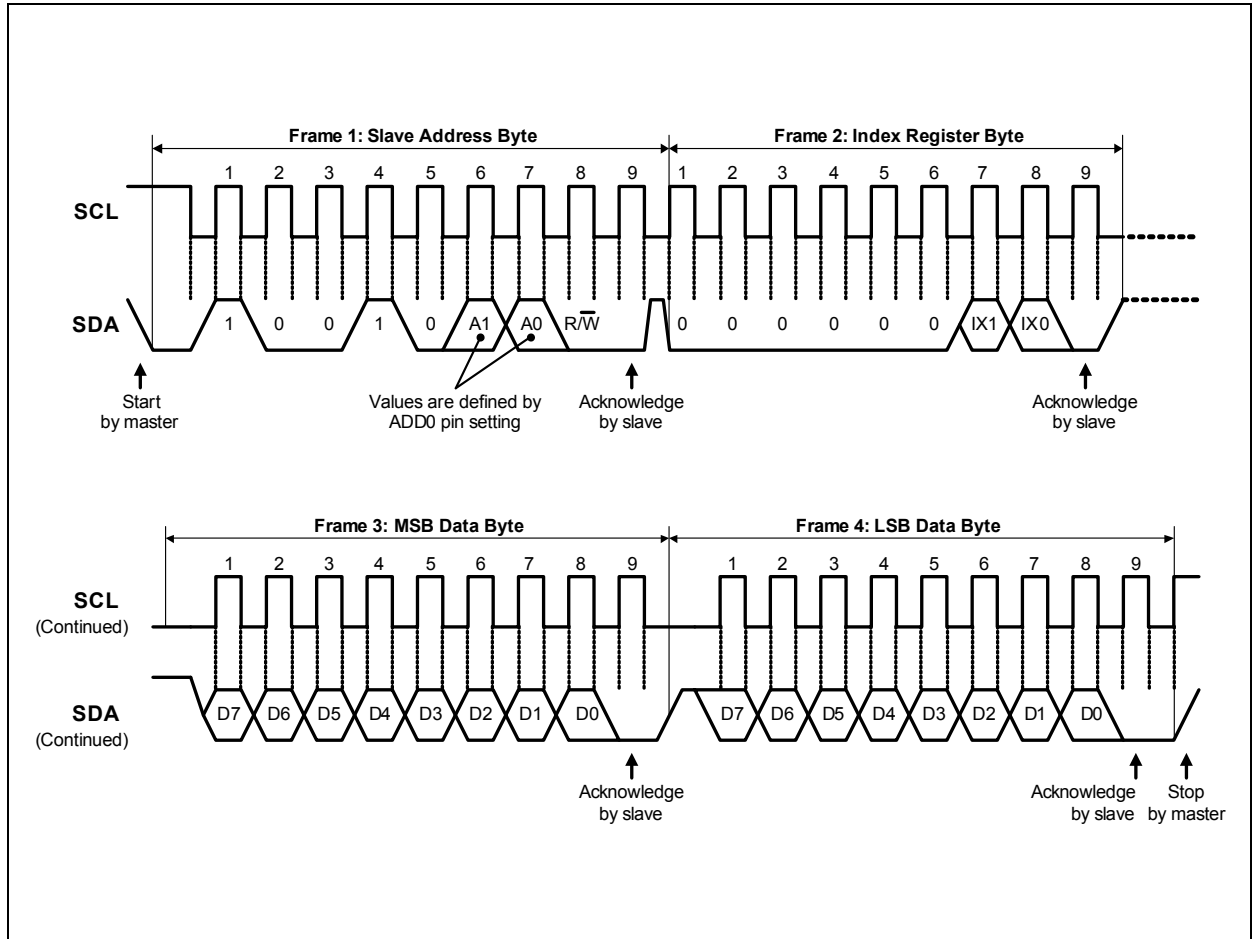
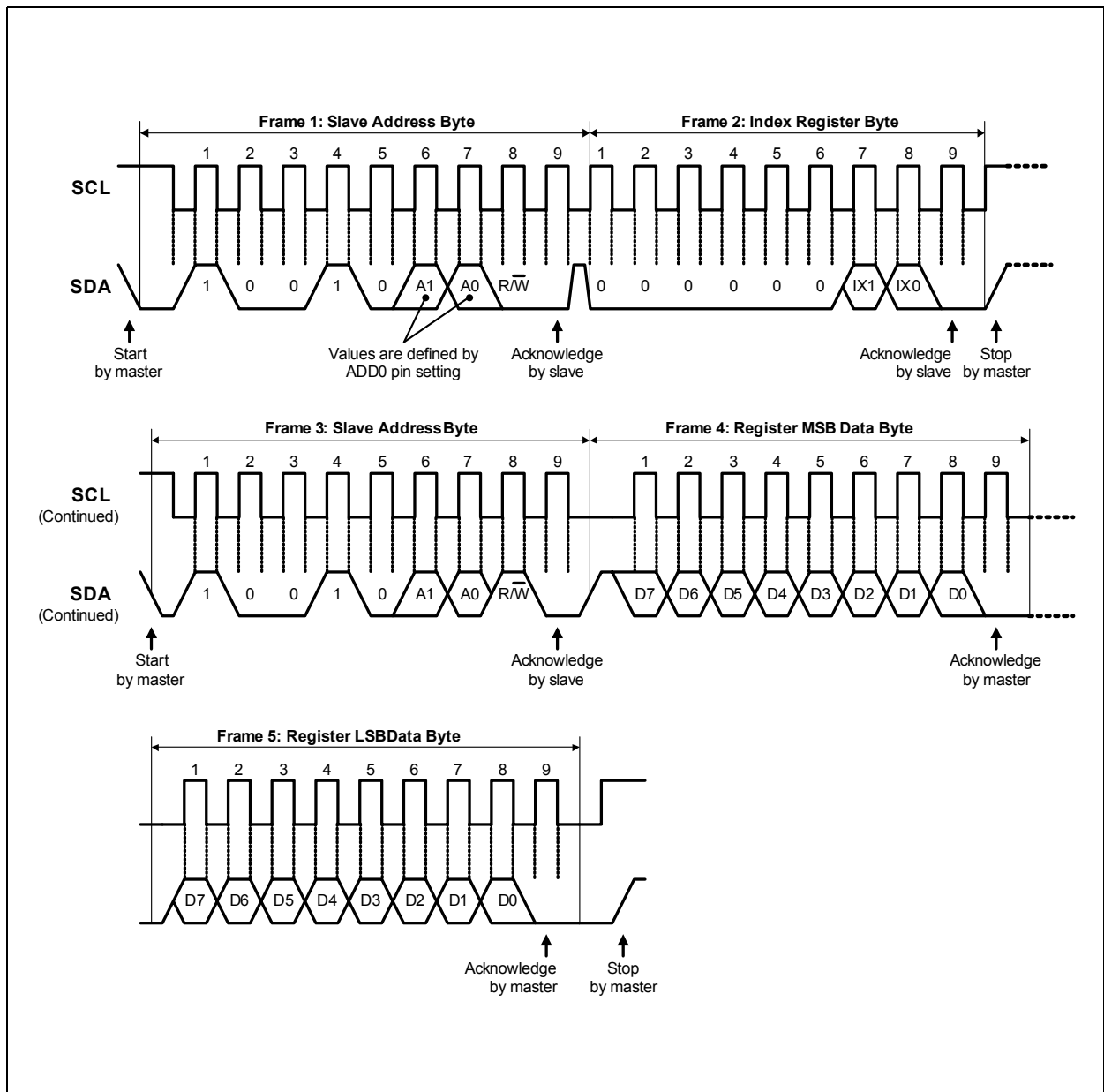
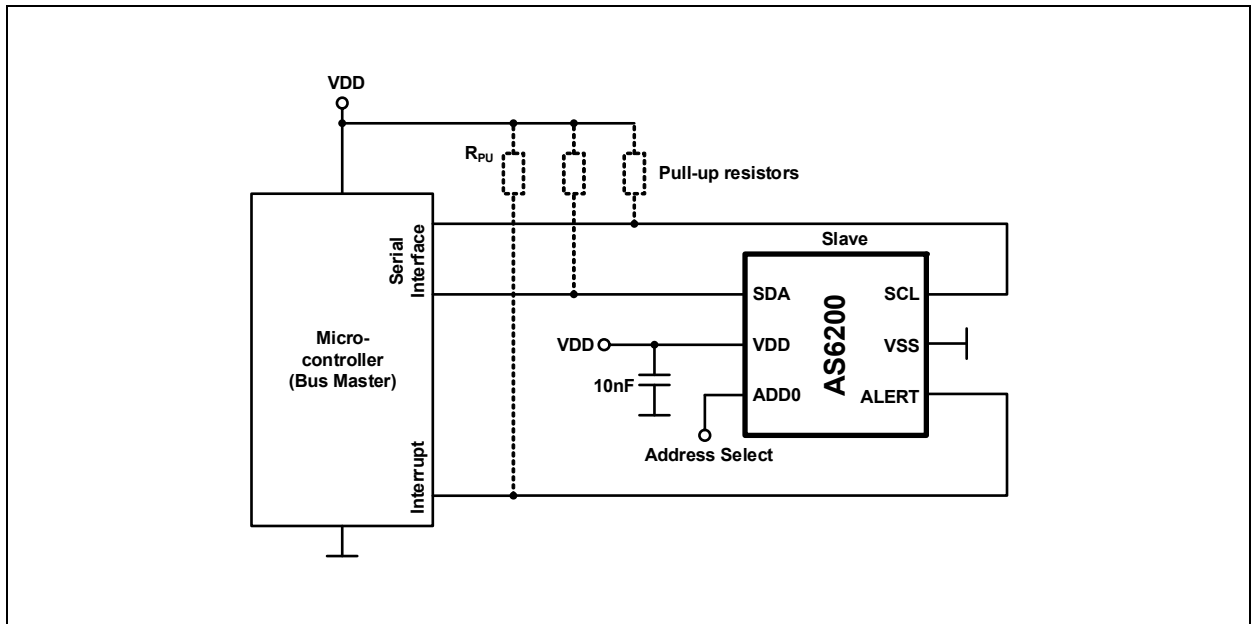

Figure 33:
Timing Diagram for Word Read



Application Information

Figure 34:
Typical Application for the AS6200 Temperature Sensor



In [Figure 34](#) the connections of the AS6200 temperature sensors to a microcontroller and the supply voltage are shown.

The AS6200 is connected to a microcontroller via an I²C bus (SDA and SCL only). Additionally the Alert output can also be used for temperature monitoring (e.g. using the interrupt mode, refer to IM bit settings), an example is given in [Figure 34](#) where the Alert output is connected to a microcontroller.

The I²C of the AS6200 address of the can be selected by connecting the ADD0 pin to VDD or VSS (refer to [Figure 27](#)). This pin must not be left unconnected.

External Components

Figure 35:
Schematic with External Components

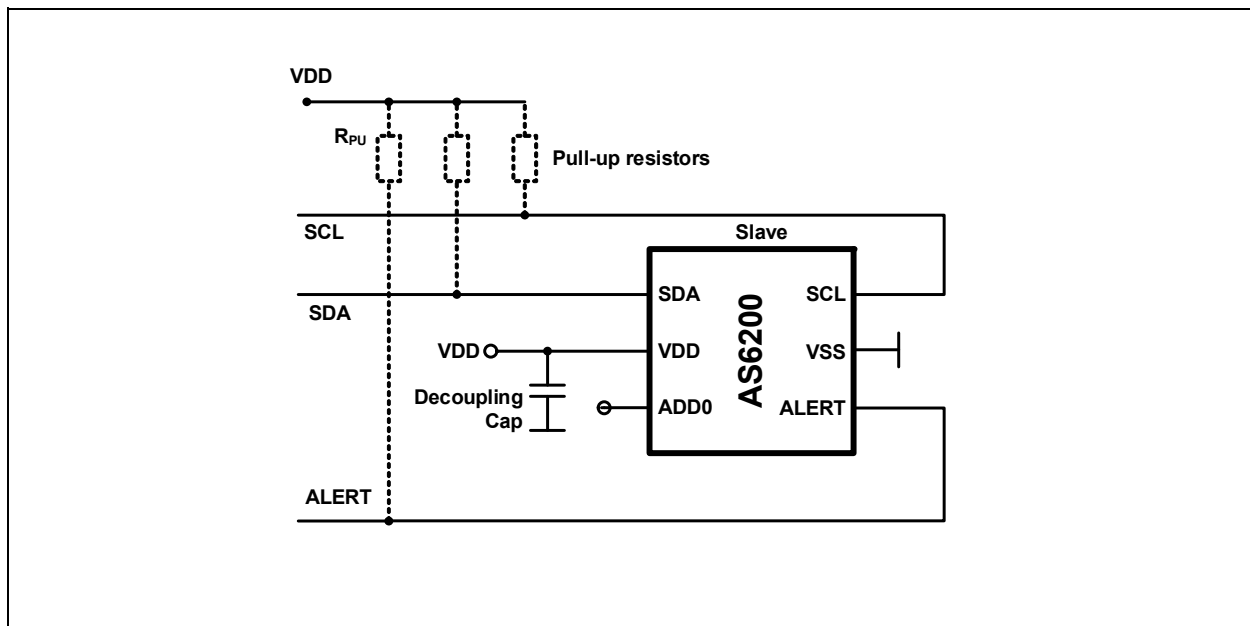

Figure 36:
Values for External Components

Parameter	Min	Max	Unit
Decoupling capacitor	10		nF
Pull-up resistors	10	18	kΩ

In [Figure 35](#) and [Figure 36](#) the schematics for external components are shown.

The decoupling capacitor for the supply should have a value of at least 10 nF.

The pull-up resistors on the serial interface and the interrupt also depend on the bus capacitance and on the clock speed, in [Figure 36](#) recommended values are given.

Package Drawings & Markings

Figure 37:
Mechanical Dimensions of the WLCSP Package

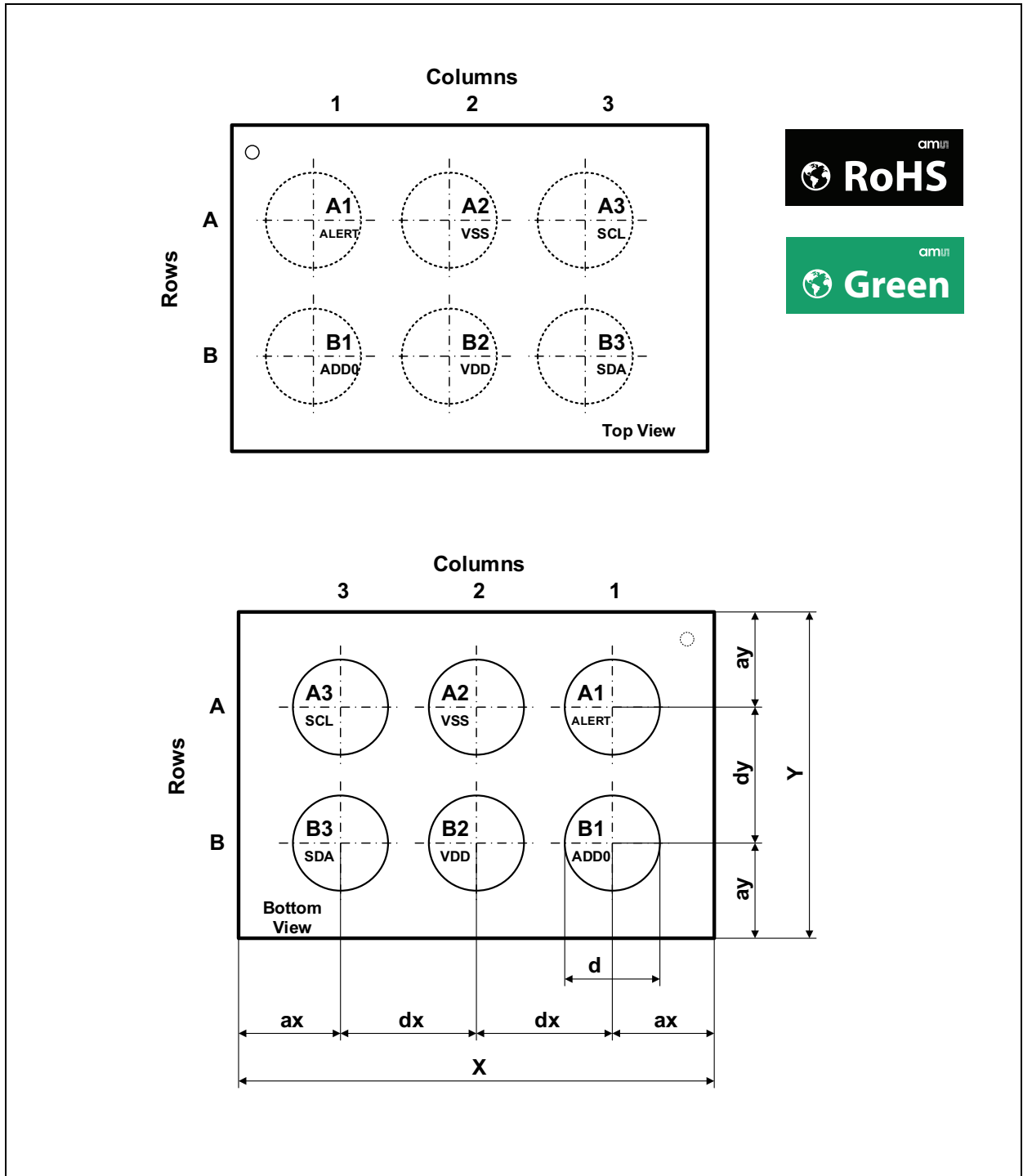

Figure 38:
Mechanical Specifications of WLCSP Package

Symbol ⁽¹⁾	Dimension [µm]		
	Min	Typ	Max
X	1450		1530
Y	960		1040
ax		325	
dx		400	
ay		280	
dy		400	
d		250	
Thickness (w.o. balls)		378	

Note(s):

1. As used in [Figure 37](#)

Figure 39:
Marking of WLCSP Package (Top View)

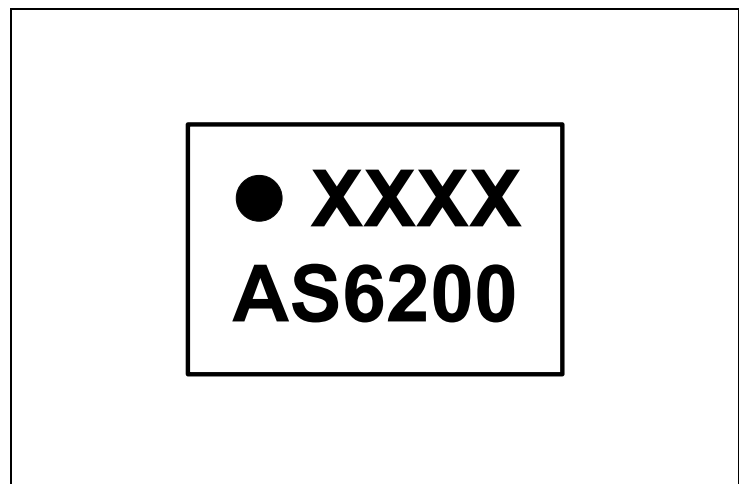

Figure 40:
Package Code

XXXX
Tracecode

Ordering & Contact Information

Figure 41:
Ordering Information

Ordering Code	Package	Marking	Delivery Form	Delivery Quantity
AS6200-AWLT-S	WLCSP	AS6200	7" Tape and Reel in dry pack	500 pcs/reel
AS6200-AWLT-L	WLCSP	AS6200	13" Tape and Reel in dry pack	5000 pcs/reel

Buy our products or get free samples online at:

www.ams.com/ICdirect

Technical Support is available at:

www.ams.com/Technical-Support

Provide feedback about this document at:

www.ams.com/Document-Feedback

For further information and requests, e-mail us at:

ams_sales@ams.com

For sales offices, distributors and representatives, please visit:

www.ams.com/contact

Headquarters

ams AG

Tobelbaderstrasse 30

8141 Premstaetten

Austria, Europe

Tel: +43 (0) 3136 500 0

Website: www.ams.com

RoHS Compliant & ams Green Statement

RoHS: The term RoHS compliant means that ams AG products fully comply with current RoHS directives. Our semiconductor products do not contain any chemicals for all 6 substance categories, including the requirement that lead not exceed 0.1% by weight in homogeneous materials. Where designed to be soldered at high temperatures, RoHS compliant products are suitable for use in specified lead-free processes.

ams Green (RoHS compliant and no Sb/Br): ams Green defines that in addition to RoHS compliance, our products are free of Bromine (Br) and Antimony (Sb) based flame retardants (Br or Sb do not exceed 0.1% by weight in homogeneous material).

Important Information: The information provided in this statement represents ams AG knowledge and belief as of the date that it is provided. ams AG bases its knowledge and belief on information provided by third parties, and makes no representation or warranty as to the accuracy of such information. Efforts are underway to better integrate information from third parties. ams AG has taken and continues to take reasonable steps to provide representative and accurate information but may not have conducted destructive testing or chemical analysis on incoming materials and chemicals. ams AG and ams AG suppliers consider certain information to be proprietary, and thus CAS numbers and other limited information may not be available for release.

Copyrights & Disclaimer

Copyright ams AG, Tobelbader Strasse 30, 8141 Premstaetten, Austria-Europe. Trademarks Registered. All rights reserved. The material herein may not be reproduced, adapted, merged, translated, stored, or used without the prior written consent of the copyright owner.

Devices sold by ams AG are covered by the warranty and patent indemnification provisions appearing in its General Terms of Trade. ams AG makes no warranty, express, statutory, implied, or by description regarding the information set forth herein. ams AG reserves the right to change specifications and prices at any time and without notice. Therefore, prior to designing this product into a system, it is necessary to check with ams AG for current information. This product is intended for use in commercial applications. Applications requiring extended temperature range, unusual environmental requirements, or high reliability applications, such as military, medical life-support or life-sustaining equipment are specifically not recommended without additional processing by ams AG for each application. This product is provided by ams AG "AS IS" and any express or implied warranties, including, but not limited to the implied warranties of merchantability and fitness for a particular purpose are disclaimed.

ams AG shall not be liable to recipient or any third party for any damages, including but not limited to personal injury, property damage, loss of profits, loss of use, interruption of business or indirect, special, incidental or consequential damages, of any kind, in connection with or arising out of the furnishing, performance or use of the technical data herein. No obligation or liability to recipient or any third party shall arise or flow out of ams AG rendering of technical or other services.

Document Status

Document Status	Product Status	Definition
Product Preview	Pre-Development	Information in this datasheet is based on product ideas in the planning phase of development. All specifications are design goals without any warranty and are subject to change without notice
Preliminary Datasheet	Pre-Production	Information in this datasheet is based on products in the design, validation or qualification phase of development. The performance and parameters shown in this document are preliminary without any warranty and are subject to change without notice
Datasheet	Production	Information in this datasheet is based on products in ramp-up to full production or full production which conform to specifications in accordance with the terms of ams AG standard warranty as given in the General Terms of Trade
Datasheet (discontinued)	Discontinued	Information in this datasheet is based on products which conform to specifications in accordance with the terms of ams AG standard warranty as given in the General Terms of Trade, but these products have been superseded and should not be used for new designs

Revision Information

Changes from 1-00 (2016-Jun-16) to current revision 1-01 (2016-Jun-17)	Page
Updated Figure 6	5

Note(s):

1. Page and figure numbers for the previous version may differ from page and figure numbers in the current revision.
2. Correction of typographical errors is not explicitly mentioned.

Content Guide

1	General Description
1	Key Benefits & Features
2	Applications
3	Block Diagram
4	Pin Assignments
5	Absolute Maximum Ratings
6	Electrical Characteristics
6	Operating Conditions
6	Analog System Parameters
7	Detailed Descriptions
7	Digital System Parameters
8	Configuration Register
9	<i>Data Width, Bit D4</i>
9	<i>Alert, Bit D5</i>
9	<i>Conversion Rate, Bit D6-D7</i>
11	<i>Sleep Mode, Bit D8</i>
11	<i>Interrupt Mode, Bit D9</i>
12	<i>Polarity, Bit D10</i>
13	<i>Consecutive Faults, Bits D11-D12</i>
13	<i>Single Shot Conversion, Bit D15</i>
14	High- and Low-Limit Registers
16	Temperature Register
18	Serial Interface
18	Bus Description
18	Data Interface
19	Bus Address
19	Read/Write Operation
20	Slave Operation
20	<i>Slave Receiver Mode</i>
20	<i>Slave Transmitter Mode</i>
20	<i>Alert Function</i>
21	<i>General Call</i>
21	<i>High Speed Mode</i>
22	<i>Summary of Bus Commands</i>
22	<i>Timeout Function</i>
22	<i>Bus Conditions</i>
23	Timing Characteristics
24	Timing Diagrams
26	Application Information
27	External Components
28	Package Drawings & Markings
30	Ordering & Contact Information
31	RoHS Compliant & ams Green Statement
32	Copyrights & Disclaimer
33	Document Status
34	Revision Information