

1. Product profile

1.1 General description

Passivated sensitive gate 4-Q triac in a SOT223 surface-mountable plastic package

1.2 Features and benefits

- Direct interfacing to logic level ICs
- Direct interfacing to low power gate drive circuits
- High blocking voltage of 600V
- Sensitive gate in four quadrants
- Surface-mountable package

1.3 Applications

- General purpose low power motor control
- Home appliances
- Industrial process control
- Low power AC Fan controllers



1.4 Quick reference data

Table 1. Quick reference

Symbol	Parameter	Conditions	Min	Typ	Max	Unit
V_{DRM}	repetitive peak off-state voltage		-	-	600	V
$I_{\text{T(RMS)}}$	RMS on-state current	half sine wave; $T_{\text{sp}} \leq 89\text{ °C}$; see Figure 1 and 4	-	-	1	A
Static characteristics						
I_{GT}	gate trigger current	$V_{\text{D}} = 12\text{ V}$; $T_{\text{j}} = 25\text{ °C}$; T2+ G-; see Figure 6	-	-	3	mA
		$V_{\text{D}} = 12\text{ V}$; $T_{\text{j}} = 25\text{ °C}$; T2- G-	-	-	3	mA
		$V_{\text{D}} = 12\text{ V}$; $T_{\text{j}} = 25\text{ °C}$; T2+ G+	-	-	3	mA
		$V_{\text{D}} = 12\text{ V}$; $T_{\text{j}} = 25\text{ °C}$; T2- G+	-	-	5	mA

2. Pinning information

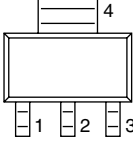
Table 2. Pinning information

Pin	Symbol	Description	Simplified outline	Graphic symbol
1	T1	main terminal 1	 <p>SOT223 (SC-73)</p>	 <p><i>sym051</i></p>
2	T2	main terminal 2		
3	G	gate		
4	T2	main terminal 2		

3. Ordering information

Table 3. Ordering information

Type number	Package		Version
	Name	Description	
Z0103MN	SC-73	plastic surface-mounted package with increased heatsink; 4 leads	SOT223

4. Limiting values

Table 4. Limiting values

In accordance with the Absolute Maximum Rating System (IEC 60134).

Symbol	Parameter	Conditions	Min	Max	Unit
V_{DRM}	repetitive peak off-state voltage		-	600	V
$I_{T(RMS)}$	RMS on-state current	half sine wave; $T_{sp} \leq 89\text{ }^\circ\text{C}$; see Figure 1 and 4	-	1	A
di_T/dt	rate of rise of on-state current	$I_T = 1\text{ A}$; $I_G = 20\text{ mA}$; $di_G/dt = 100\text{ mA}/\mu\text{s}$; T2+ G-	-	50	A/ μs
		$I_T = 1\text{ A}$; $I_G = 20\text{ mA}$; $di_G/dt = 100\text{ mA}/\mu\text{s}$; T2+ G+	-	50	A/ μs
		$I_T = 1\text{ A}$; $I_G = 20\text{ mA}$; $di_G/dt = 100\text{ mA}/\mu\text{s}$; T2- G+	-	20	A/ μs
		$I_T = 1\text{ A}$; $I_G = 20\text{ mA}$; $di_G/dt = 100\text{ mA}/\mu\text{s}$; T2- G-	-	50	A/ μs
I_{GM}	peak gate current		-	1	A
P_{GM}	peak gate power		-	2	W
T_{stg}	storage temperature		-40	150	$^\circ\text{C}$
T_j	junction temperature		-	125	$^\circ\text{C}$
I_{TSM}	non-repetitive peak on-state current	full sine wave; $t_p = 16.7\text{ ms}$; $T_{j(\text{init})} = 25\text{ }^\circ\text{C}$	-	8.5	A
		full sine wave; $t_p = 20\text{ ms}$; $T_{j(\text{init})} = 25\text{ }^\circ\text{C}$; see Figure 2 and 3	-	8	A
I^2t	I^2t for fusing	$t_p = 10\text{ ms}$; sine-wave pulse	-	0.32	A ² s
$P_{G(AV)}$	average gate power		-	0.1	W

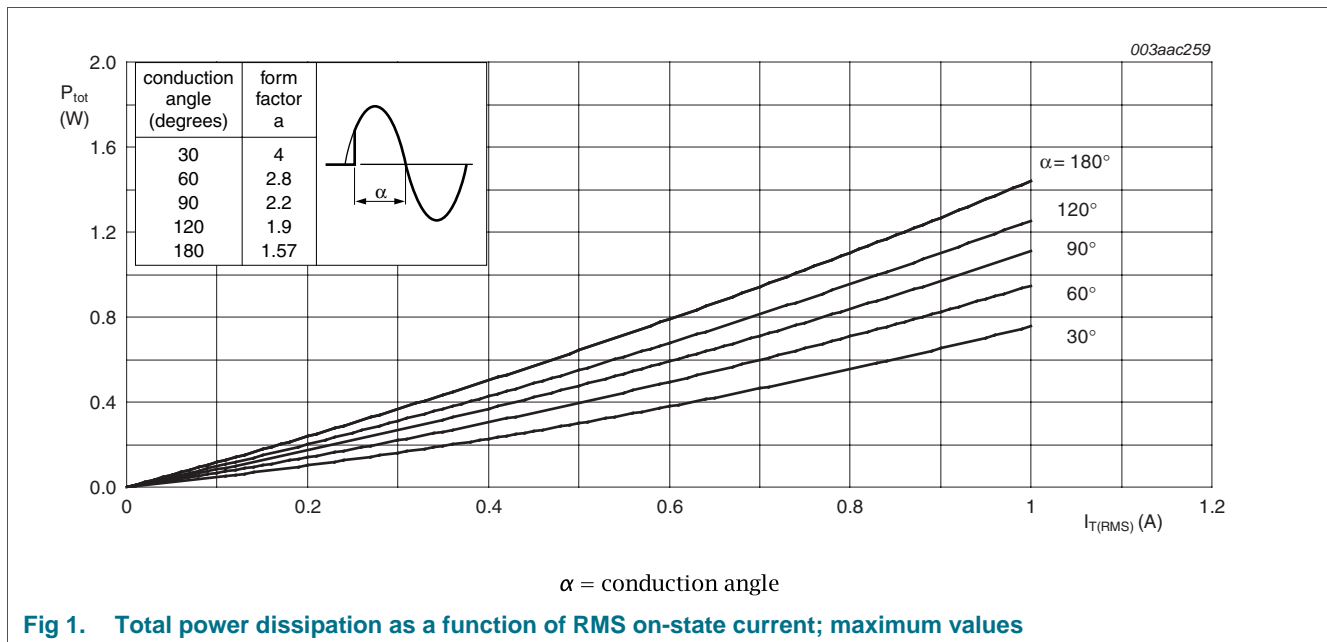

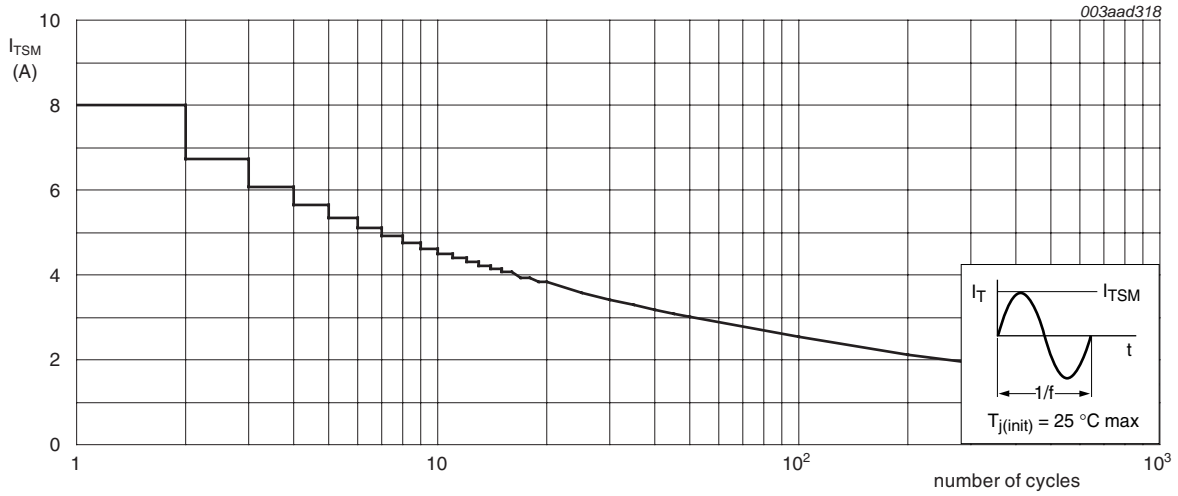

f = 50 Hz

Fig 2. Non-repetitive peak on-state current as a function of the number of sinusoidal current cycles; maximum values

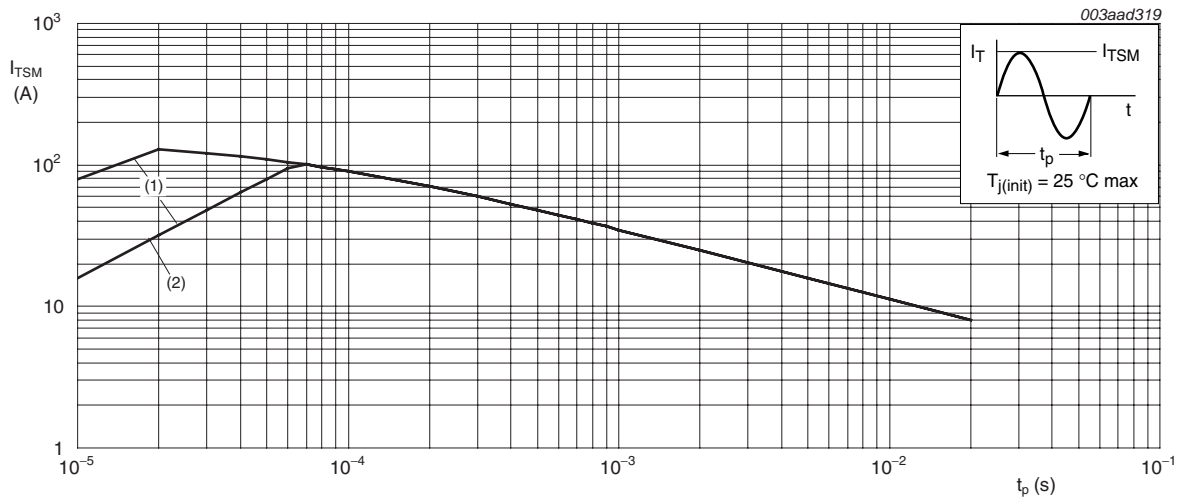

$t_p \leq 20$ ms; (1) is dI_T/dt limit;
 (2) is T2 – G + quadrant limit

Fig 3. Non-repetitive peak on-state current as a function of pulse width; maximum values

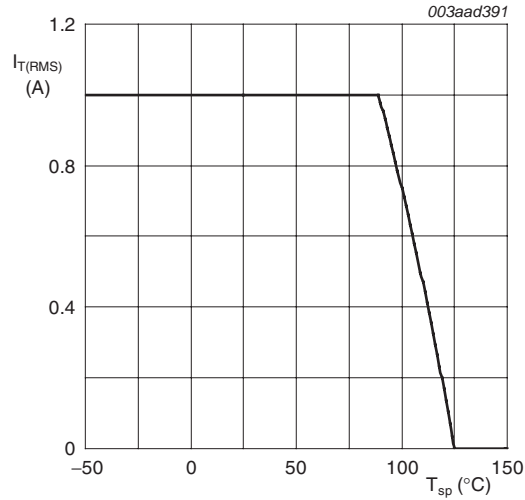

Fig 4. Maximum permissible RMS on-state current as a function of solder point temperature; typical values.

5. Thermal characteristics

Table 5. Thermal characteristics

Symbol	Parameter	Conditions	Min	Typ	Max	Unit
$R_{th(j-sp)}$	thermal resistance from junction to solder point	see Figure 5	-	-	25	K/W
$R_{th(j-a)}$	thermal resistance from junction to ambient		-	150	-	K/W
			-	60	-	K/W

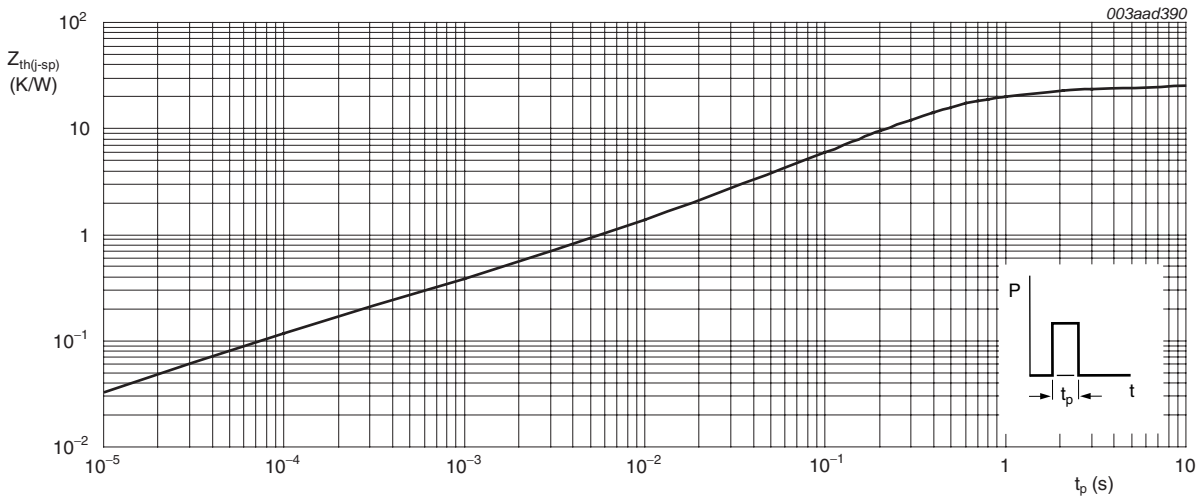
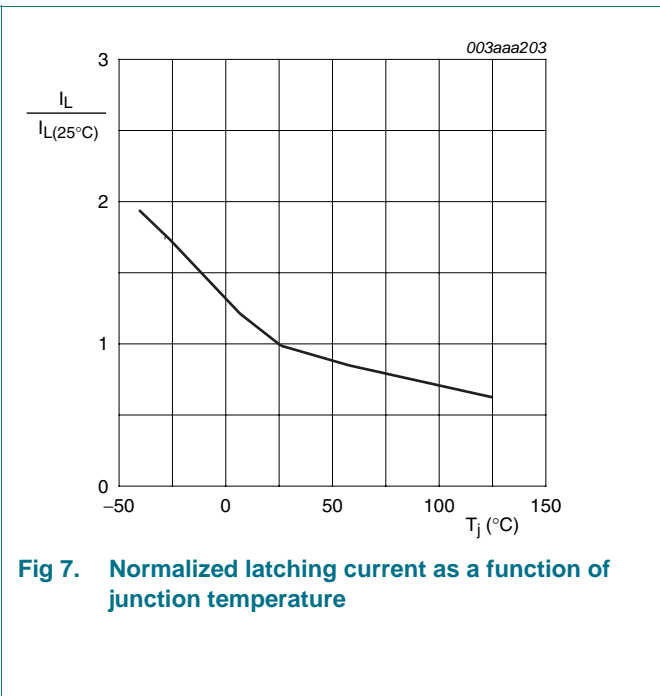
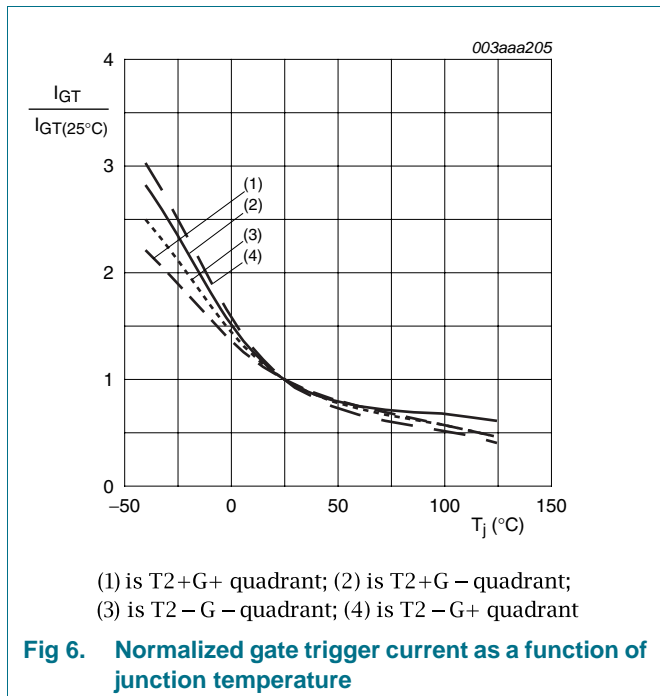

Fig 5. Transient thermal impedance from junction to solder point as a function of pulse duration

6. Characteristics

Table 6. Characteristics

Symbol	Parameter	Conditions	Min	Typ	Max	Unit
Static characteristics						
I_{GT}	gate trigger current	$V_D = 12\text{ V}; T_j = 25\text{ }^\circ\text{C}; T2+ G-;$ see Figure 6	-	-	3	mA
		$V_D = 12\text{ V}; T_j = 25\text{ }^\circ\text{C}; T2- G-$	-	-	3	mA
		$V_D = 12\text{ V}; T_j = 25\text{ }^\circ\text{C}; T2+ G+$	-	-	3	mA
		$V_D = 12\text{ V}; T_j = 25\text{ }^\circ\text{C}; T2- G+$	-	-	5	mA
I_L	latching current	$V_D = 12\text{ V}; T_j = 25\text{ }^\circ\text{C}; I_G = 0.1\text{ A}; T2+ G-;$ see Figure 7	-	-	15	mA
		$V_D = 12\text{ V}; T_j = 25\text{ }^\circ\text{C}; I_G = 0.1\text{ A}; T2+ G+$	-	-	7	mA
		$V_D = 12\text{ V}; T_j = 25\text{ }^\circ\text{C}; I_G = 0.1\text{ A}; T2- G+$	-	-	7	mA
		$V_D = 12\text{ V}; T_j = 25\text{ }^\circ\text{C}; I_G = 0.1\text{ A}; T2- G-$	-	-	7	mA
I_H	holding current	$V_D = 12\text{ V}; T_j = 25\text{ }^\circ\text{C};$ see Figure 10	-	-	7	mA
V_T	on-state voltage	$I_T = 1\text{ A};$ see Figure 8	-	1.3	1.6	V
V_{GT}	gate trigger voltage	$I_T = 0.1\text{ A}; V_D = 12\text{ V}; T_j = 25\text{ }^\circ\text{C};$ see Figure 9	-	-	1.3	V
		$I_T = 0.1\text{ A}; V_D = 600\text{ V}; T_j = 125\text{ }^\circ\text{C}$	0.2	-	-	V
I_D	off-state current	$V_D = 600\text{ V}; T_j = 125\text{ }^\circ\text{C}$	-	-	0.5	mA
Dynamic characteristics						
dV_{D}/dt	rate of rise of off-state voltage	$V_{DM} = 402\text{ V}; T_j = 110\text{ }^\circ\text{C};$ gate open circuit; see Figure 11	10	-	-	V/ μ s
dV_{com}/dt	rate of rise of commutating voltage	$V_D = 400\text{ V}; T_j = 110\text{ }^\circ\text{C};$ $di_{com}/dt = 0.44\text{ A/ms};$ gate open circuit	0.5	-	-	V/ μ s



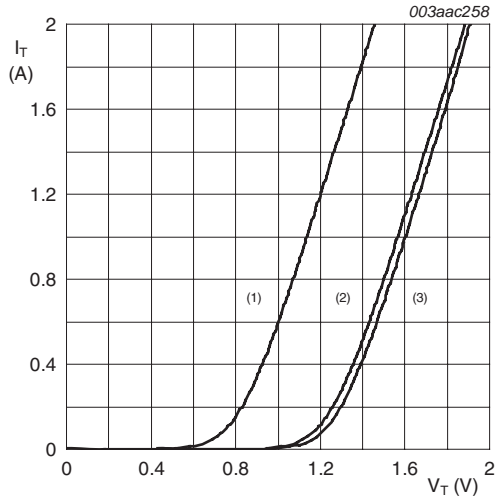

$V_0 = 1.254 \text{ V}; R_s = 0.31 \Omega$
 (1) $T_j = 125 \text{ }^\circ\text{C}$; typical values
 (2) $T_j = 125 \text{ }^\circ\text{C}$; maximum values
 (3) $T_j = 25 \text{ }^\circ\text{C}$; maximum values

Fig 8. On-state current as a function of on-state voltage

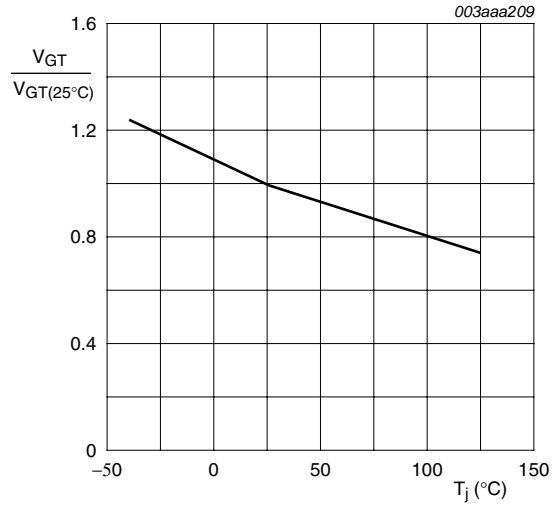

Fig 9. Normalized gate trigger voltage as a function of junction temperature

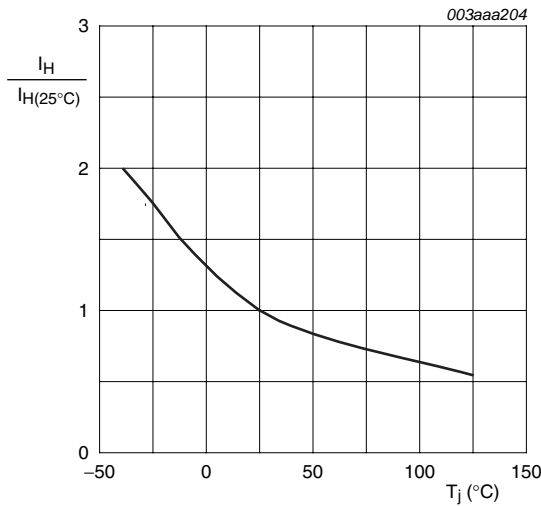
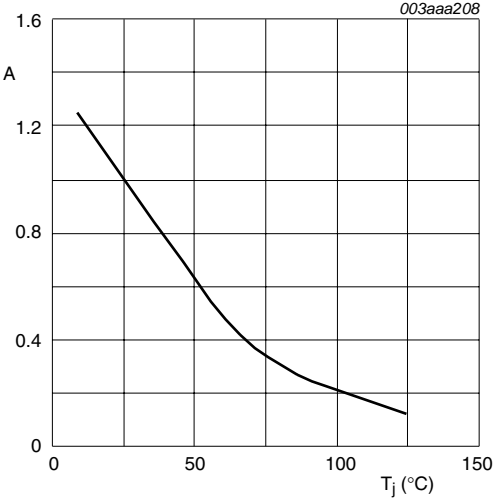

Fig 10. Normalized holding current as a function of junction temperature



$$A = \frac{dV_D/dt}{dV_{D(25^\circ C)}/dt}$$

Fig 11. Normalized critical rate of rise of off-state voltage as a function of junction temperature; typical values

7. Package outline

Plastic surface-mounted package with increased heatsink; 4 leads

SOT223

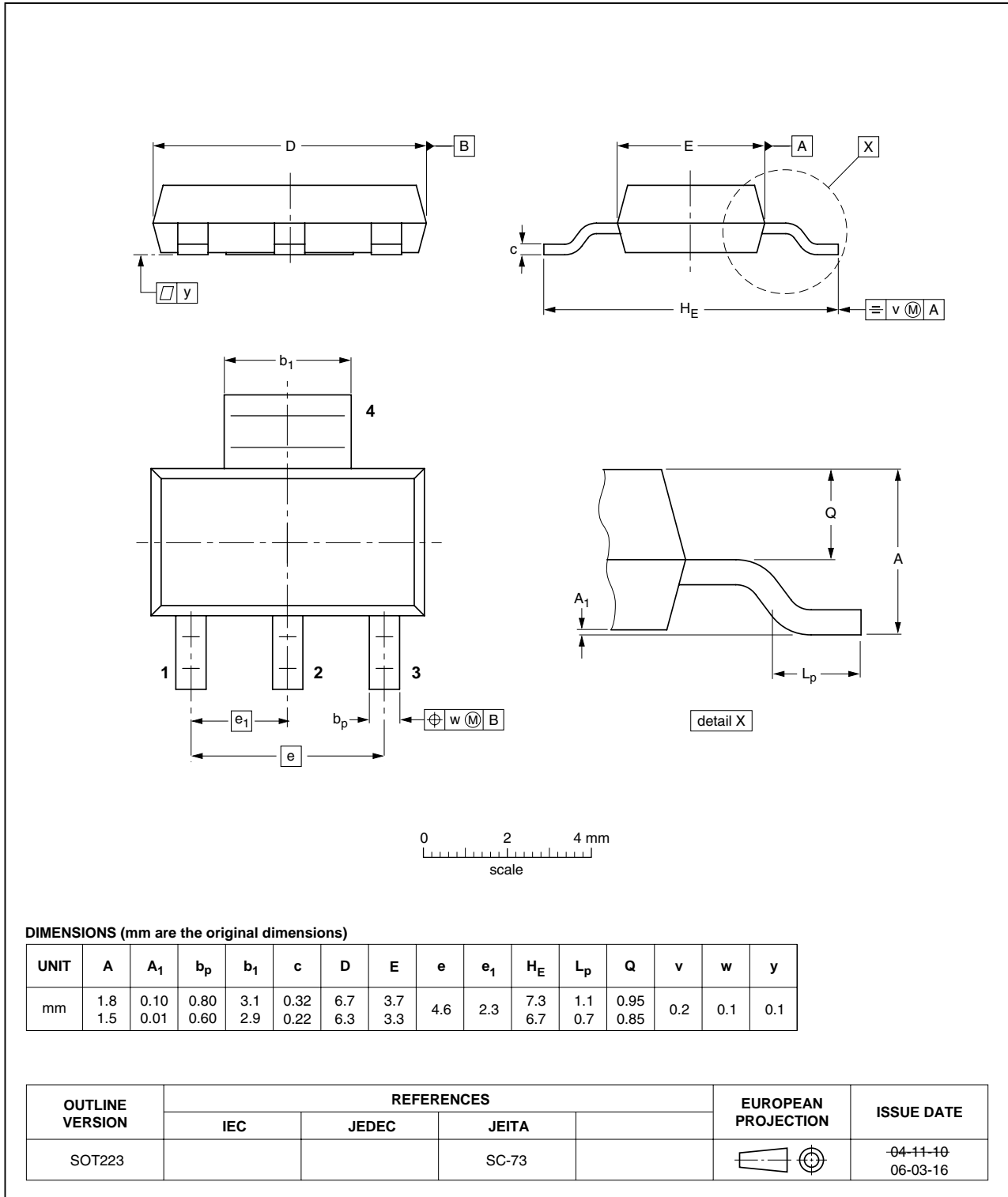

Fig 12. Package outline SOT223 (SC-73)

8. Revision history

Table 7. Revision history

Document ID	Release date	Data sheet status	Change notice	Supersedes
Z0103MN_3	20090805	Product data sheet	-	Z0103_07_09_SERIES-02
Modifications:		<ul style="list-style-type: none">• The format of this data sheet has been redesigned to comply with the new identity guidelines of NXP Semiconductors.• Legal texts have been adapted to the new company name where appropriate.• Type number Z0103MN separated from data sheet Z0103_07_09_SERIES-02.		
Z0103_07_09_SERIES-02 (9397 750 10102)	20020912	Product data	-	Z0103_07_09_SERIES-01
Z0103_07_09_SERIES-01 (9397 750 09419)	20020411	Product data	-	-

9. Legal information

9.1 Data sheet status

Document status ^{[1][2]}	Product status ^[3]	Definition
Objective [short] data sheet	Development	This document contains data from the objective specification for product development.
Preliminary [short] data sheet	Qualification	This document contains data from the preliminary specification.
Product [short] data sheet	Production	This document contains the product specification.

[1] Please consult the most recently issued document before initiating or completing a design.

[2] The term 'short data sheet' is explained in section "Definitions".

[3] The product status of device(s) described in this document may have changed since this document was published and may differ in case of multiple devices. The latest product status information is available on the Internet at URL <http://www.nxp.com>.

9.2 Definitions

Draft — The document is a draft version only. The content is still under internal review and subject to formal approval, which may result in modifications or additions. NXP Semiconductors does not give any representations or warranties as to the accuracy or completeness of information included herein and shall have no liability for the consequences of use of such information.

Short data sheet — A short data sheet is an extract from a full data sheet with the same product type number(s) and title. A short data sheet is intended for quick reference only and should not be relied upon to contain detailed and full information. For detailed and full information see the relevant full data sheet, which is available on request via the local NXP Semiconductors sales office. In case of any inconsistency or conflict with the short data sheet, the full data sheet shall prevail.

9.3 Disclaimers

General — Information in this document is believed to be accurate and reliable. However, NXP Semiconductors does not give any representations or warranties, expressed or implied, as to the accuracy or completeness of such information and shall have no liability for the consequences of use of such information.

Right to make changes — NXP Semiconductors reserves the right to make changes to information published in this document, including without limitation specifications and product descriptions, at any time and without notice. This document supersedes and replaces all information supplied prior to the publication hereof.

Suitability for use — NXP Semiconductors products are not designed, authorized or warranted to be suitable for use in medical, military, aircraft, space or life support equipment, nor in applications where failure or malfunction of an NXP Semiconductors product can reasonably be expected to result in personal injury, death or severe property or environmental damage. NXP Semiconductors accepts no liability for inclusion and/or use of NXP Semiconductors products in such equipment or applications and therefore such inclusion and/or use is at the customer's own risk.

Applications — Applications that are described herein for any of these products are for illustrative purposes only. NXP Semiconductors makes no representation or warranty that such applications will be suitable for the specified use without further testing or modification.

Quick reference data — The Quick reference data is an extract of the product data given in the Limiting values and Characteristics sections of this document, and as such is not complete, exhaustive or legally binding.

Limiting values — Stress above one or more limiting values (as defined in the Absolute Maximum Ratings System of IEC 60134) may cause permanent damage to the device. Limiting values are stress ratings only and operation of the device at these or any other conditions above those given in the Characteristics sections of this document is not implied. Exposure to limiting values for extended periods may affect device reliability.

Terms and conditions of sale — NXP Semiconductors products are sold subject to the general terms and conditions of commercial sale, as published at <http://www.nxp.com/profile/terms>, including those pertaining to warranty, intellectual property rights infringement and limitation of liability, unless explicitly otherwise agreed to in writing by NXP Semiconductors. In case of any inconsistency or conflict between information in this document and such terms and conditions, the latter will prevail.

No offer to sell or license — Nothing in this document may be interpreted or construed as an offer to sell products that is open for acceptance or the grant, conveyance or implication of any license under any copyrights, patents or other industrial or intellectual property rights.

Export control — This document as well as the item(s) described herein may be subject to export control regulations. Export might require a prior authorization from national authorities.

9.4 Trademarks

Notice: All referenced brands, product names, service names and trademarks are the property of their respective owners.

10. Contact information

For more information, please visit: <http://www.nxp.com>

For sales office addresses, please send an email to: salesaddresses@nxp.com

11. Contents

1	Product profile	1
1.1	General description	1
1.2	Features and benefits	1
1.3	Applications	1
1.4	Quick reference data	1
2	Pinning information	2
3	Ordering information	2
4	Limiting values	3
5	Thermal characteristics	5
6	Characteristics	6
7	Package outline	9
8	Revision history	10
9	Legal information	11
9.1	Data sheet status	11
9.2	Definitions	11
9.3	Disclaimers	11
9.4	Trademarks	11
10	Contact information	11

Please be aware that important notices concerning this document and the product(s) described herein, have been included in section 'Legal information'.

© NXP B.V. 2009.

All rights reserved.

For more information, please visit: <http://www.nxp.com>

For sales office addresses, please send an email to: salesaddresses@nxp.com

Date of release: 5 August 2009

Document identifier: Z0103MN_3

founded by

PHILIPS