

LOW DROP FIXED AND ADJUSTABLE POSITIVE VOLTAGE REGULATOR

The KIA1117DS × × Series are a Low Drop Voltage Regulator able to provide up to 1A of output current, available even in adjustable version (Vref=1.25V)

FEATURES

- Low Dropout Voltage : 1.3V/Typ. (Iout=1.0A)
- Very Low Quiescent Current : 2mA(Typ)
- Output Current up to 1A
- Fixed Output Voltage of 1.2V, 1.5V, 1.8V, 2.5V, 3.3V, 5.0V
- Adjustable Version Availability : Vref=1.25V
- Internal Current and Thermal Limit
- A Minimum of 10μF for stability
- Compatible with tantalum capacitor, electrolytic capacitor, MLCC
- Available in ± 2%(at 25 °C)

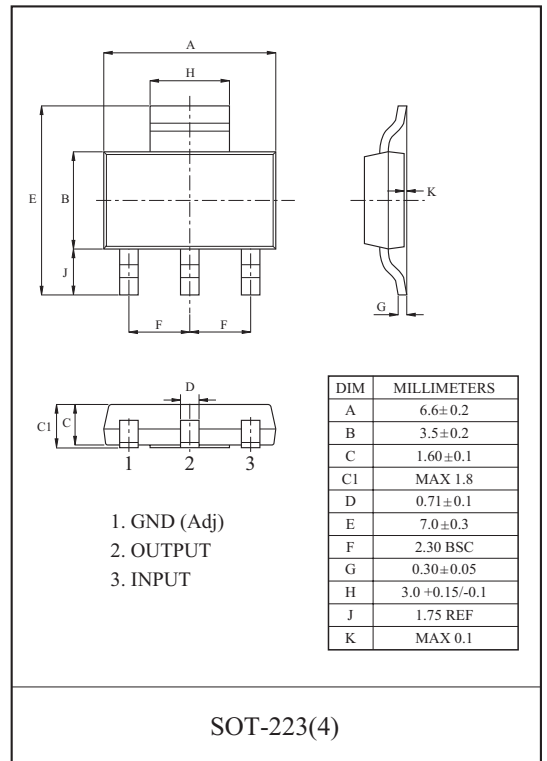

LINE UP

ITEM	OUTPUT VOLTAGE (V)	PACKAGE
KIA1117DS00	Adjustable (1.25~12V)	DS : SOT-223(4)
KIA1117DS12	1.2	
KIA1117DS15	1.5	
KIA1117DS18	1.8	
KIA1117DS25	2.5	
KIA1117DS33	3.3	
KIA1117DS50	5.0	

KIA1117DS00~KIA1117DS50

ORDERING INFORMATION

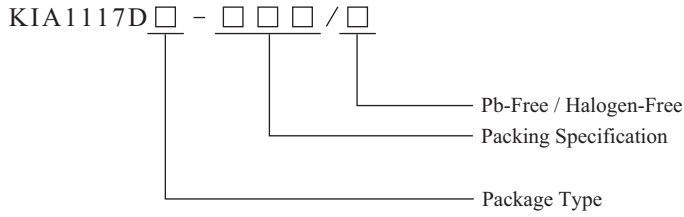

ITEM	Package Code		Packing Specification		Pb-Free / Halogen-Free	
	Code	Package				
KIA1117D	S	SOT-223(4)	RTK	RTK type	P	Pb-Free
			RTF	RTF type	H	Halogen-Free

MAXIMUM RATINGS (Ta=25 °C)

CHARACTERISTIC	SYMBOL	RATING	UNIT
Input Voltage	V_{IN}	15	V
Output Current	I_{OUT}	1.0	A
Power Dissipation 1 (No Heatsink)	P_{D1}	1.0	W
Power Dissipation 2 (Infinite Heatsink)	P_{D2}	8.3	W
Maximum operating Junction Temperature	$T_{j(max)}$	150	
Operating Temperature	T_{opr}	-40 85	
Storage Temperature	T_{stg}	-40 150	

Note) Package Mounted on FR-4 PCB 36mm × 18mm × 1.5mm.
: mounting pad for the GND Lead min. 6cm²

KIA1117DS00~KIA1117DS50

ELECTRICAL CHARACTERISTICS

Unless otherwise specified, $T_j=25$

CHARACTERISTIC	ITEM	SYMBOL	TEST CONDITIONS	MIN.	TYP.	MAX.	UNIT
Reference Voltage	KIA1117-Adj	V_{REF}	$V_{IN}=3.25V, I_{OUT} = 1A$	1.225	1.25	1.275	V
Output Voltage	KIA1117-12	V_{OUT}	$V_{IN}=3.2V, I_{OUT} = 1A$	1.176	1.2	1.224	V
	KIA1117-15	V_{OUT}	$V_{IN}=3.5V, I_{OUT} = 1A$	1.47	1.5	1.53	V
	KIA1117-18	V_{OUT}	$V_{IN}=3.8V, I_{OUT} = 1A$	1.764	1.8	1.836	V
	KIA1117-25	V_{OUT}	$V_{IN}=4.5V, I_{OUT} = 1A$	2.45	2.5	2.55	V
	KIA1117-33	V_{OUT}	$V_{IN}=5.3V, I_{OUT} = 1A$	3.234	3.3	3.366	V
	KIA1117-50	V_{OUT}	$V_{IN}=7.0V, I_{OUT} = 1A$	4.9	5	5.1	V
Line Regulation	KIA1117-12	Reg Line	$2.7V, V_{IN} = 10V, I_{OUT}=10mA$	-	0.1	0.2	%/V
	-		$V_{OUT}+1.5V, V_{IN} = 12V, I_{OUT}=10mA$	-	0.1	0.2	%/V
Load Regulation	-	Reg Load	$10mA, I_{OUT} = 1A, V_{IN}=V_{OUT}+1.5V$	-	10	30	mV
Adjustable Pin Current	KIA1117-Adj	I_{ADJ}	$V_{IN}=5V, I_{OUT} = 1A$	-	55	120	μA
Minimum Load Current	KIA1117-Adj	I_{min}	$V_{IN}=V_{OUT}+1.5V$	-	2	10	mA
Quiescent Current	KIA1117-12	I_{B1}	$V_{IN}=10V, I_{OUT}=0A$	-	2	5	mA
	-	I_{B2}	$V_{IN}=12V, I_{OUT}=0A$				
Current Limit	-	I_{limit}	$V_{IN}=V_{OUT}+2.0V, T_j=25$	1	-	-	A
Dropout Voltage	-	V_{DROP}	$I_{OUT}=1A$	-	1.3	1.5	V
			$I_{OUT}=100mA$	-	1.23	1.3	V
Temperature Stability	-	TCV_O	$V_{IN}=V_{OUT}+1.5V, I_{OUT}=10mA, T_j=-20\sim 125$	-	± 100	-	ppm/

KIA1117DS00~KIA1117DS50

Fig.1 Application Circuit-1 (Fixed-Type)

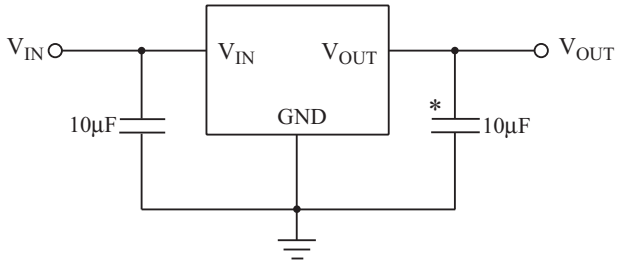

* Note 1) Recommend using 10uF tan capacitor, MLCC to assure circuit stability.

** Note 2) To meet the minimum load current (>10mA) requirement, R1 is recommended to be 125 ohm or lower. As KIA1117-ADJ can keep itself stable at load current about 2mA, R1 is not allowed to be higher than 625 ohm.

Fig.2 Application Circuit-2 (Adjustable-Type)

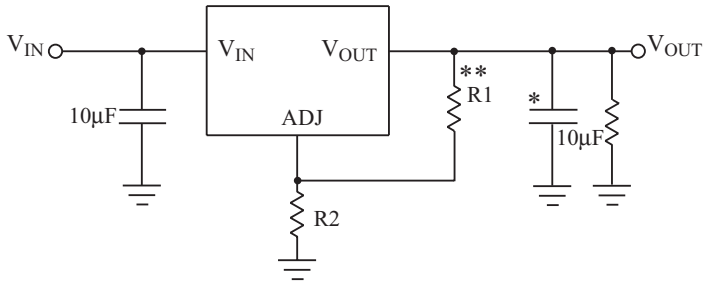

$$V_{OUT}=1.25 \times (1+R2/R1) + I_{ADJ} \times R2$$

KIA1117DS00~KIA1117DS50

Fig. 3 KIA1117-ADJ V_{OUT} - V_{IN}

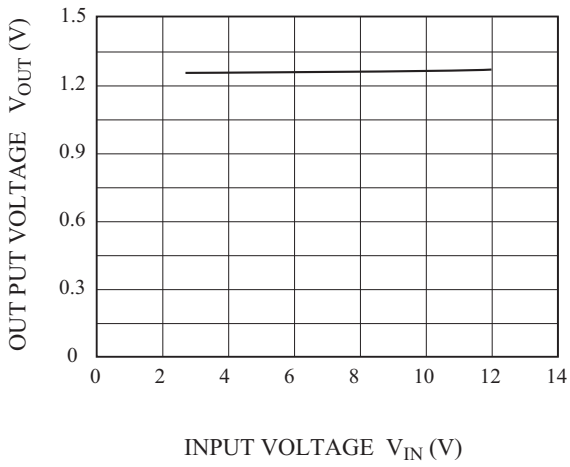

Fig. 4 KIA1117-ADJ V_{OUT} - I_{OUT}

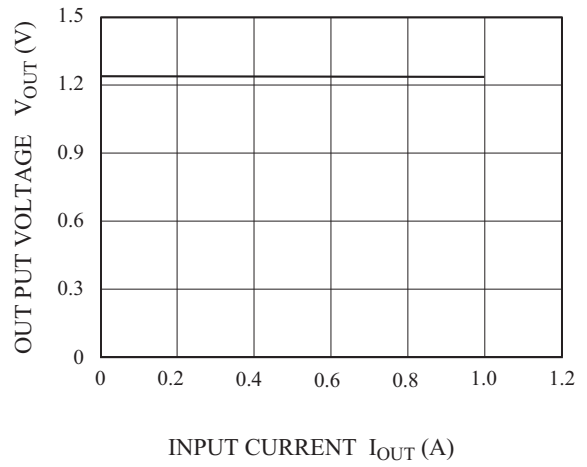

Fig. 5 KIA1117-ADJ DROPOUT - I_{OUT}

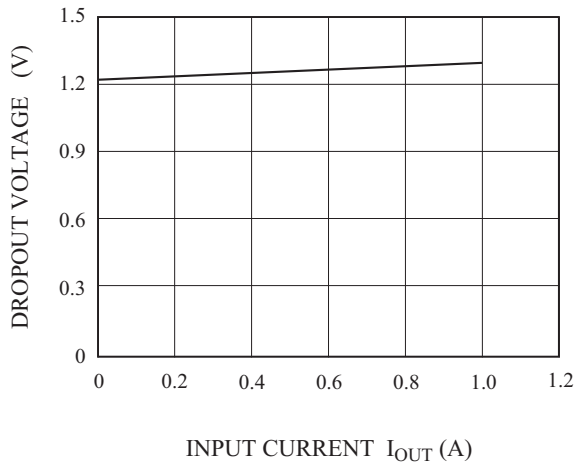

Fig. 6 KIA1117-ADJ V_{OUT} - TEMP

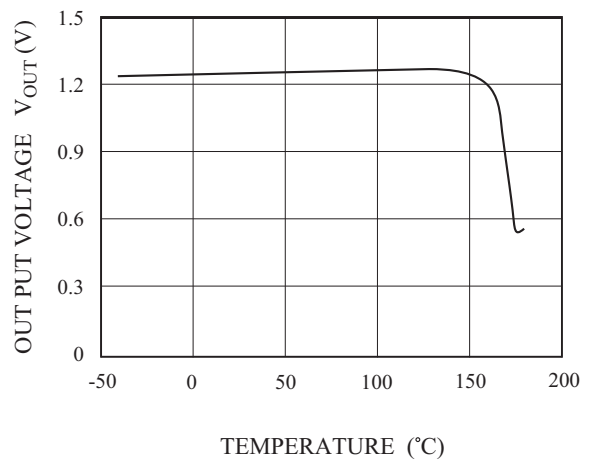

Fig.7 P_D - T_a

