

## 160-1597 Solder terminal, turreted

Recommended mounting hole .094 (2,37), #42 drill

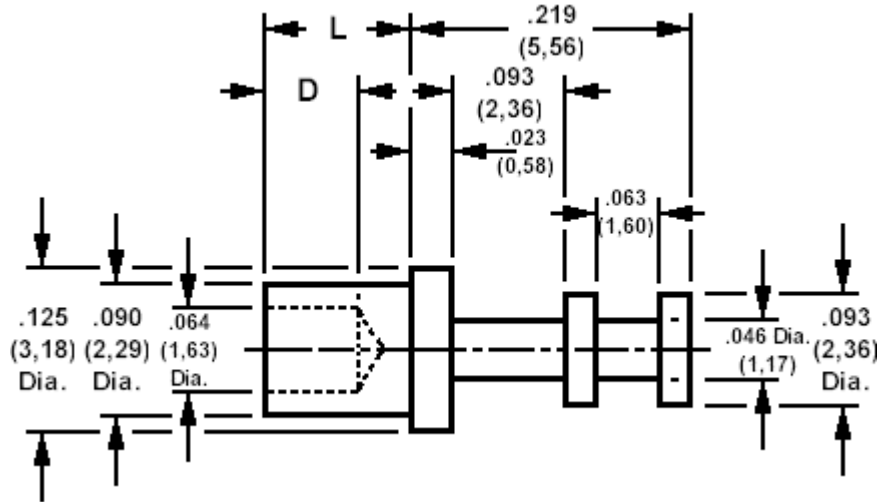

### How to order code

**160-1597-XX-YY-00**

Basic Part No XX = L dimension, YY = Plating Finish

DIMENSIONS (XX)				
Basic Part No	(XX)	L	Board Thickness	D
160-1597	-01	.063 (1,60)	.031 (0,79)	.068 (1,19)
	-02	.094 (2,39)	.062 (1,58)	.098 (2,48)
	-03	.125 (3,18)	.094 (2,38)	.098 (2,48)
	-04	.156 (3,96)	.125 (3,18)	.098 (2,48)

MATERIALS				
Component	Material	Finish (YY)		
		-01	-03	-05
Terminal	Brass	Silver	Gold	Electro Solder

SWAGE TOOLING	
Recommended Swaging Tools:-	
Anvil	435-6404-01-00-00
Roll punch	435-6604-01-00-00
Flare punch	435-6663-01-00-00