

High Performance 500 mA LDO in Thin and Extra Thin DFN Packages

Features

- Input Voltage Range: 2.5V to 5.5V
- Output Voltage Range: 1.0V to 5.0V
- Fixed Output Voltages: 1.1V, 1.2V, 1.8V, 2.8V, 3.0V, 3.3V
- $\pm 2\%$ Room Temperature Accuracy
- Low Quiescent Current 38 μA
- Stable with 2.2 μF Ceramic Output Capacitors
- Low Dropout Voltage 260 mV @ 500 mA
- Auto-Discharge and Internal Enable Pull-Down
- Thermal Shutdown and Current-Limit Protection
- 6-Pin 1.2 mm \times 1.2 mm Extra Thin DFN Package
- 6-Pin 1.2 mm \times 1.2 mm Thin DFN Package

Applications

- Portable Communication Equipment
- DSC, GPS, PMP, and PDAs
- Portable Medical Devices
- 5V POL Applications

General Description

The MIC5528 is a low-power, μCap , low dropout regulator designed for optimal performance in a very small footprint. It is capable of sourcing up to 500 mA of output current while only drawing 38 μA of operating current. This high performance LDO is a μCap design in a thermally enhanced 1.2 mm \times 1.2 mm extra thin (0.4 mm height) DFN package. It operates with small ceramic output capacitor for stability, thereby reducing required board space.

Ideal for battery-operated applications, the MIC5528 offers $\pm 2\%$ accuracy, extremely low dropout voltage (260 mV @ 500 mA), and can regulate output voltages down to 1.0V. Equipped with a TTL logic-compatible enable pin, the MIC5528 can be put into a zero-off-mode current state, drawing no current when disabled.

The MIC5528 is a μCap design, operating with very small ceramic output capacitors for stability, reducing required board space and component cost for space-critical applications. The MIC5528 has an operating junction temperature range of -40°C to 125°C .

Package Types

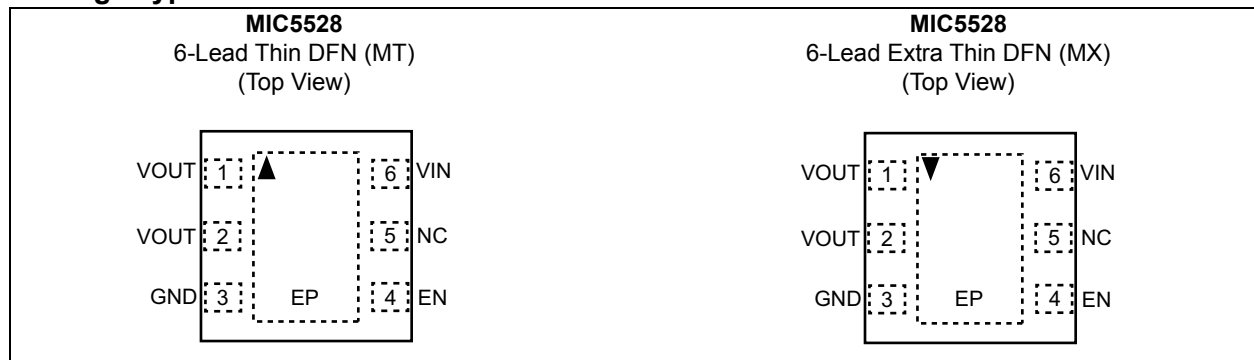

MIC5528

Typical Application Circuit

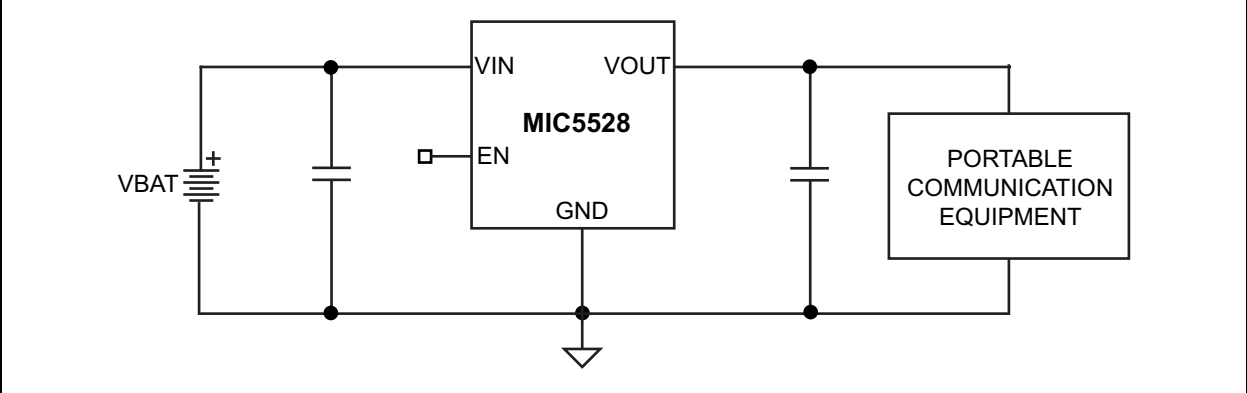

Functional Block Diagram

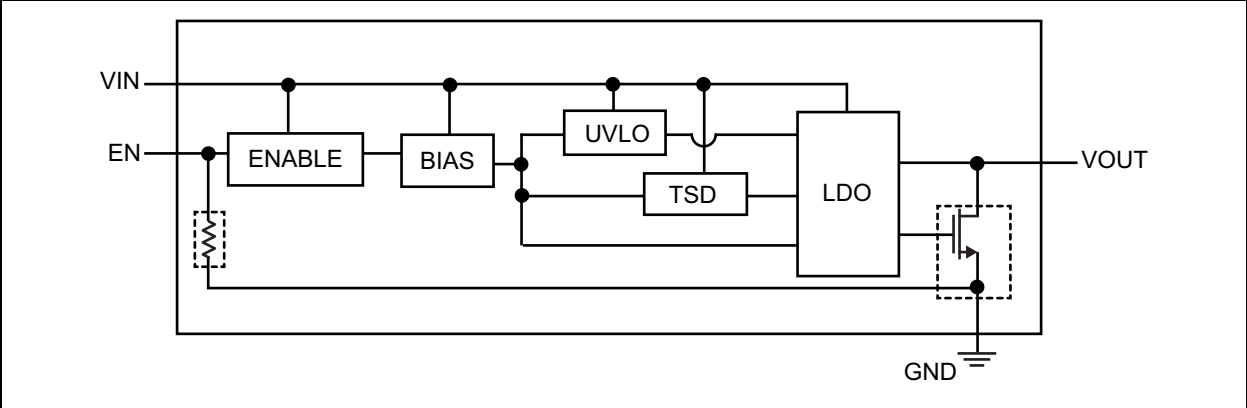

1.0 ELECTRICAL CHARACTERISTICS

Absolute Maximum Ratings †

Supply Voltage (V_{IN})	-0.3V to +6V
Enable Voltage (V_{EN})	-0.3V to V_{IN}
Power Dissipation (P_D)	Internally Limited, Note 1
ESD Rating (Note 2)	3 kV

Operating Ratings ‡

Supply Voltage (V_{IN})	+2.5V to +5.5V
Enable Voltage (V_{EN})	0V to V_{IN}

† **Notice:** Stresses above those listed under “Absolute Maximum Ratings” may cause permanent damage to the device. This is a stress rating only and functional operation of the device at those or any other conditions above those indicated in the operational sections of this specification is not intended. Exposure to maximum rating conditions for extended periods may affect device reliability.

‡ **Notice:** The device is not guaranteed to function outside its operating ratings.

Note 1: The maximum allowable power dissipation of any T_A (ambient temperature) is $P_{D(max)} = (T_{J(max)} - T_A)/\theta_{JA}$. Exceeding the maximum allowable power dissipation will result in excessive die temperature, and the regulator will go into thermal shutdown.

2: Devices are ESD sensitive. Handling precautions are recommended. Human body model, 1.5 k Ω in series with 100 pF.

TABLE 1-1: ELECTRICAL CHARACTERISTICS

Electrical Characteristics: $V_{IN} = V_{EN} = V_{OUT} + 1V$; $C_{IN} = C_{OUT} = 2.2 \mu F$; $I_{OUT} = 100 \mu A$; $T_J = +25^\circ C$, **bold** values indicate $-40^\circ C$ to $+85^\circ C$, unless noted. [Note 1](#)

Parameter	Symbol	Min.	Typ.	Max.	Units	Conditions
Output Voltage Accuracy	—	-2.0	± 1	+2.0	%	Variation from nominal V_{OUT}
		-3.0	—	+3.0		Variation from nominal V_{OUT} ; $-40^\circ C$ to $+85^\circ C$
Line Regulation	—	—	0.02	0.3	%/V	$V_{IN} = V_{OUT} + 1V$ to 5.5V; $I_{OUT} = 100 \mu A$
Load Regulation (Note 2)	—	—	14	65	mV	$I_{OUT} = 100 \mu A$ to 500 mA
Dropout Voltage (Note 3)	V_{DO}	—	80	180	mV	$I_{OUT} = 150$ mA
		—	260	500		$I_{OUT} = 500$ mA
Ground Pin Current (Note 4)	I_{GND}	—	38	55	μA	$I_{OUT} = 0$ mA
		—	42	65		$I_{OUT} = 500$ mA
Ground Pin Current in Shutdown	I_{SHDN}	—	0.05	1	μA	$V_{EN} = 0V$
Ripple Rejection	PSRR	—	70	—	dB	$f = 100$ Hz, $I_{OUT} = 100$ mA
		—	60	—		$f = 1$ kHz, $I_{OUT} = 100$ mA
Current Limit	I_{LIM}	525	800	—	mA	$V_{OUT} = 0V$
Output Voltage Noise	—	—	175	—	μV_{RMS}	$f = 10$ Hz to 100 kHz
Auto-Discharge NFET Resistance	—	—	25	—	Ω	$V_{EN} = 0V$; $V_{IN} = 3.6V$; $I_{OUT} = -3$ mA
Enable Input						
Enable Pull-Down Resistor	—	—	4	—	M Ω	—
Enable Input Voltage	V_{EN}	—	—	0.2	V	Logic low
		1.2	—	—		Logic high

MIC5528

TABLE 1-1: ELECTRICAL CHARACTERISTICS (CONTINUED)

Electrical Characteristics: $V_{IN} = V_{EN} = V_{OUT} + 1V$; $C_{IN} = C_{OUT} = 2.2 \mu F$; $I_{OUT} = 100 \mu A$; $T_J = +25^\circ C$, **bold** values indicate $-40^\circ C$ to $+85^\circ C$, unless noted. [Note 1](#)

Parameter	Symbol	Min.	Typ.	Max.	Units	Conditions
Enable Input Current	I_{EN}	—	0.01	1	μA	$V_{EN} = 0V$
		—	1.4	2		$V_{EN} = 5.5V$
Turn-On Time	t_{ON}	—	50	125	μs	$I_{OUT} = 150 mA$

Note 1: Specification for packaged product only.

- 2: Regulation is measured at constant junction temperature using low duty cycle pulse testing. Changes in output voltage due to heating effects are covered by the thermal regulation specification.
- 3: Dropout voltage is defined as the input-to-output differential at which the output voltage drops 2% below its nominal value measured at 1V differential. For outputs below 2.5V, dropout voltage is the input-to-output differential with the minimum input voltage 2.5V.
- 4: Ground pin current is the regulator quiescent current. The total current drawn from the supply is the sum of the load current plus the ground pin current.

TEMPERATURE SPECIFICATIONS (Note 1)

Parameters	Sym.	Min.	Typ.	Max.	Units	Conditions
Temperature Ranges						
Storage Temperature Range	T_S	-65	—	+150	°C	—
Maximum Junction Temperature Range	T_J	-40	—	+150	°C	—
Junction Operating Temperature Range	T_J	-40	—	+125	°C	—
Lead Temperature	—	—	—	+260	°C	Soldering, 10s
Package Thermal Resistances						
Thermal Resistance 6-Lead Extra Thin DFN	θ_{JA}	—	173	—	°C/W	—

Note 1: The maximum allowable power dissipation is a function of ambient temperature, the maximum allowable junction temperature and the thermal resistance from junction to air (i.e., T_A , T_J , θ_{JA}). Exceeding the maximum allowable power dissipation will cause the device operating junction temperature to exceed the maximum +125°C rating. Sustained junction temperatures above +125°C can impact the device reliability.

2.0 TYPICAL PERFORMANCE CURVES

Note: The graphs and tables provided following this note are a statistical summary based on a limited number of samples and are provided for informational purposes only. The performance characteristics listed herein are not tested or guaranteed. In some graphs or tables, the data presented may be outside the specified operating range (e.g., outside specified power supply range) and therefore outside the warranted range.

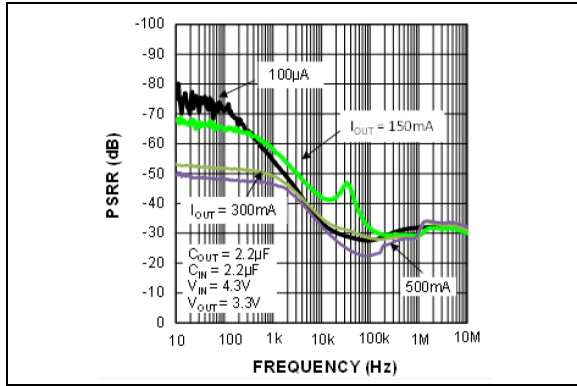

FIGURE 2-1: Power Supply Rejection Ratio.

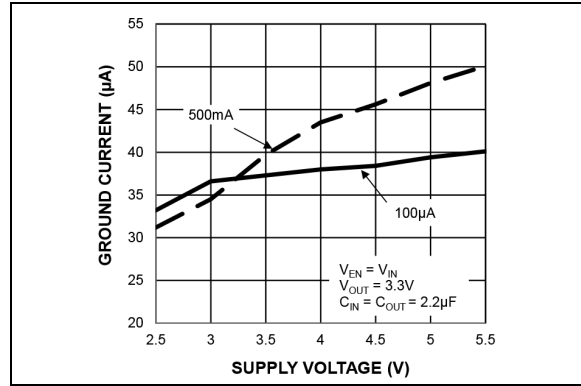

FIGURE 2-4: Ground Current vs. Supply Voltage.

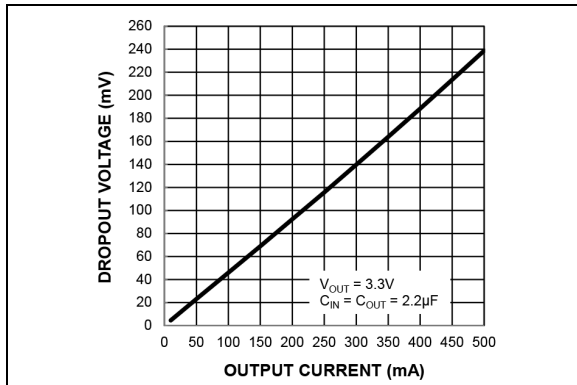

FIGURE 2-2: Dropout Voltage vs. Output Current.

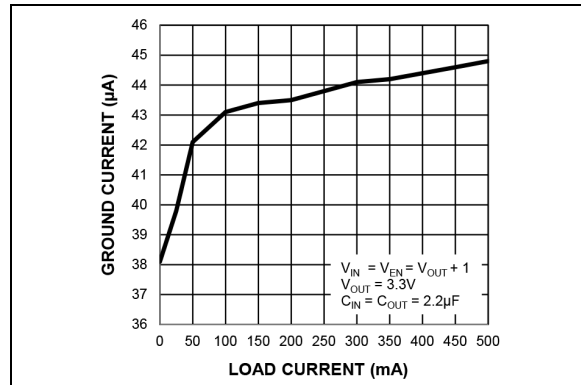

FIGURE 2-5: Ground Current vs. Load Current.

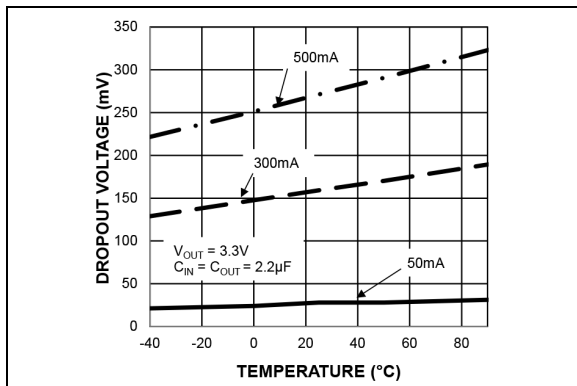

FIGURE 2-3: Dropout Voltage vs. Temperature.

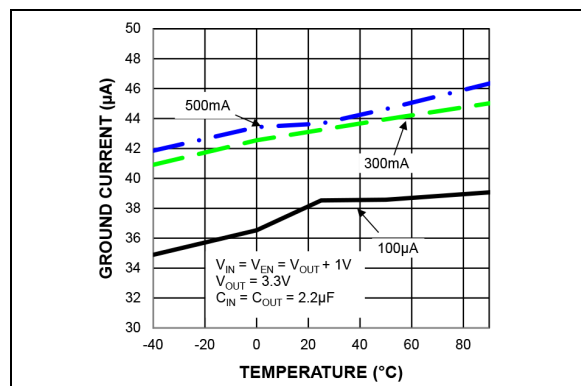

FIGURE 2-6: Ground Current vs. Temperature.

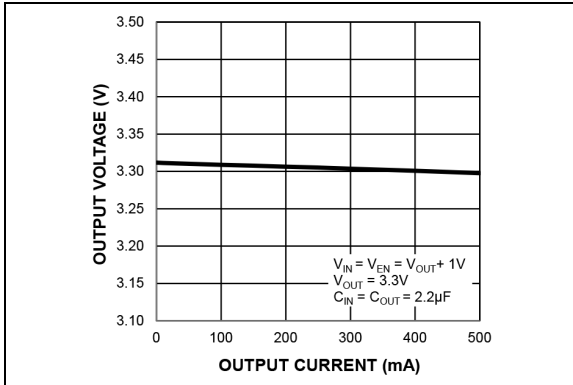

FIGURE 2-7: Output Voltage vs. Output Current.

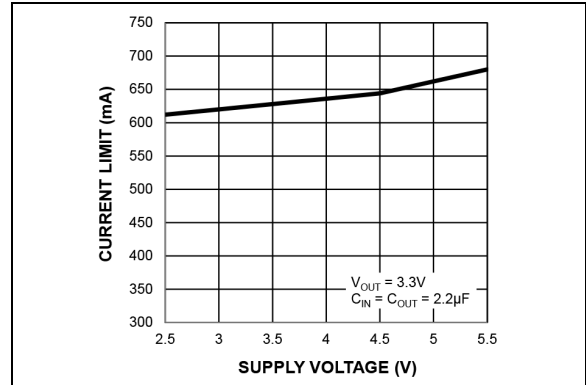

FIGURE 2-10: Current Limit vs. Supply Voltage.

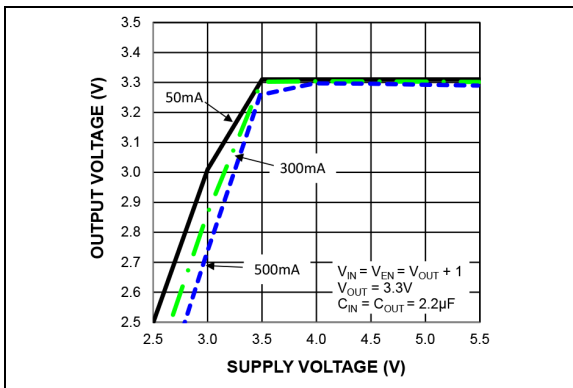

FIGURE 2-8: Output Voltage vs. Supply Voltage.

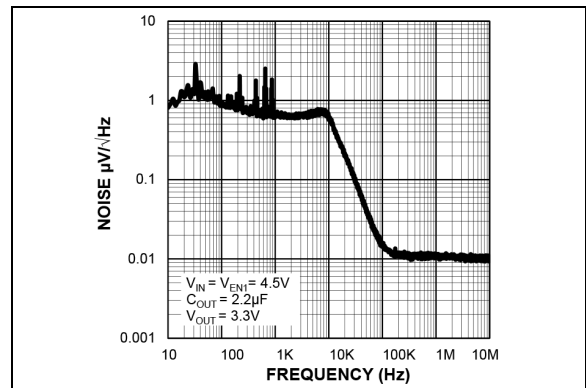

FIGURE 2-11: Output Noise Spectral Density (MIC5528-3.3YMT).

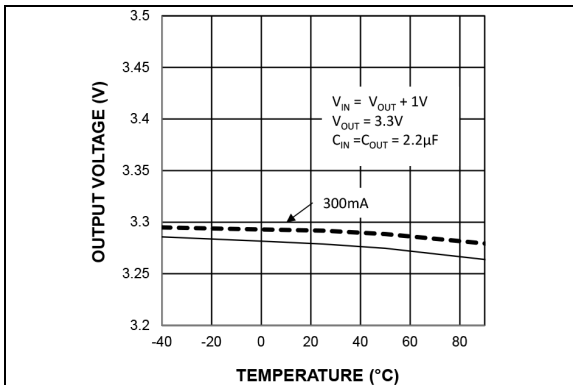

FIGURE 2-9: Output Voltage vs. Temperature.

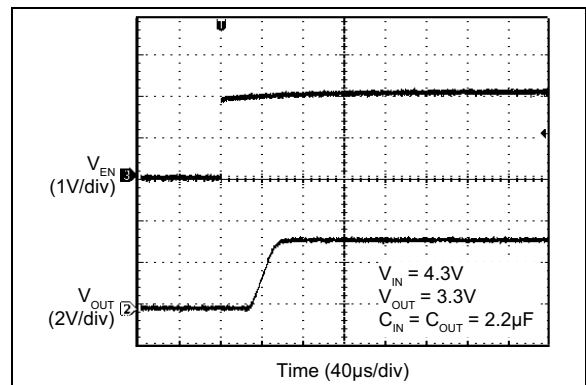

FIGURE 2-12: Enable Turn-On.

MIC5528

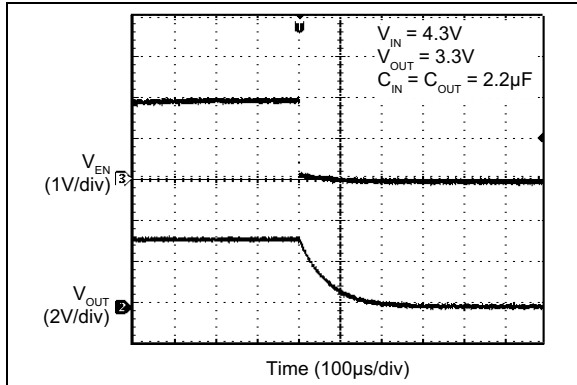

FIGURE 2-13: Auto-Discharge (No Load).

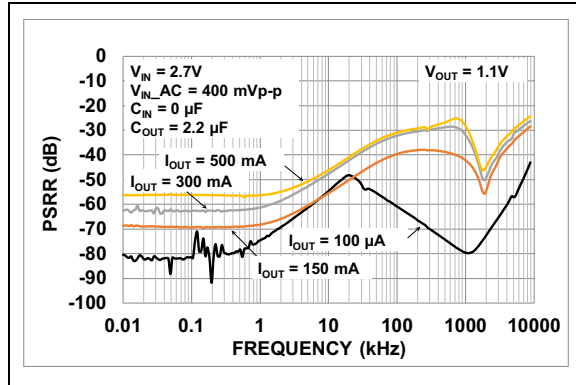

FIGURE 2-16: Power Supply Rejection Ratio.

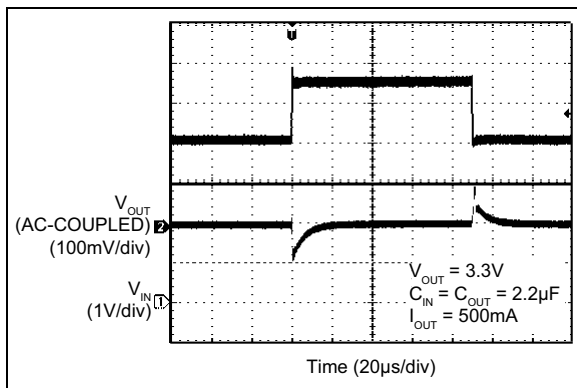

FIGURE 2-14: Line Transient.

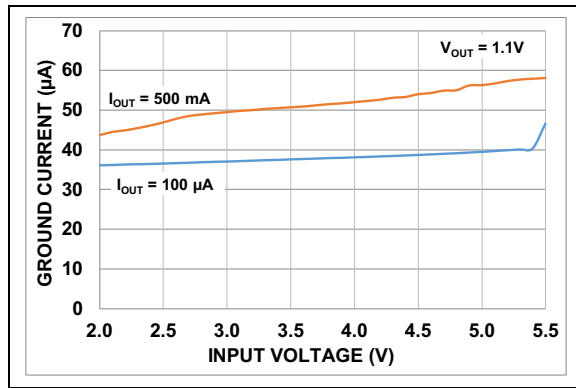

FIGURE 2-17: Ground Current vs. Input Voltage.

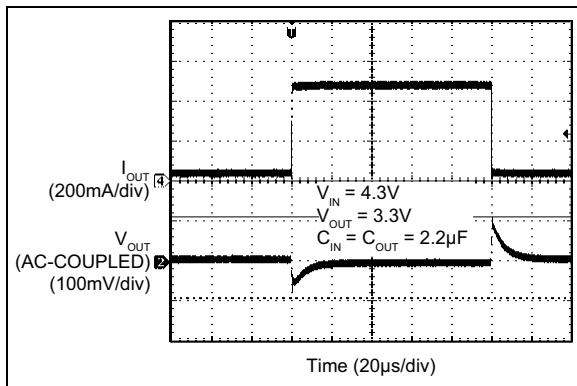

FIGURE 2-15: Load Transient.

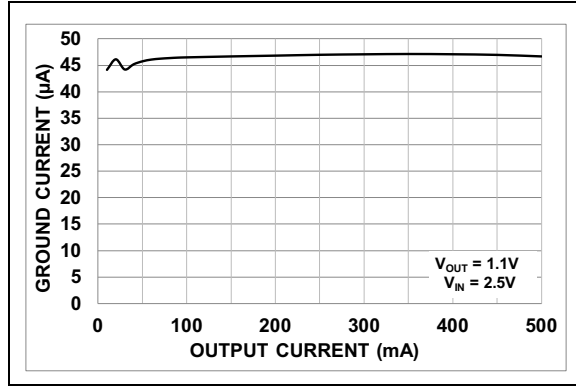

FIGURE 2-18: Ground Current vs. Output Current.

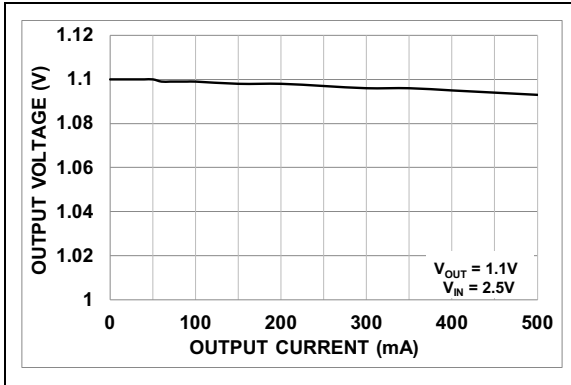

FIGURE 2-19: Output Voltage vs. Output Current.

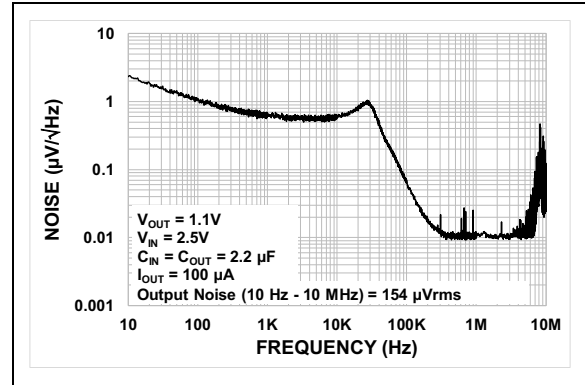

FIGURE 2-22: Output Noise Spectral Density.

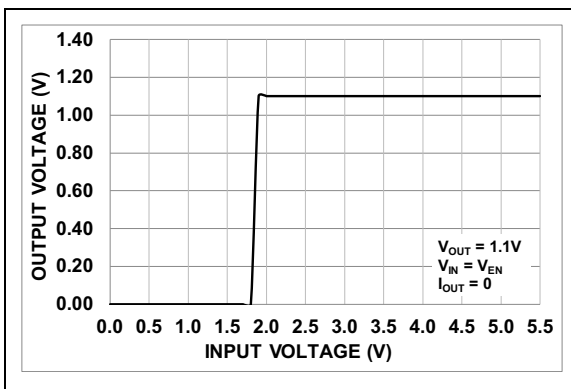

FIGURE 2-20: Output Voltage vs. Input Voltage.

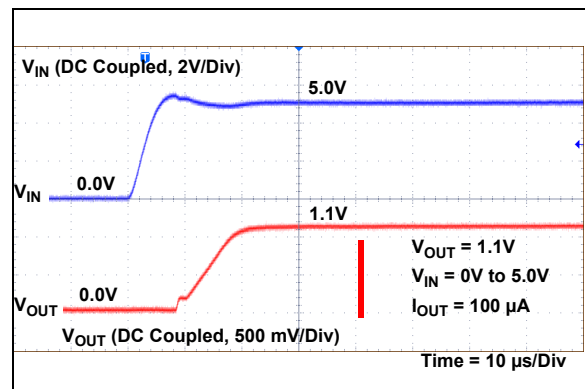

FIGURE 2-23: Start-Up from V_{IN} .

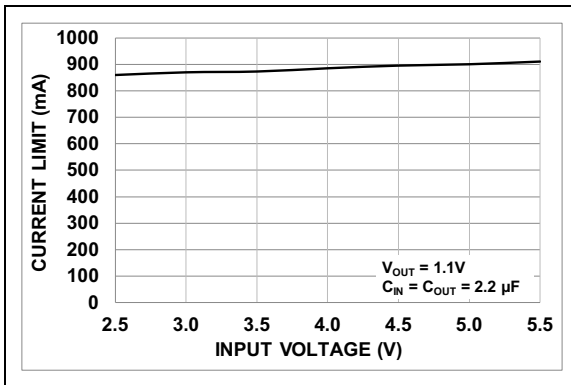

FIGURE 2-21: Current Limit vs. Input Voltage.

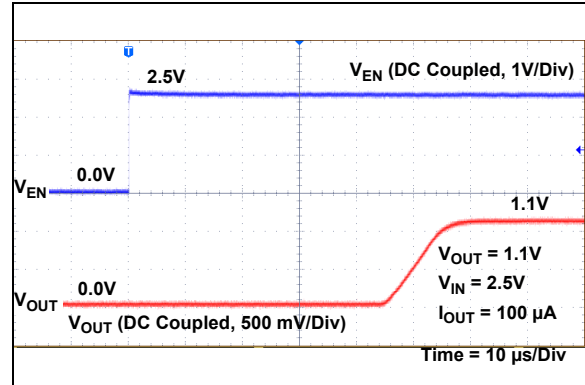

FIGURE 2-24: Start-Up from ENABLE.

MIC5528

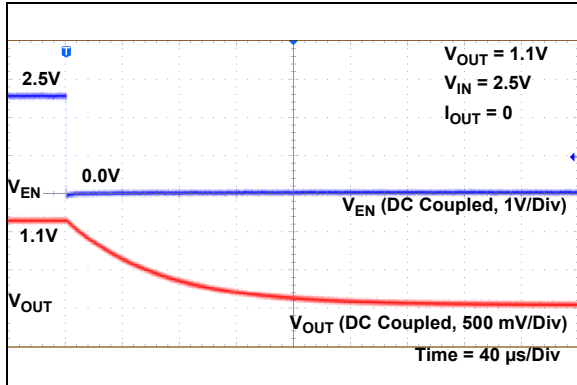

FIGURE 2-25: Auto-Discharge (No Load).

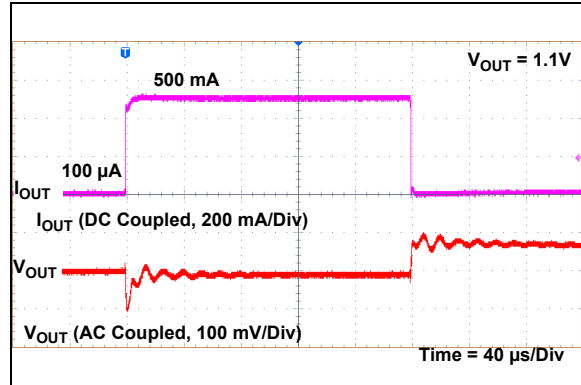

FIGURE 2-28: Load Transient.

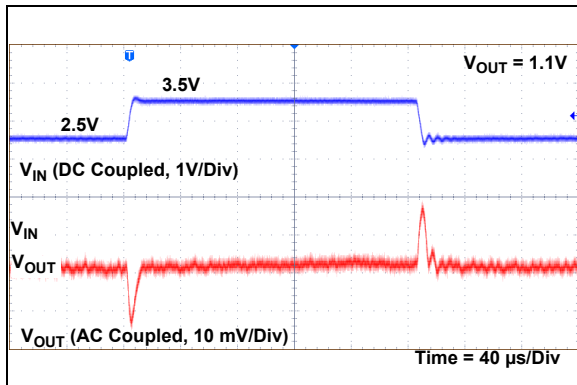

FIGURE 2-26: Line Transient.

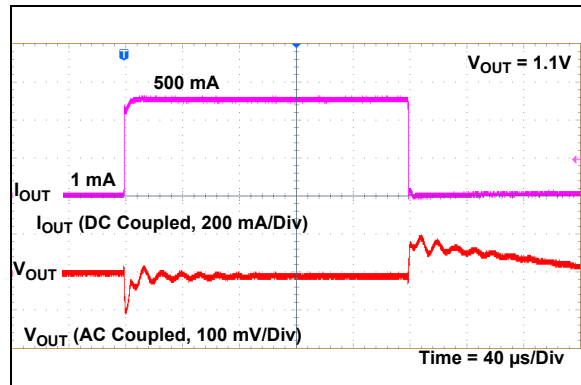

FIGURE 2-29: Load Transient.

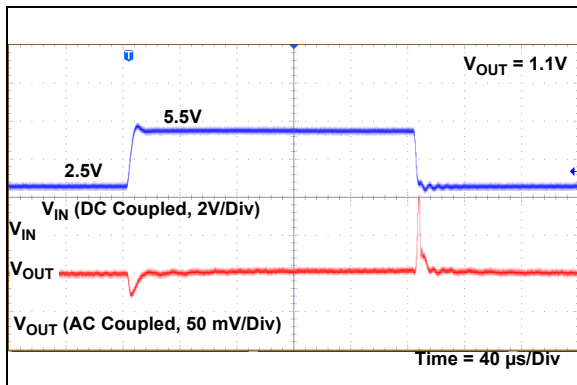

FIGURE 2-27: Line Transient.

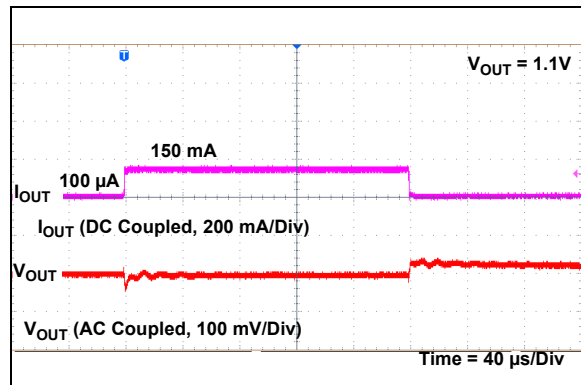

FIGURE 2-30: Load Transient.

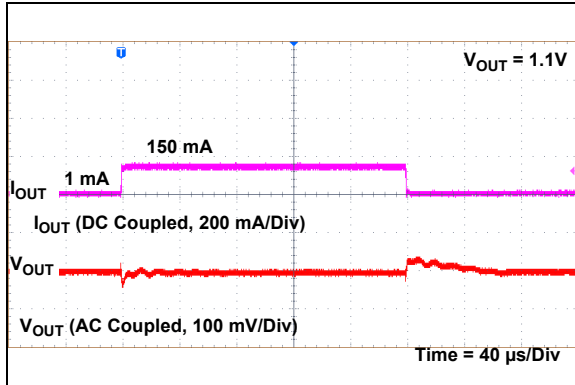

FIGURE 2-31: Load Transient.

MIC5528

3.0 PIN DESCRIPTIONS

The descriptions of the pins are listed in [Table 3-1](#).

TABLE 3-1: PIN FUNCTION TABLE

Pin Number	Pin Name	Description
1, 2	VOUT	Output Voltage. When disabled, the MIC5528 switches in an internal 25Ω load to discharge the external capacitors.
3	GND	Ground.
4	EN	Enable Input: Active-High. High = ON; Low = OFF. The MIC5528 has an internal pull-down and this pin can be left floating.
5	NC	No Connection.
6	VIN	Supply input.
EP	ePad	Exposed Heatsink Pad. Connect to GND for best thermal performance.

4.0 APPLICATION INFORMATION

The MIC5528 is a high performance, low power 500 mA LDO. The MIC5528 includes an auto-discharge circuit that is switched on when the regulator is disabled through the enable pin. The MIC5528 also offers an internal pull-down resistor on the enable pin to ensure the output is disabled if the control signal is tri-stated. The MIC5528 regulator is fully protected from damage due to fault conditions, offering linear current-limiting and thermal shutdown.

4.1 Input Capacitor

The MIC5528 is a high performance, high bandwidth device. An input capacitor of 2.2 μF is required from the input to ground to provide stability. Low-ESR ceramic capacitors provide optimal performance at a minimum of space. Additional high frequency capacitors, such as small-valued NPO dielectric-type capacitors, help filter out high frequency noise and are good practice in any RF-based circuit. X5R or X7R dielectrics are recommended for the input capacitor. Y5V dielectrics lose most of their capacitance over temperature and are therefore, not recommended.

4.2 Output Capacitor

The MIC5528 requires an output capacitor of 2.2 μF or greater to maintain stability. The design is optimized for use with low-ESR ceramic chip capacitors. High-ESR capacitors are not recommended because they may cause high frequency oscillation. The output capacitor can be increased, but performance has been optimized for a 2.2 μF ceramic output capacitor and does not improve significantly with larger capacitance.

X7R/X5R dielectric-type ceramic capacitors are recommended because of their temperature performance. X7R-type capacitors change capacitance by 15% over their operating temperature range and are the most stable type of ceramic capacitors. Z5U and Y5V dielectric capacitors change value by as much as 50% and 60%, respectively, over their operating temperature ranges. To use a ceramic chip capacitor with Y5V dielectric, the value must be much higher than an X7R ceramic capacitor to ensure the same minimum capacitance over the equivalent operating temperature range.

4.3 No-Load Stability

Unlike many other voltage regulators, the MIC5528 remains stable and in regulation with no load. This is especially important in CMOS RAM keep-alive applications.

4.4 Enable/Shutdown

The MIC5528 comes with an active-high enable pin that allows the regulator to be disabled. Forcing the enable pin low disables the regulator and sends it into an off mode current state drawing virtually zero current. When disabled the MIC5528 switches an internal 25 Ω load on the regulator output to discharge the external capacitor.

Forcing the enable pin high enables the output voltage. The MIC5528 has an internal pull-down resistor on the enable pin to disable the output when the enable pin is floating.

4.5 Thermal Considerations

The MIC5528 is designed to provide 500 mA of continuous current in a very small package. Maximum ambient operating temperature can be calculated based on the output current and the voltage drop across the part. For example, if the input voltage is 3.6V, the output voltage is 3.3V, and the output current is 500 mA. The actual power dissipation of the regulator circuit can be determined using [Equation 4-1](#):

EQUATION 4-1:

$$P_D = (V_{IN} - V_{OUT}) \times I_{OUT} + V_{IN} \times I_{GND}$$

Because this device is CMOS and the ground current is typically <100 μA over the load range, the power dissipation contributed by the ground current is <1% and can be ignored [Equation 4-2](#):

EQUATION 4-2:

$$P_D = (3.6V - 3.3V) \times 500mA = 0.150W$$

To determine the maximum ambient operating temperature of the package, use the junction-to-ambient thermal resistance of the device [Equation 4-3](#):

MIC5528

EQUATION 4-3:

$$P_{D(MAX)} = \frac{T_{J(MAX)} - T_A}{\theta_{JA}}$$

Where:

$T_{J(MAX)}$ = 125°C, the maximum junction temperature of the die.

θ_{JA} = Thermal resistance of 173°C/W for the XTDFN.

Substituting P_D for $P_{D(MAX)}$ and solving for the ambient operating temperature will give the maximum operating conditions for the regulator circuit. The junction-to-ambient thermal resistance for the minimum footprint is 173°C/W.

The maximum power dissipation must not be exceeded for proper operation.

For example, when operating the MIC5528-3.3YMX at an input voltage of 3.6V and a 500 mA load with a minimum footprint layout, the maximum ambient operating temperature T_A can be determined as in [Equation 4-4](#):

EQUATION 4-4:

$$0.15 W = (125^\circ C - T_A) / (173^\circ C/W)$$

$$T_A = 99^\circ C$$

Therefore, the maximum ambient operating temperature allowed in a thermally enhanced 1.2 mm × 1.2 mm XTDFN package is 99°C. For a full discussion of heat sinking and thermal effects on voltage regulators, refer to the “Regulator Thermals” section of Microchip’s [Designing with Low-Dropout Voltage Regulators](#) handbook.

5.0 PACKAGING INFORMATION

5.1 Package Marking Information

6-Lead TDFN*

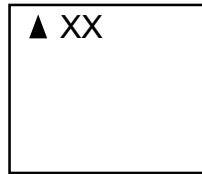

Example

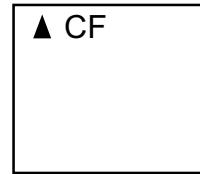

6-Lead XTDFN*

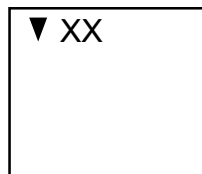

Example

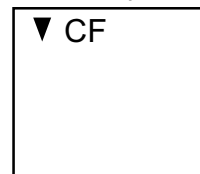

Legend:	XX...X	Product code or customer-specific information
	Y	Year code (last digit of calendar year)
	YY	Year code (last 2 digits of calendar year)
	WW	Week code (week of January 1 is week '01')
	NNN	Alphanumeric traceability code
	(e3)	Pb-free JEDEC® designator for Matte Tin (Sn)
	*	This package is Pb-free. The Pb-free JEDEC designator (e3) can be found on the outer packaging for this package.
	•, ▲, ▼	Pin one index is identified by a dot, delta up, or delta down (triangle mark).
Note:	In the event the full Microchip part number cannot be marked on one line, it will be carried over to the next line, thus limiting the number of available characters for customer-specific information. Package may or may not include the corporate logo.	
	Underbar (_) and/or Overbar (¯) symbol may not be to scale.	

MIC5528

6-Lead Thin DFN 1.2 mm x 1.2 mm Package Outline and Recommended Land Pattern

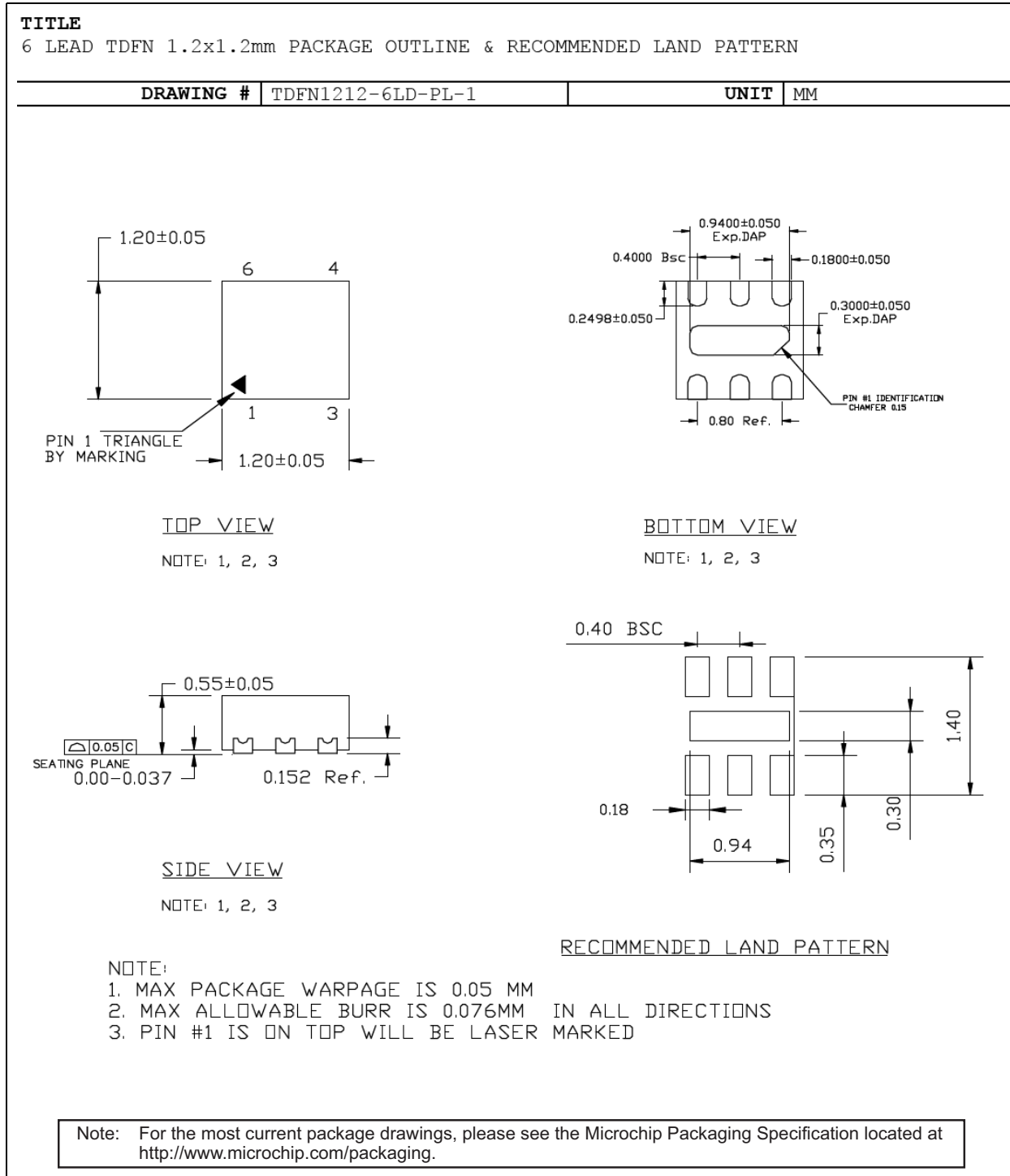

6-Lead Extra Thin DFN 1.2 mm x 1.2 mm Package Outline and Recommended Land Pattern

TITLE

6 LEAD XTDFN 1.2x1.2mm PACKAGE OUTLINE & RECOMMENDED LAND PATTERN

DRAWING #	XTDFN1212-6LD-PL-1	UNIT	MM
Lead Frame	NiPdAu	Lead Finish	NiPdAu

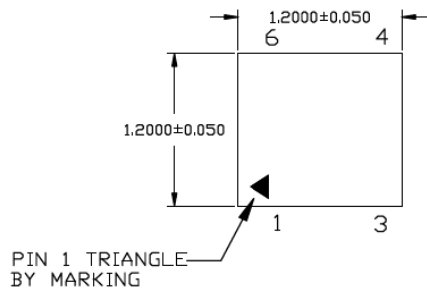

TOP VIEW

NOTE: 1, 2

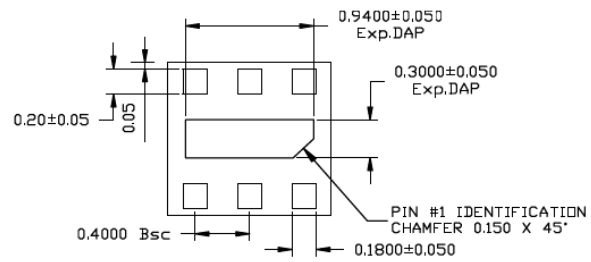

BOTTOM VIEW

NOTE: 1, 2, 3

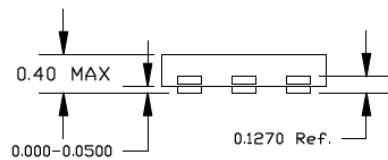

SIDE VIEW

NOTE: 1, 2

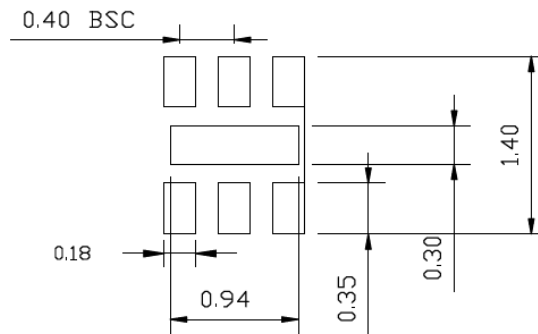

RECOMMENDED LAND PATTERN

NOTE:

1. MAX PACKAGE WARPAGE IS 0.05 MM
2. MAX ALLOWABLE BURR IS 0.076MM IN ALL DIRECTIONS
3. LEAD AND EPAD CORNER MAXIMUM RADIUS 0.075MM

Note: For the most current package drawings, please see the Microchip Packaging Specification located at <http://www.microchip.com/packaging>.

MIC5528

NOTES:

APPENDIX A: REVISION HISTORY

Revision A (March 2018)

- Converted Micrel document MIC5528 to Microchip data sheet DS20005982A.
- Minor text changes throughout.

Revision B (October 2018)

- Updated Output Voltage information in [Features](#).
- Updated Output Voltage information in [Product Identification System](#) section accordingly.

MIC5528

NOTES:

PRODUCT IDENTIFICATION SYSTEM

To order or obtain information, e.g., on pricing or delivery, contact your local Microchip representative or sales office.

Device	-X.X	X	XX	-XX
Part No.	Output Voltage	Junction Temp. Range	Package	Media Type
Device:	MIC5528:	High Performance Single 500 mA μ Cap LDO in Thin and Extra Thin DFN Packages, Featuring Auto Discharge & Internal Enable Pull-Down		
Output Voltage:	1.1 =	1.1V (MX Package only)		
	1.2 =	1.2V (MX Package only)		
	1.8 =	1.8V (MX Package only)		
	2.8 =	2.8V (MX Package only)		
	3.0 =	3.0V (MX Package only)		
	3.3 =	3.3V		
Junction Temperature Range:	Y =	-40°C to +125°C, RoHS-Compliant		
Package:	MT =	6-Lead 1.2 mm x 1.2 mm x 0.6 mm TDFN		
	MX =	6-Lead 1.2 mm x 1.2 mm x 0.4 mm XTDFN		
Media Type:	T5 =	500/Reel		
	TR =	5,000/Reel		
Note:	Other voltage options available. Contact your Microchip Sales Office for more information.			
Examples:	<p>a) MIC5528-1.1YMX-T5: MIC5528, 1.1V Output Voltage, -40°C to +125°C Temperature Range, 6-Lead XTDFN, 500/Reel</p> <p>b) MIC5528-1.2YMX-TR: MIC5528, 1.2V Output Voltage, -40°C to +125°C Temperature Range, 6-Lead XTDFN, 5,000/Reel</p> <p>c) MIC5528-1.8YMX-T5: MIC5528, 1.8V Output Voltage, -40°C to +125°C Temperature Range, 6-Lead XTDFN, 500/Reel</p> <p>d) MIC5528-2.8YMX-TR: MIC5528, 2.8V Output Voltage, -40°C to +125°C Temperature Range, 6-Lead XTDFN, 5,000/Reel</p> <p>e) MIC5528-3.3YMT-T5: MIC5528, 3.3V Output Voltage, -40°C to +125°C Temperature Range, 6-Lead TDFN, 500/Reel</p> <p>f) MIC5528-3.3YMT-TR: MIC5528, 3.3V Output Voltage, -40°C to +125°C Temperature Range, 6-Lead TDFN, 5,000/Reel</p> <p>g) MIC5528-3.0YMX-T5: MIC5528, 3.0V Output Voltage, -40°C to +125°C Temperature Range, 6-Lead XTDFN, 500/Reel</p> <p>h) MIC5528-3.3YMX-TR: MIC5528, 3.3V Output Voltage, -40°C to +125°C Temperature Range, 6-Lead XTDFN, 5,000/Reel</p> <p>Note 1: Tape and Reel identifier only appears in the catalog part number description. This identifier is used for ordering purposes and is not printed on the device package. Check with your Microchip Sales Office for package availability with the Tape and Reel option.</p>			

MIC5528

NOTES:

Note the following details of the code protection feature on Microchip devices:

- Microchip products meet the specification contained in their particular Microchip Data Sheet.
- Microchip believes that its family of products is one of the most secure families of its kind on the market today, when used in the intended manner and under normal conditions.
- There are dishonest and possibly illegal methods used to breach the code protection feature. All of these methods, to our knowledge, require using the Microchip products in a manner outside the operating specifications contained in Microchip's Data Sheets. Most likely, the person doing so is engaged in theft of intellectual property.
- Microchip is willing to work with the customer who is concerned about the integrity of their code.
- Neither Microchip nor any other semiconductor manufacturer can guarantee the security of their code. Code protection does not mean that we are guaranteeing the product as “unbreakable.”

Code protection is constantly evolving. We at Microchip are committed to continuously improving the code protection features of our products. Attempts to break Microchip's code protection feature may be a violation of the Digital Millennium Copyright Act. If such acts allow unauthorized access to your software or other copyrighted work, you may have a right to sue for relief under that Act.

Information contained in this publication regarding device applications and the like is provided only for your convenience and may be superseded by updates. It is your responsibility to ensure that your application meets with your specifications. MICROCHIP MAKES NO REPRESENTATIONS OR WARRANTIES OF ANY KIND WHETHER EXPRESS OR IMPLIED, WRITTEN OR ORAL, STATUTORY OR OTHERWISE, RELATED TO THE INFORMATION, INCLUDING BUT NOT LIMITED TO ITS CONDITION, QUALITY, PERFORMANCE, MERCHANTABILITY OR FITNESS FOR PURPOSE. Microchip disclaims all liability arising from this information and its use. Use of Microchip devices in life support and/or safety applications is entirely at the buyer's risk, and the buyer agrees to defend, indemnify and hold harmless Microchip from any and all damages, claims, suits, or expenses resulting from such use. No licenses are conveyed, implicitly or otherwise, under any Microchip intellectual property rights unless otherwise stated.

Microchip received ISO/TS-16949:2009 certification for its worldwide headquarters, design and wafer fabrication facilities in Chandler and Tempe, Arizona; Gresham, Oregon and design centers in California and India. The Company's quality system processes and procedures are for its PIC® MCUs and dsPIC® DSCs, KEELOQ® code hopping devices, Serial EEPROMs, microperipherals, nonvolatile memory and analog products. In addition, Microchip's quality system for the design and manufacture of development systems is ISO 9001:2000 certified.

**QUALITY MANAGEMENT SYSTEM
CERTIFIED BY DNV
= ISO/TS 16949 =**

Trademarks

The Microchip name and logo, the Microchip logo, AnyRate, AVR, AVR logo, AVR Freaks, BitCloud, chipKIT, chipKIT logo, CryptoMemory, CryptoRF, dsPIC, FlashFlex, flexPWR, Heldo, JukeBlox, KeeLoq, Kleer, LANCheck, LINK MD, maXStylus, maXTouch, MediaLB, megaAVR, MOST, MOST logo, MPLAB, OptoLyzer, PIC, picoPower, PICSTART, PIC32 logo, Prochip Designer, QTouch, SAM-BA, SpyNIC, SST, SST Logo, SuperFlash, tinyAVR, UNI/O, and XMEGA are registered trademarks of Microchip Technology Incorporated in the U.S.A. and other countries.

ClockWorks, The Embedded Control Solutions Company, EtherSynch, Hyper Speed Control, HyperLight Load, IntellIMOS, mTouch, Precision Edge, and Quiet-Wire are registered trademarks of Microchip Technology Incorporated in the U.S.A.

Adjacent Key Suppression, AKS, Analog-for-the-Digital Age, Any Capacitor, AnyIn, AnyOut, BodyCom, CodeGuard, CryptoAuthentication, CryptoAutomotive, CryptoCompanion, CryptoController, dsPICDEM, dsPICDEM.net, Dynamic Average Matching, DAM, ECAN, EtherGREEN, In-Circuit Serial Programming, ICSP, INICnet, Inter-Chip Connectivity, JitterBlocker, KleerNet, KleerNet logo, memBrain, Mindi, MiWi, motorBench, MPASM, MPF, MPLAB Certified logo, MPLIB, MPLINK, MultiTRAK, NetDetach, Omniscient Code Generation, PICDEM, PICDEM.net, PICKit, PICtail, PowerSmart, PureSilicon, QMatrix, REAL ICE, Ripple Blocker, SAM-ICE, Serial Quad I/O, SMART-I.S., SQI, SuperSwitcher, SuperSwitcher II, Total Endurance, TSHARC, USBCheck, VariSense, ViewSpan, WiperLock, Wireless DNA, and ZENA are trademarks of Microchip Technology Incorporated in the U.S.A. and other countries.

SQTP is a service mark of Microchip Technology Incorporated in the U.S.A.

Silicon Storage Technology is a registered trademark of Microchip Technology Inc. in other countries.

GestIC is a registered trademark of Microchip Technology Germany II GmbH & Co. KG, a subsidiary of Microchip Technology Inc., in other countries.

All other trademarks mentioned herein are property of their respective companies.

© 2018, Microchip Technology Incorporated, All Rights Reserved.
ISBN: 978-1-5224-3786-4



MICROCHIP

Worldwide Sales and Service

AMERICAS

Corporate Office
2355 West Chandler Blvd.
Chandler, AZ 85224-6199
Tel: 480-792-7200
Fax: 480-792-7277
Technical Support:
<http://www.microchip.com/support>
Web Address:
www.microchip.com

Atlanta

Duluth, GA
Tel: 678-957-9614
Fax: 678-957-1455

Austin, TX

Tel: 512-257-3370

Boston

Westborough, MA
Tel: 774-760-0087
Fax: 774-760-0088

Chicago

Itasca, IL
Tel: 630-285-0071
Fax: 630-285-0075

Dallas

Addison, TX
Tel: 972-818-7423
Fax: 972-818-2924

Detroit

Novi, MI
Tel: 248-848-4000

Houston, TX

Tel: 281-894-5983

Indianapolis

Noblesville, IN
Tel: 317-773-8323
Fax: 317-773-5453
Tel: 317-536-2380

Los Angeles

Mission Viejo, CA
Tel: 949-462-9523
Fax: 949-462-9608
Tel: 951-273-7800

Raleigh, NC

Tel: 919-844-7510

New York, NY

Tel: 631-435-6000

San Jose, CA

Tel: 408-735-9110
Tel: 408-436-4270

Canada - Toronto

Tel: 905-695-1980
Fax: 905-695-2078

ASIA/PACIFIC

Australia - Sydney
Tel: 61-2-9868-6733

China - Beijing
Tel: 86-10-8569-7000

China - Chengdu
Tel: 86-28-8665-5511

China - Chongqing
Tel: 86-23-8980-9588

China - Dongguan
Tel: 86-769-8702-9880

China - Guangzhou
Tel: 86-20-8755-8029

China - Hangzhou
Tel: 86-571-8792-8115

China - Hong Kong SAR
Tel: 852-2943-5100

China - Nanjing
Tel: 86-25-8473-2460

China - Qingdao
Tel: 86-532-8502-7355

China - Shanghai
Tel: 86-21-3326-8000

China - Shenyang
Tel: 86-24-2334-2829

China - Shenzhen
Tel: 86-755-8864-2200

China - Suzhou
Tel: 86-186-6233-1526

China - Wuhan
Tel: 86-27-5980-5300

China - Xian
Tel: 86-29-8833-7252

China - Xiamen
Tel: 86-592-2388138

China - Zhuhai
Tel: 86-756-3210040

ASIA/PACIFIC

India - Bangalore
Tel: 91-80-3090-4444

India - New Delhi
Tel: 91-11-4160-8631

India - Pune
Tel: 91-20-4121-0141

Japan - Osaka
Tel: 81-6-6152-7160

Japan - Tokyo
Tel: 81-3-6880-3770

Korea - Daegu
Tel: 82-53-744-4301

Korea - Seoul
Tel: 82-2-554-7200

Malaysia - Kuala Lumpur
Tel: 60-3-7651-7906

Malaysia - Penang
Tel: 60-4-227-8870

Philippines - Manila
Tel: 63-2-634-9065

Singapore
Tel: 65-6334-8870

Taiwan - Hsin Chu
Tel: 886-3-577-8366

Taiwan - Kaohsiung
Tel: 886-7-213-7830

Taiwan - Taipei
Tel: 886-2-2508-8600

Thailand - Bangkok
Tel: 66-2-694-1351

Vietnam - Ho Chi Minh
Tel: 84-28-5448-2100

EUROPE

Austria - Wels
Tel: 43-7242-2244-39
Fax: 43-7242-2244-393

Denmark - Copenhagen
Tel: 45-4450-2828
Fax: 45-4485-2829

Finland - Espoo
Tel: 358-9-4520-820

France - Paris
Tel: 33-1-69-53-63-20
Fax: 33-1-69-30-90-79

Germany - Garching
Tel: 49-8931-9700

Germany - Haan
Tel: 49-2129-3766400

Germany - Heilbronn
Tel: 49-7131-67-3636

Germany - Karlsruhe
Tel: 49-721-625370

Germany - Munich
Tel: 49-89-627-144-0
Fax: 49-89-627-144-44

Germany - Rosenheim
Tel: 49-8031-354-560

Israel - Ra'anana
Tel: 972-9-744-7705

Italy - Milan
Tel: 39-0331-742611
Fax: 39-0331-466781

Italy - Padova
Tel: 39-049-7625286

Netherlands - Drunen
Tel: 31-416-690399
Fax: 31-416-690340

Norway - Trondheim
Tel: 47-7288-4388

Poland - Warsaw
Tel: 48-22-3325737

Romania - Bucharest
Tel: 40-21-407-87-50

Spain - Madrid
Tel: 34-91-708-08-90
Fax: 34-91-708-08-91

Sweden - Gothenberg
Tel: 46-31-704-60-40

Sweden - Stockholm
Tel: 46-8-5090-4654

UK - Wokingham
Tel: 44-118-921-5800
Fax: 44-118-921-5820