

10Gb/s DWDM EA Modulator and DFB Laser with GPO RF Connector

EML10WCA

The Bookham EML10 Laser has an electro-absorption modulator monolithically integrated with a conventional Distributed Feedback Multi Quantum Well (MQW) laser. This allows the modulation voltage to be applied to the modulator section whilst the laser section operates CW allowing extremely low wavelength chirping. Specifically designed for use in STM-64/OC-192 DWDM 100GHz applications over 40km, with low dispersion penalty at 9.953Gb/s, (<2dB). A high extinction ratio of >10.5dB. This device is available in a hermetic 7-pin ceramic butterfly package with SMP/GPO connector for modulation input. The EML10 includes an optical isolator, monitor photodiode, thermistor and thermo-electric cooler.

Features:

- High output power
- Low modulation voltage
- Long haul performance with negligible dispersion penalty
- Single 50Ω low voltage drive modulation input
- Integral thermo-electric cooler with precision NTC temperature control
- Hermetically sealed 7-pin butterfly package with optical isolator
- High stability laser chip
- No wavelength locker required
- High extinction ratio >10.5dB
- RoHS compliant 

Applications:

- Suitable for use:
- In DWDM FEC applications (~ 10.709Gb/s)
- In DWDM applications (~ 9.95Gb/s)
- ITU-T standard 100GHz grid
- C band (1529.55nm to 1560.61nm)
- With MetroCor™ and standard SMF-28™ fiber 40km applications

MetroCor™ and SMF-28™ are registered trademarks of Corning Incorporated

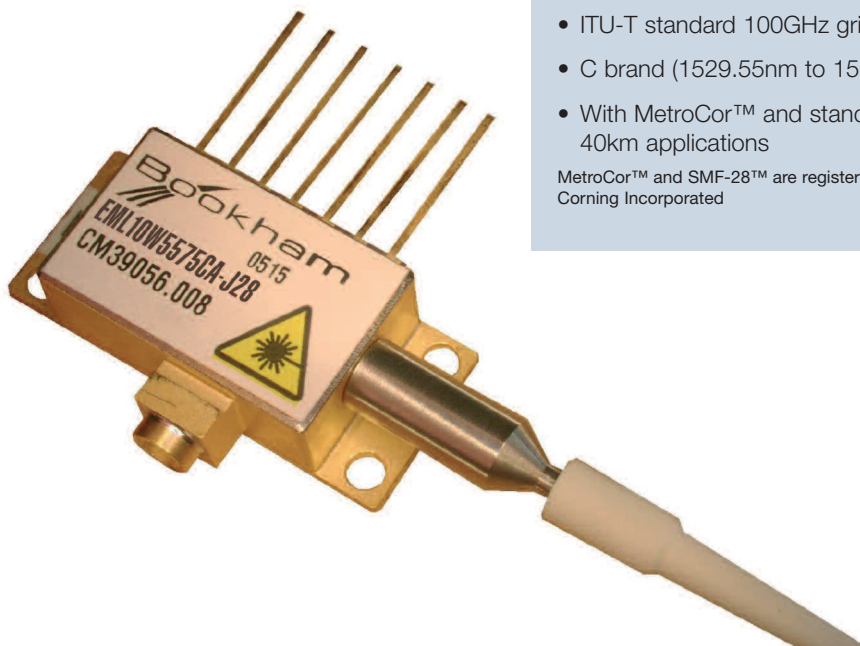

Characteristics

T_{case} = 25°C, T_{laser} = 25°C unless otherwise stated

Parameter	Conditions	Min	Typ	Max	Unit
CW Laser					
Threshold current		5	20	35	mA
Threshold power			0.001	1	uW
Operating current SOL	@I _{op}	50	80	90	mA
Operating current EOL	@I _{op}			100	mA
Laser forward voltage	I _f =80mA @ 25°C, CW	1.0	1.2	2	V
Peak wavelength		1529.55		1560.61	nm
Wavelength drift vs life time	15 years typical life	-100		100	pm
Wavelength stability with case temperatures		-0.5		+0.5	pm/°C
Side mode suppression ratio (SMSR) @ I _{op}		36	45		dB
Spectral width @ I _{op}	-20dB, Notes [2] [1]	0.2	0.27	0.3	nm
Optical Modulator					
Modulator drive voltage		2	2.5	2.8	V _{pp}
Bias voltage for 'on' level		-0.7	-0.25	0	V
Fiber output power	Note [1]	-3	-2	-1	dBm
Case temperature tracking error	T _{case} = -20 to +70 °C @ cont I _m	-0.5	+/-0.1	0.5	dB
S21 Optical bandwidth	VEA @-1V	9	12.5		GHz
S11 return loss (0 GHz to 7 GHz)	VEA @-1V		-15	-8	dB
S11 return loss (7 GHz to 10 GHz)	VEA @-1V		-10	-5	
Optical rise/fall time	20 to 80%, Notes [1] [3]	20	36	40	ps
Dynamic optical extinction ratio	Notes [1] [3]	10.5	11		dB
OC192/SDH64 mask margin	Notes [1] [3]	10	18		%
Dispersion penalty (RX power penalty)	Notes [1] [4]		1	2	dB

Characteristics (continued)

Parameter	Conditions	Min	Typ	Max	Unit
Photodiode Monitor					
Monitor diode bias voltage		1.0	5	10	V
Monitor diode current	Note _[1] , @I _{op}	0.2	0.5	1.5	mA
Dark current			0.001	0.1	uA
Capacitance				15	pF
Thermo Electric Cooler System					
Thermistor resistance @ Tsub=25degC		9.5	10	10.5	kW
Thermistor Steinhart-Hart coefficient C1			1.03E-03		
Thermistor Steinhart-Hart coefficient C2			2.39E-04		
Thermistor Steinhart-Hart coefficient C3			1.56E-07		
Thermistor B constant	0/50k	3539	3575	3611	
Thermistor current		1	10	100	uA
Laser submount temperature		20	25	35	°C
TEC current (EOL)				1.3	A
TEC voltage (EOL)				2.5	V
TEC power dissipation				3.3	W
Other					
Optical isolation	Tcase = -20 to +70 °C	25	30		dB
Fiber Length		0.8		1.2	m

Notes:

- [1] Applied modulation is 9.953Gb/s, 2²³-1 PRBS NRZ data sequence.
- [2] Linewidth is measured using 0.06nm resolution bandwidth.
- [3] Optical eye parameters measured with a Communications Analyser with Agilent plug-in module 86106B option 410 (or equivalent). Optical 0/1 crossing typically 50%.
- [4] Fiber characteristics are derived from the following equation;

$$D(\lambda) = \frac{S_0}{4} \left(\lambda - \frac{\lambda_0^4}{\lambda^3} \right) ps/(nm^2.km)$$

Where S₀ = 0.092 ps/(nm².km) and λ₀ = 1302nm. Receiver sensitivity measured at a BER of 1e-10. RX OSNR > 35dB, optimised RX CDR phase adjust and 50% CDR slice level.

Absolute Maximum Ratings

Tcase = 25°C unless otherwise stated

The table below provides maximum and/or minimum values of critical parameters which will not permanently damage the device, but for which the operating specification may not hold.

Parameter	Conditions	Min	Typ	Max	Unit
Operating temperature		-20		70	°C
Storage temperature		-40		85	°C
Lead soldering time	T=260°C			10	s
Fiber bend radius		20			mm
Axial force on fiber				5	N
Laser forward current	CW @ 30C			150	mA
Laser reverse voltage				2	V
Modulator forward voltage				1	V
Modulator reverse voltage		-5		1	V
Monitor diode reverse voltage				20	V
Photodiode forward current				1	mA
TEC voltage				2.5	V
TEC current				1.4	A
ESD	Note [5]	500			V

Note:

[5] In accordance with Telcordia TR-NWT-000870, ESD class 3, human body model.

Optical Systems Performance

Optical Eye Diagram

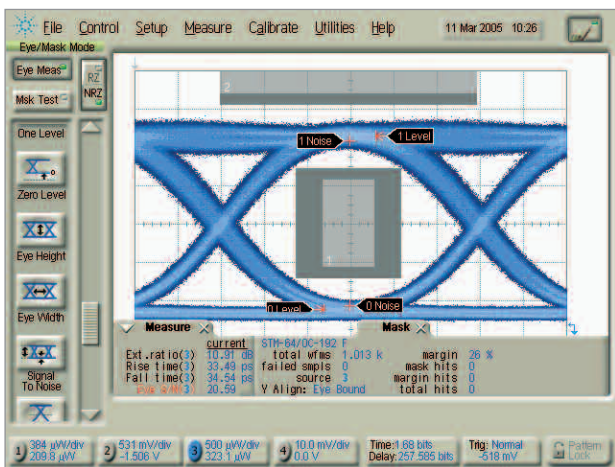

Test conditions: 9.953Gb/s 2²³-1 PRBS NRZ data.

Dispersion Penalty Plots

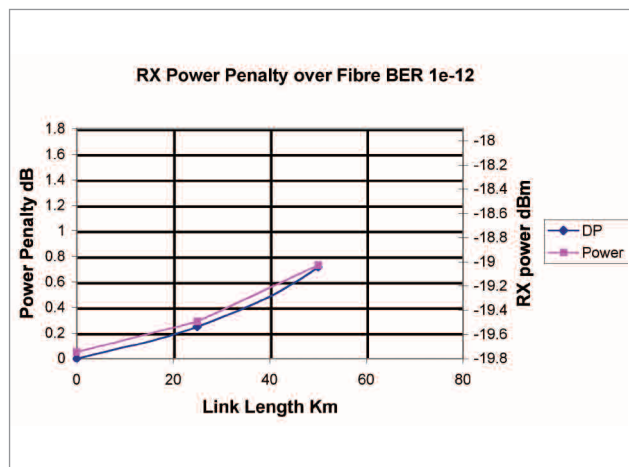

Test conditions: 9.953Gb/s 2²³-1 PRBS NRZ data.

Applications Support

The following documents are available to support customers using this product:

Document Title	Document Reference
Performance Comparison of commercially available RF drivers for the Bookham EML11.	AN0140

Optical component evaluation platforms are available for all Bookham optical components. Contact your regional sales representative for further information.

Outline Drawing

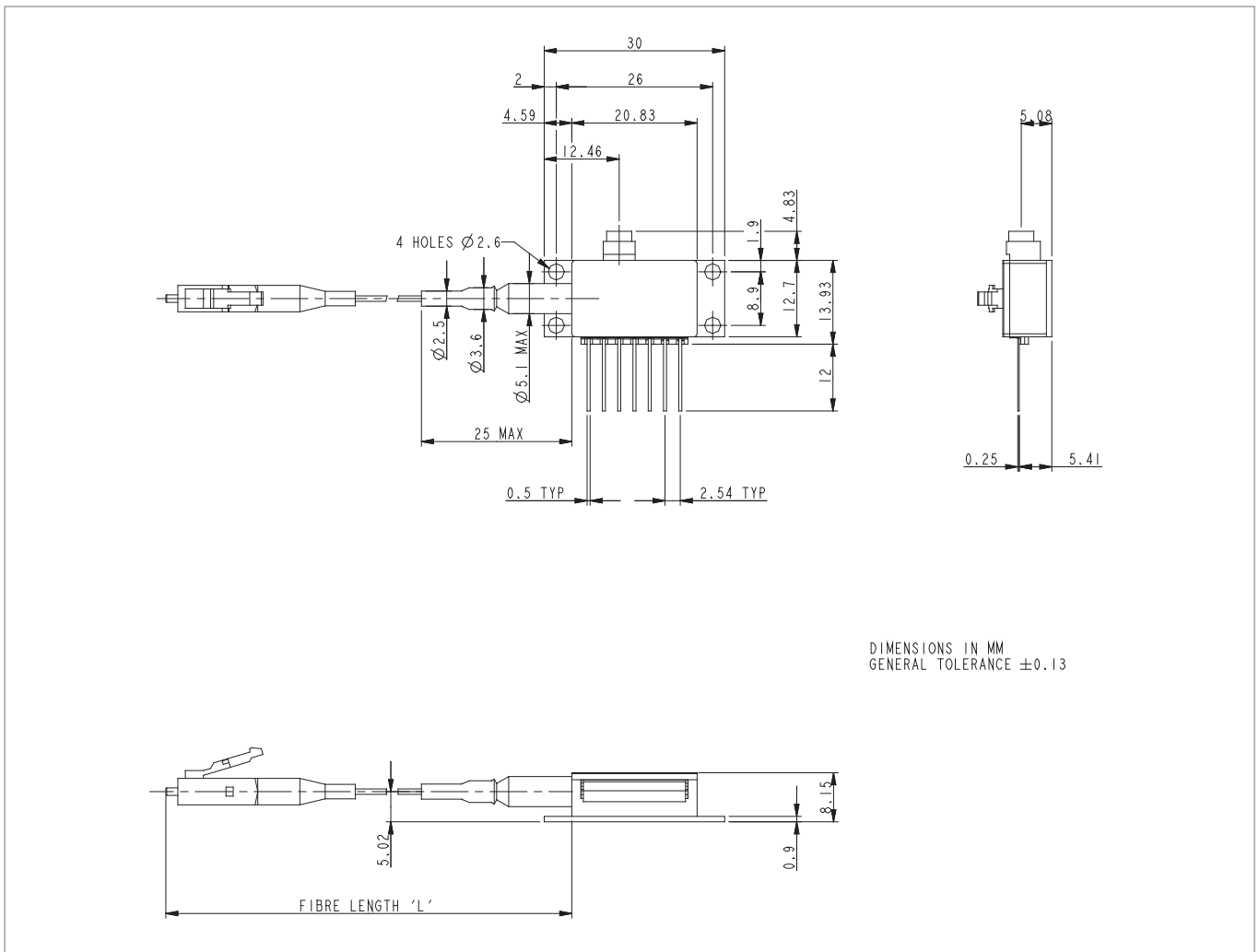

Connections

Pin #		Pin #	
1	Thermistor	5	BFM Cathode
2	Thermistor	6	Cooler (+)
3	Laser bias (+) Anode	7	Cooler (-)
4	BFM Anode		

Note:

Laser cathode is case ground. SMP/GPO center is EA modulation(-).
Pin 1 is nearest the fiber tail.

Deliverable Data

The following data file is provided using an Electronic Data Exchange (EDE) process, a paper copy will also be provided with each module.

(Tlaser = 25°C, Tcase = 25°C unless otherwise specified)

Parameter	Symbol	Condition	Format	Unit
On Level Modulation	V_O		Value	V
Modulator Drive Voltage (pk-pk)	V_{MOD}		Value	V
CW Laser Threshold Current	I_{TH}	CW, $V_{MOD}=V_O$	Value	mA
CW Laser Operating Current	I_{OP}	CW	Value	mA
Monitor Photocurrent	I_M	Note [6]	Value	mA
Peak Wavelength	L_{PK}	Note [6]	Value	nm
Mean Modulated Output Power	P_O	Note [6]	Value	dBm
Thermistor Resistance			Value	Ω

Note:

[6] Bookham Test Conditions, 9.953Gb/s, 2^23-1 PRBS NRZ DATA.

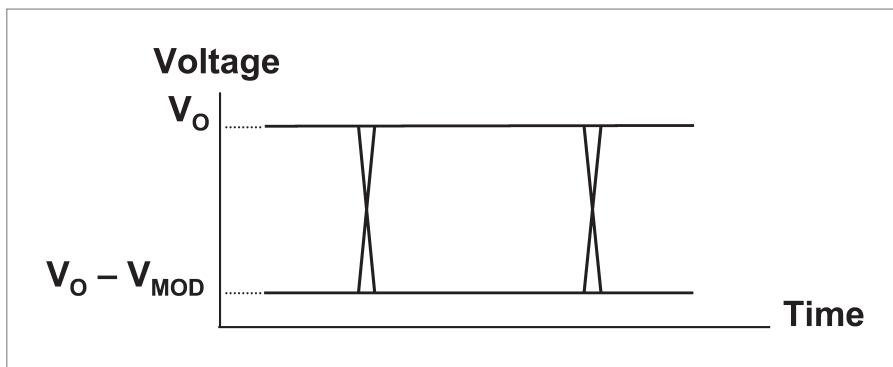

Reliability

Bookham has a corporate policy for continuous improvement, to provide optical components with superior quality in terms of opto-electronic performance and operational life and reliability. The Bookham EML10 and EML11 Integrated Electro-absorption laser products use a ridge waveguide structure for the laser and modulator, which provides superior reliability compared to buried heterostructures. It has been subjected to a stringent reliability assurance program, the conclusions of which confirm product reliability exceed the generic requirements of Telcordia GR-468 CORE.

More than 965,000 device-hours of data under accelerated life test conditions have been analysed, which for the purpose of characterising random failure rate, is equivalent to 28,300,000 device hours at 25°C operating temperature [7]. Electro-optic parameters for a 15 year service life at operating temperature of 25°C have been estimated. The estimated delta over life for specific device parameters is shown in the table below.

Parameter	Maximum allowed change	Change over 15 years @ 25 °C Mean (std. deviation)
EA - Extinction rate ER	0.5 dB	-0.03 dB (0.2 dB)
Laser threshold current	10 %	0.01 % (0.3 %)
Laser efficiency	10 %	-0.2 % (0.4 %)
Laser current for constant output power	10 %	0.2 % (0.4 %)
Laser power at constant current (100 mA)	10 %	-0.2 % (0.4 %)

The reliability failure rate statistics are summarized in the table below. The results are reported for the operation of the device against a laser bias of 100 mA drive current. The resultant low MTTF [8], essentially demonstrating minimal component wear out over the rated 15-year lifetime of the component [7].

Parameter	Value	Units
Median life (ML) at 25°C	528 ⁽¹⁾	Years
σ (standard deviation of the natural logarithms of the TTFs)	0.64	
μ (mean of the natural logarithms of the TTFs)	6.27	
Maximum wear-out failure rate	0	FITs
Average wear-out failure rate over 15 years life	0	FITs
Wear-out thermal activation energy	0.5	eV
Random failure rate at 25°C at 60% confidence	33	FITs
Random failure rate activation energy	0.35	eV

Notes:

[7] Refer to QR1524, qualification report for the Bookham 10Gb/s Electro-Absorption Modulated Laser.

[8] Bookham Technology's policy is to derive random failure rates from actual field data.

Example

EML10W5575CA-J28 is a 1555.747nm EA laser with GPO RF connector and SC/PC fiber connector for 40km reach applications.

Wavelength Code	Wavelength (nm)	ITU-T Frequency (THz)	Tolerance (nm)
2955	1529.553	196.0	+/-0.1
3033	1530.334	195.9	+/-0.1
3112	1531.116	195.8	+/-0.1
3190	1531.898	195.7	+/-0.1
3268	1532.681	195.6	+/-0.1
3347	1533.465	195.5	+/-0.1
3425	1534.250	195.4	+/-0.1
3504	1535.036	195.3	+/-0.1
3582	1535.822	195.2	+/-0.1
3661	1536.609	195.1	+/-0.1
3740	1537.397	195.0	+/-0.1
3819	1538.186	194.9	+/-0.1
3898	1538.976	194.8	+/-0.1
3977	1539.766	194.7	+/-0.1
4056	1540.557	194.6	+/-0.1
4135	1541.349	194.5	+/-0.1
4214	1542.142	194.4	+/-0.1
4294	1542.936	194.3	+/-0.1
4373	1543.730	194.2	+/-0.1
4453	1544.526	194.1	+/-0.1

Wavelength Code	Wavelength (nm)	ITU-T Frequency (THz)	Tolerance (nm)
4532	1545.322	194.0	+/-0.1
4612	1546.119	193.9	+/-0.1
4692	1546.917	193.8	+/-0.1
4772	1547.715	193.7	+/-0.1
4851	1548.515	193.6	+/-0.1
4932	1549.315	193.5	+/-0.1
5012	1550.116	193.4	+/-0.1
5092	1550.918	193.3	+/-0.1
5172	1551.721	193.2	+/-0.1
5252	1552.524	193.1	+/-0.1
5333	1553.329	193.0	+/-0.1
5413	1554.134	192.9	+/-0.1
5494	1554.940	192.8	+/-0.1
5575	1555.747	192.7	+/-0.1
5655	1556.555	192.6	+/-0.1
5736	1557.363	192.5	+/-0.1
5817	1558.173	192.4	+/-0.1
5898	1558.983	192.3	+/-0.1
5979	1559.794	192.2	+/-0.1
6061	1560.606	192.1	+/-0.1

RoHS Compliance



Bookham is fully committed to environment protection and sustainable development and has set in place a comprehensive program for removing polluting and hazardous substances from all of its products. The relevant evidence of RoHS compliance is held as part of our controlled documentation for each of our compliant products. RoHS compliance parts are available to order, please refer to the ordering information section for further details.

Ordering Information:

EML10W****CA - [Connector Type]
J28 = SC/PC
J34 = FC/PC
J57 = LC
J59 = MU

Example

EML10W5575CA-J28 is a 1555.747nm EA laser with GPO RF connector with SC/PC fiber connector for 40km reach applications.

Contact Information

North America Bookham Worldwide Headquarters

2584 Junction Ave.
 San Jose
 CA 95134
 USA

- Tel: +1 408 919 1500
- Fax: +1 408 919 6083

www.bookham.com
sales@bookham.com

Europe Paignton Office

Brixham Road
 Paignton
 Devon
 TQ4 7BE
 United Kingdom

- Tel: +44 (0) 1803 66 2000
- Fax: +44 (0) 1803 66 2801

Asia Shenzhen Office

2 Phoenix Road
 Futian Free Trade Zone
 Shenzhen 518038
 China

- Tel: +86 755 33305888
- Fax: +86 755 33305805
 +86 755 33305807

Important Notice

Performance figures, data and any illustrative material provided in this data sheet are typical and must be specifically confirmed in writing by Bookham before they become applicable to any particular order or contract. In accordance with the Bookham policy of continuous improvement specifications may change without notice. The publication of information in this data sheet does not imply freedom from patent or other protective rights of Bookham or others. Further details are available from any Bookham sales representative.

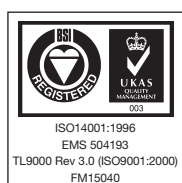

Caution - use of controls or adjustments or performance of procedures other than those specified herein may result in hazardous radiation exposure.