



DESCRIPTION

The A6151 series is a set of three-terminal middle current low voltage regulator implemented in CMOS technology. They can deliver 100mA output current and allow an input voltage as high as 18V. They are available with several fixed output voltages ranging from 3.0V to 8.0V. CMOS technology ensures low voltage drop and low quiescent current.

A6151 is available in SOT89-3 package.

FEATURES

- Low power: 2uA (typ.)
- Low voltage drop: 100mV @ $I_{OUT}=1mA$
- Low temperature coefficient : $< \pm 100ppm/^{\circ}C$
- High input voltage : 18V
- Maximum output current : 100mA
- Available in SOT89-3 Packages

APPLICATION

- Battery-powered equipment
- Communication equipment
- Audio/Video equipment

ORDERING INFORMATION

Package Type	Part Number	
SOT89-3 SPQ: 1,000pcs/Reel	K3	A6151K3R-XX
		A6151K3VR-XX
Note	XX: Output Voltage, 28=2.8V, 36=3.6V, 40=4.0V V: Halogen free Package R: Tape & Reel	
AiT provides all RoHS products		

TYPICAL APPLICATION

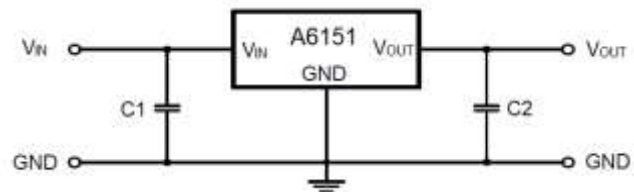

Note: $C_{IN}(C1) \geq 10\mu F$; $C_{OUT}(C2) \geq 10\mu F$.



PIN DESCRIPTION

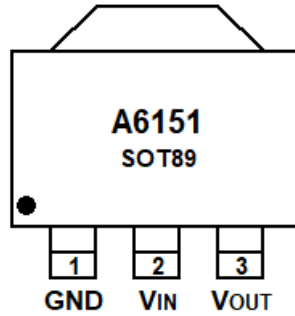

Top View

Pin #	Symbol	Function
1	GND	Ground
2	V _{IN}	Power Input
3	V _{OUT}	Output



ABSOLUTE MAXIMUM RATINGS

V_{IN} , Input Voltage	-0.3V~18V	
P_D , Power Dissipation	SOT89-3	500mW
T_{OPR} , Operating Ambient Temperature	-40°C ~ +85°C	
T_{STG} , Storage Temperature	-40°C ~ +125°C	

Stresses above may cause permanent damage to the device. These are stress ratings only, and functional operation of the device at these or any other conditions beyond those indicated in the Electrical Characteristics is not implied. Exposure to absolute maximum rating conditions for extended periods may affect device reliability.

ELECTRICAL CHARACTERISTICS

$T_A=25^\circ\text{C}$

Parameter	Symbol	Test Conditions		Min.	Typ.	Max.	Unit
		V_{IN}	Conditions				
Output Voltage Tolerance	V_{OUT}	$V_{OUT}+2V$	$I_{OUT}=10\text{mA}$	$0.98 \times V_{OUT}$	V_{OUT}	$1.02 \times V_{OUT}$	V
Output Current	I_{OUT}	$V_{OUT}+2V$		60	100	120	mA
Load Regulation	ΔV_{OUT}	$V_{OUT}+2V$	$1\text{mA} \leq I_{OUT} \leq 50\text{mA}$	-	60	150	mV
Voltage Drop	V_{DROP}		$I_{OUT}=1\text{mA}$	-	100	-	mV
Current Consumption	I_{SS}	$V_{OUT}+2V$	No Load	-	2	4	μA
Output Shorted Current	I_{SHORT}	$V_{OUT}+2V$	V_{OUT} Connected to ground	20	-	80	mA
Line Regulation	$\frac{\Delta V_{OUT}}{\Delta V_{IN} \times V_{OUT}}$		$V_{OUT}+2V \leq V_{IN} \leq 18$ $I_{OUT}=1\text{mA}$	-	0.2	-	%/V
Input Voltage	V_{IN}			-	-	18	V
Temperature Coefficient	$\frac{\Delta V_{OUT}}{\Delta T_A}$	$V_{OUT}+2V$	$I_{OUT}=10\text{mA}$ $-40^\circ\text{C} \leq T_A \leq 85^\circ\text{C}$	-	$\pm 0.45 \times \frac{V_{OUT}}{3}$	-	$\frac{\text{mV}}{^\circ\text{C}}$
Power Supply Ripple Rejection Rate	PSRR		$f=1.0\text{kHz}$	-	-	40	dB



TYPICAL PERFORMANCE CHARACTERISTICS

1. Quiescent Current vs. Input Voltage

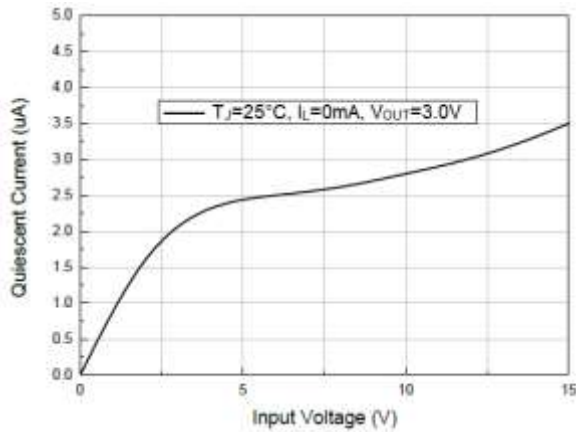

2. Reverse Output Current vs. Output Voltage

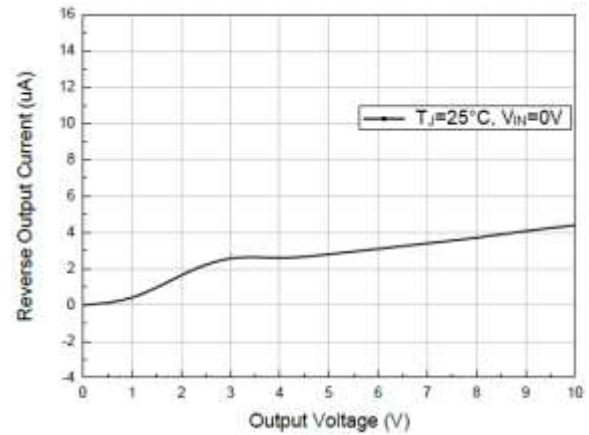

3. Current Limit vs. $V_{IN}-V_{OUT}$

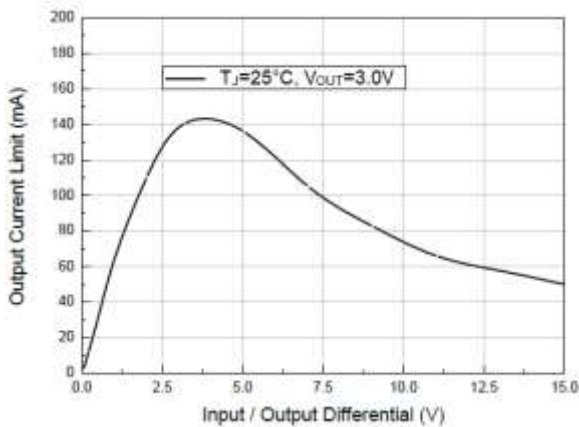

4. GND Pin Current vs. Output Current

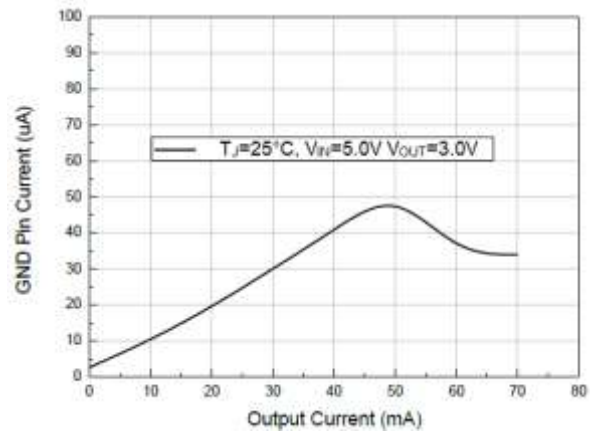

5. GND Pin Current vs. Input Voltage

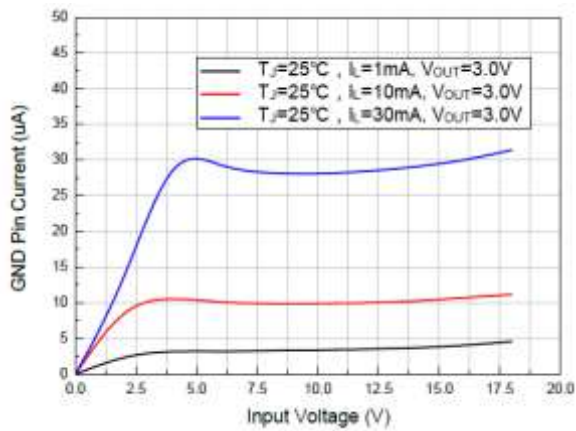

6. Dropout Voltage vs. Temperature

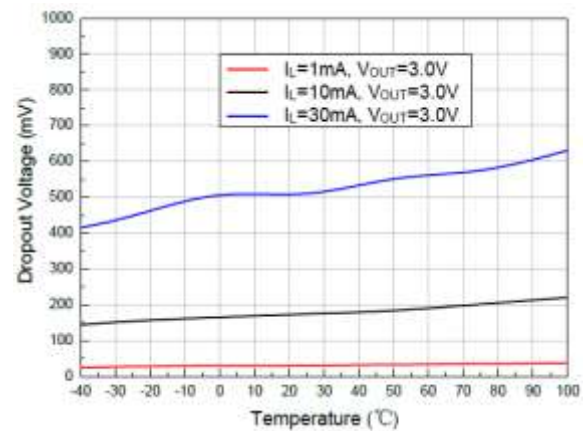



7. Quiescent Current vs. Temperature

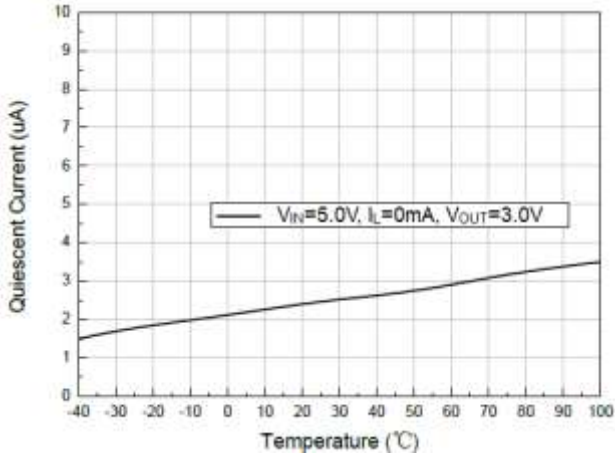

8. Output Voltage vs. Temperature

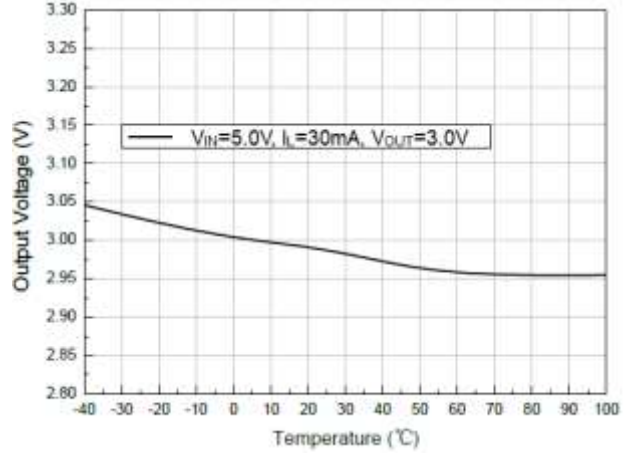

9. Output Current vs. Temperature

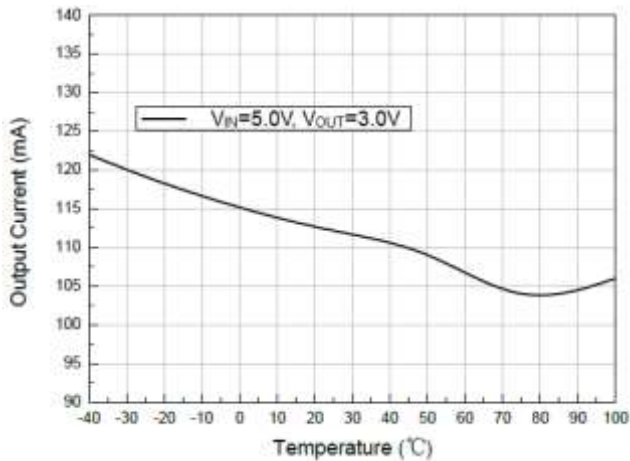

10. Reverse Output Current vs. Temperature

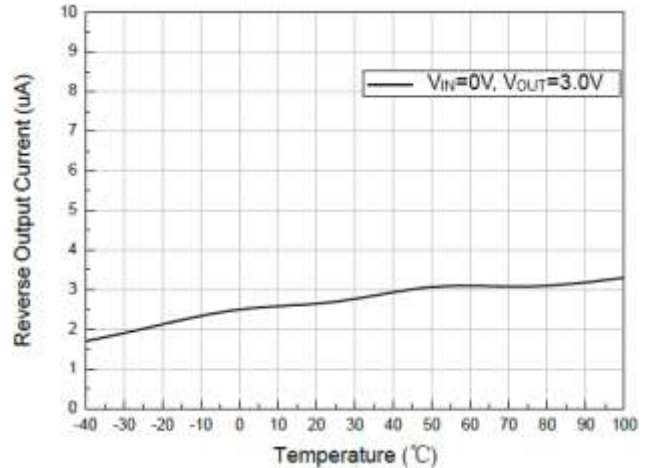

11. Minimum Input Voltage vs. Temperature

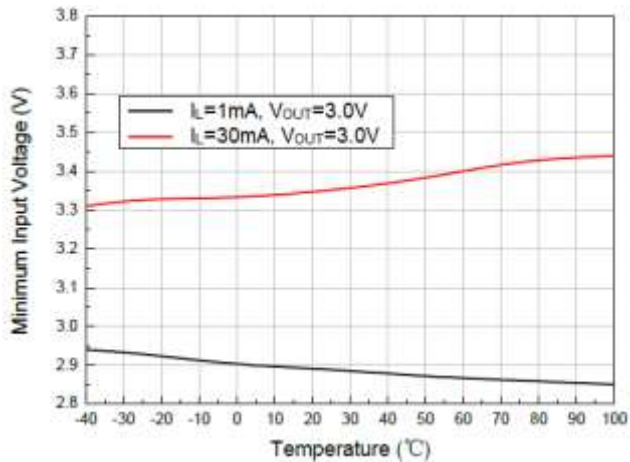

12. Load Regulation vs. Temperature

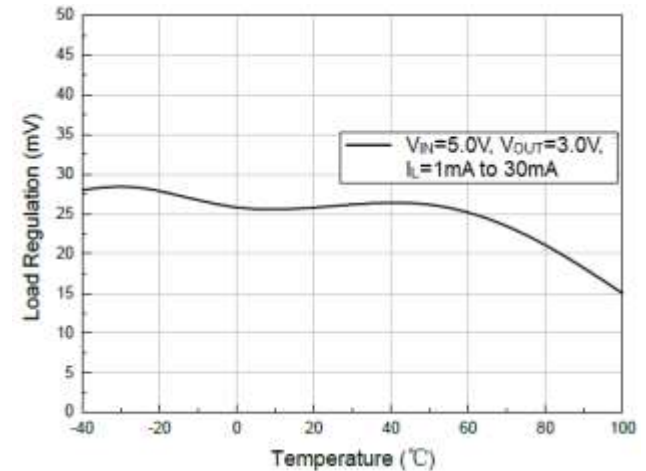



13. Input voltage transient response ($I_L=10\text{mA}$)

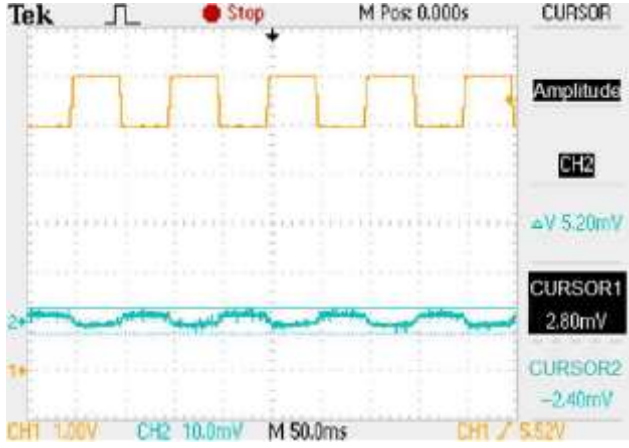

14. Load transient response ($V_{IN}=4.3\text{V}$, $I_L=0-70-0\text{mA}$)

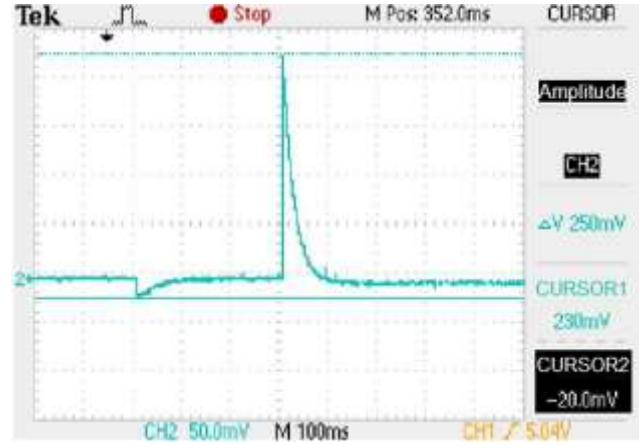



BLOCK DIAGRAM

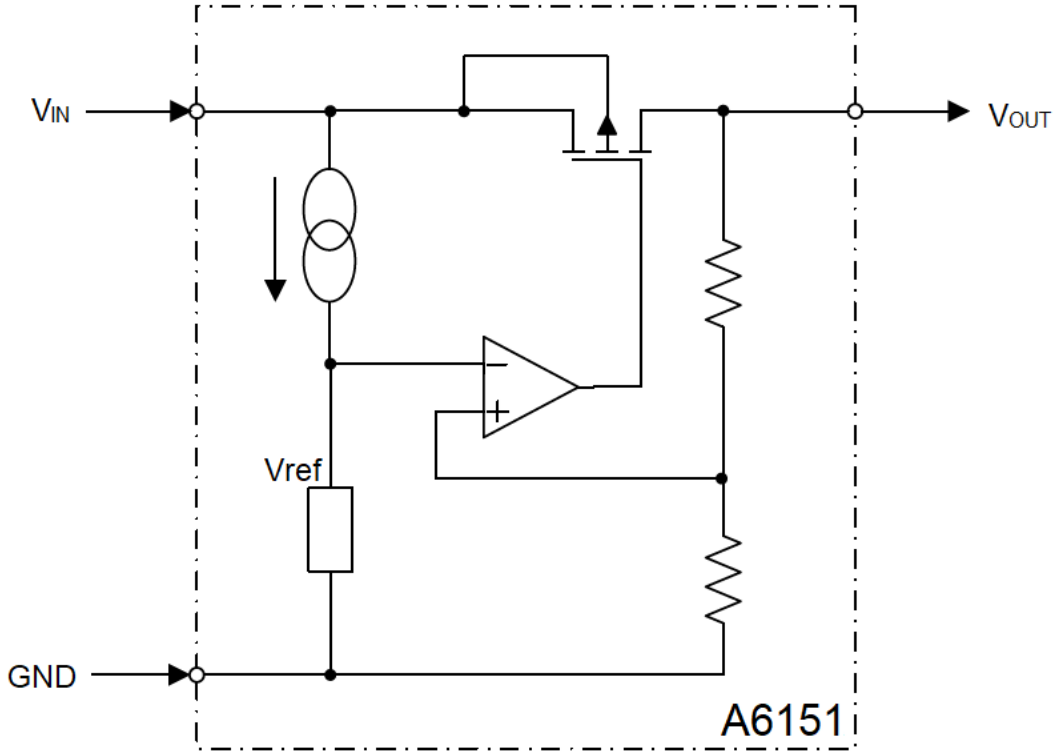



PACKAGE INFORMATION

Dimension in SOT89-3 (Unit: mm)

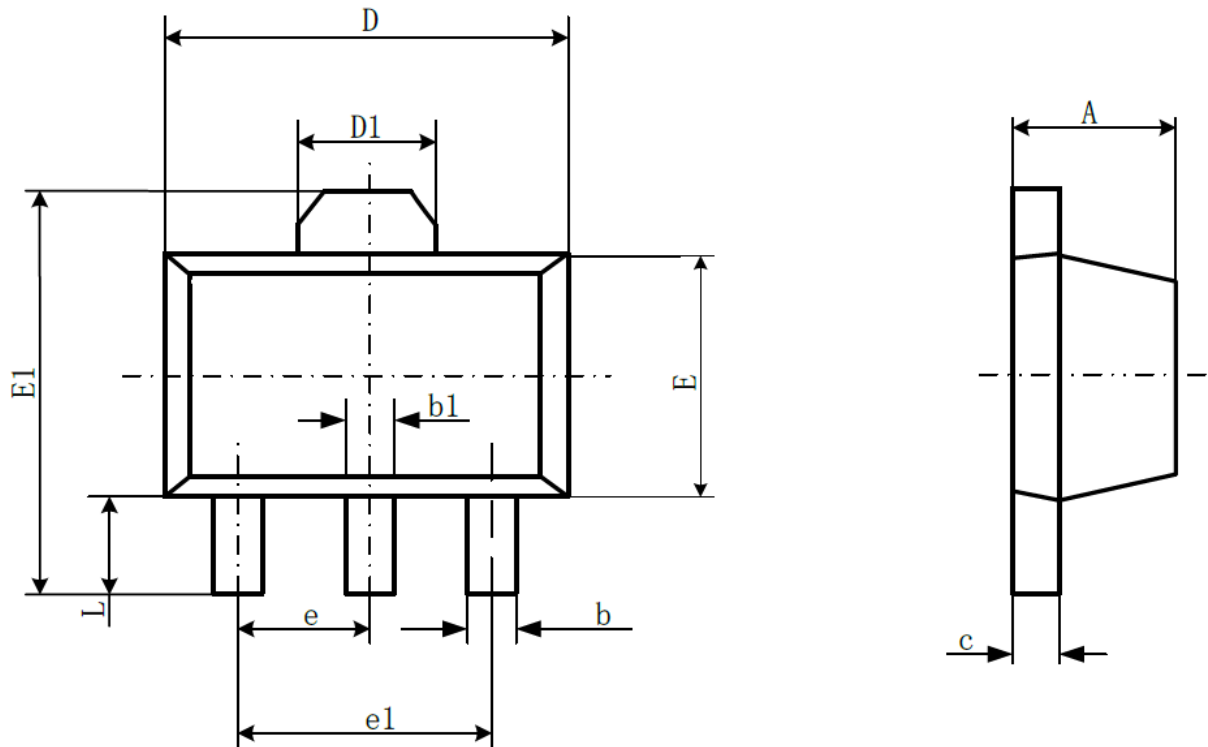

Symbol	Millimeters		Inches	
	Min	Max	Min	Max
A	1.400	1.600	0.055	0.063
b	0.320	0.520	0.013	0.020
b1	0.400	0.580	0.016	0.023
c	0.350	0.440	0.014	0.017
D	4.400	4.600	0.173	0.181
D1	1.550 REF		0.061 REF	
E	2.300	2.600	0.091	0.102
E1	3.940	4.250	0.155	0.167
e	1.500 TYP		0.060 TYP	
e1	3.000 TYP		0.118 TYP	
L	0.900	1.200	0.035	0.047



IMPORTANT NOTICE

AiT Semiconductor Inc. (AiT) reserves the right to make changes to any its product, specifications, to discontinue any integrated circuit product or service without notice, and advises its customers to obtain the latest version of relevant information to verify, before placing orders, that the information being relied on is current.

AiT Semiconductor Inc.'s integrated circuit products are not designed, intended, authorized, or warranted to be suitable for use in life support applications, devices or systems or other critical applications. Use of AiT products in such applications is understood to be fully at the risk of the customer. As used herein may involve potential risks of death, personal injury, or server property, or environmental damage. In order to minimize risks associated with the customer's applications, the customer should provide adequate design and operating safeguards.

AiT Semiconductor Inc. assumes to no liability to customer product design or application support. AiT warrants the performance of its products of the specifications applicable at the time of sale.