

ATS665LSG

True Zero Speed, High Accuracy, Gear Tooth Sensor

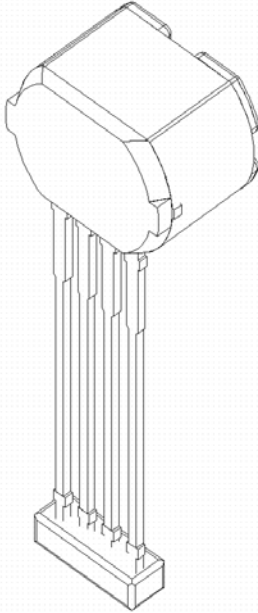

Pin 1: V_{CC}
Pin 2: V_{OUT}
Pin 3: Tie to Gnd or Float
Pin 4: Gnd

The ATS665 true zero-speed gear tooth sensor is an optimized Hall IC/magnet configuration packaged in a molded module that provides a user-friendly solution for digital gear tooth sensing applications. The sensor module consists of an over-molded package, which holds together a samarium cobalt magnet, a pole piece and a true zero-speed Hall IC that has been optimized to the magnetic circuit. This small package can be easily assembled and used in conjunction with gears of various shapes and sizes.

The sensor incorporates a dual element Hall IC that switches in response to differential magnetic signals created by a ferrous target. The IC contains a sophisticated compensating circuit designed to reduce the detrimental effects of magnet and system offsets. Digital processing of the analog signal provides zero speed performance independent of air gap and also dynamic adaptation of device performance to the typical operating conditions found in automotive applications (reduced vibration sensitivity). High-resolution peak detecting DACs are used to set the adaptive switching thresholds of the device. Hysteresis in the thresholds reduces the negative effects of any anomalies in the magnetic signal associated with the targets used in many automotive applications.

This sensor's ability to provide tight duty cycle at high speeds and over a wide temperature range makes it ideal for transmission and industrial speed applications. The ATS665 is available in the SG package in the automotive temperature range, -40° to 150° (L).

FEATURES & BENEFITS

- ♦ True zero-speed operation
- ♦ Switchpoints independent of air gap
- ♦ High vibration immunity
- ♦ Precise duty cycle signal over operating temperature range
- ♦ Large operating air gaps
- ♦ Defined power-on state
- ♦ Wide operating voltage range
- ♦ Digital output representing target profile
- ♦ Single-chip sensing IC for high reliability
- ♦ Small mechanical size
- ♦ Optimized Hall IC magnetic system
- ♦ 200 μ s power-on time at gear speed < 100 rpm
- ♦ AGC and reference adjust circuit
- ♦ Under-voltage lockout

ABSOLUTE MAXIMUM RATINGS

Supply Voltage ¹ ,	
V_{CC}	26.5 V
Reverse Supply Voltage,	
V_{RCC}	-18 V
Reverse Output Current ² ,	
I_{RCC}	50 mA
Continuous Output Current,	
I_{OUT}	20 mA
Ambient Operating Temperature Range,	
T_A	-40° C to 150° C
Storage Temperature,	
T_S	-65° C to 170° C
Maximum Junction Temperature,	
T_{Jmax}	165 $^{\circ}$ C

Order by: ATS665LSGTM-T (Pb-free, 800 pieces/reel).

(Pb-based variants are being phased out of the product line. ATS665LSGTM is in production but have been determined to be NOT FOR NEW DESIGN. This classification indicates that sale of this device is currently restricted to existing customer applications. The device should not be purchased for new design applications because obsolescence in the near future is probable. Samples are no longer available. Status change: May 1, 2006.)

¹ Refer to power de-rating curve

² $V_{OUT} \geq -0.5V$

ATS665LSG TRUE ZERO-SPEED GEAR TOOTH SENSOR

OPERATING CHARACTERISTICS

Valid at $T_A = -40^{\circ}\text{C}$ to 150°C over air gap, unless otherwise noted
Typical operating parameters: $V_{CC} = 12\text{ V}$ and $T_A = 25^{\circ}\text{C}$

Characteristics	Symbol	Test Conditions	Limits			
			Min.	Typ.	Max.	Units
ELECTRICAL CHARACTERISTICS						
Supply Voltage	V_{CC}	Operating; $T_j < T_{jmax}$	3.3	–	24	V
Under Voltage Lockout	$V_{CC(UV)}$		–	–	$< V_{CC\ min}$	V
Reverse Supply Current	I_{RCC}	$V_{CC} = -18\text{ V}$	–	–	-10	mA
Supply Zener Clamp Voltage	V_Z	$I_{CC} = I_{CCONMAX} + 3\text{mA}, T_A = 25^{\circ}\text{C}$	26.5	–	–	V
Supply Zener Current	I_Z	Test only; $V_{CC} = 28\text{V}, T_j < T_j(max)$	–	–	$I_{CCONmax} + 3$	mA
Supply Current	I_{CC}	Output OFF	–	8	14	mA
		Output ON	–	8	14	mA
POWER-ON STATE CHARACTERISTICS						
Power-On State	S_{PO}		–	High	–	
Power-On Time	t_{PO}	Gear Speed $< 100\text{ RPM}; V_{CC} > V_{CC\ min}$	–	–	200	μs
OUTPUT STAGE						
Low Output Voltage	V_{Sat}	Output = ON, $I_{SINK} = 20\text{ mA}$	–	225	400	mV
Output Current Limit	I_{lim}	$V_{OUT} = 12\text{ V}, T_j < T_j(max)$	25	45	70	mA
Output Leakage Current	I_{OFF}	Output = OFF, $V_{OUT} = 24\text{ V}$	–	–	10	μA
Output Rise Time	t_r	$R_{LOAD} = 500\ \Omega, C_{LOAD} = 10\text{ pF}$	–	1.0	2	μs
Output Fall Time	t_f	$R_{LOAD} = 500\ \Omega, C_{LOAD} = 10\text{ pF}$	–	0.6	2	μs
SWITCH POINT CHARACTERISTICS						
Target Speed	S	Reference target	0	–	12000	rpm
Bandwidth	f-3dB		–	20	–	kHz
Operate Point	B_{OP}	% of peak-to-peak signal, $AG < AG_{(max)}$	–	70	–	%
Release Point	B_{RP}	% of peak-to-peak signal, $AG < AG_{(max)}$	–	30	–	%

ATS665LSG TRUE ZERO-SPEED GEAR TOOTH SENSOR

CALIBRATION						
Initial Calibration		Start-up ³	-	2	6	Edges
Calibration Update		Running mode operation	Continuous			
OPERATING CHARACTERISTICS (with 60-0 reference target)						
Operational Air Gap	AG	Measured from sensor face to top of target tooth	0.5	-	2.5	mm
Duty Cycle		AG < AG _(max) , reference target	42	47	52	%
Operating Signal		Duty cycle spec compliance	60	-	-	G

REFERENCE TARGET/GEAR INFORMATION

³ Power-on speed \leq 200 rpm

Diameter	120	mm
Thickness	6	mm
Tooth Width	3	mm
Valley Width	3	mm
Valley Depth	3	mm
Material	Low carbon steel	

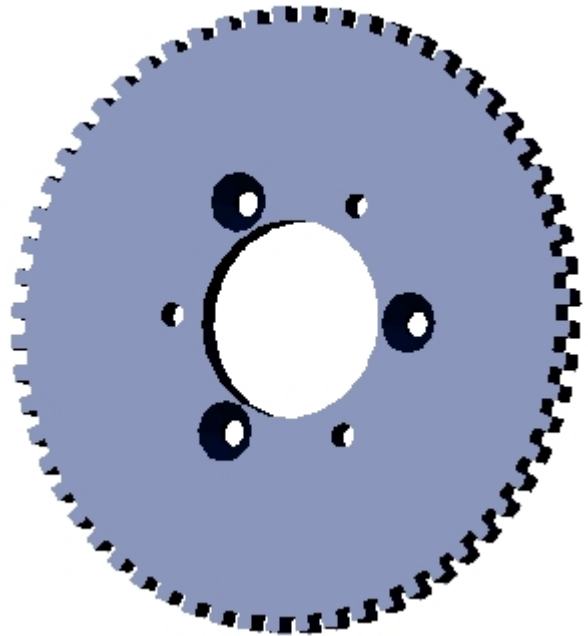

ATS665LSG TRUE ZERO-SPEED GEAR TOOTH SENSOR

SENSOR DESCRIPTION

Assembly Description:

The ATS665 true zero speed gear tooth sensor is a Hall IC/magnet configuration that is fully optimized to provide digital detection of gear tooth edges. This sensor is integrally molded into a plastic body that has been optimized for size, ease of assembly, and manufacturability. High operating temperature materials are used in all aspects of construction.

Sensing Technology:

The gear tooth sensor sub-assembly contains a single-chip differential Hall effect sensor IC, a Samarium Cobalt magnet, and a flat ferrous pole piece. The Hall IC consists of two Hall elements spaced 2.2 mm apart which measure the magnetic gradient created by the passing of a ferrous object. The gradient is converted to an analog voltage that is then processed to provide a digital output signal.

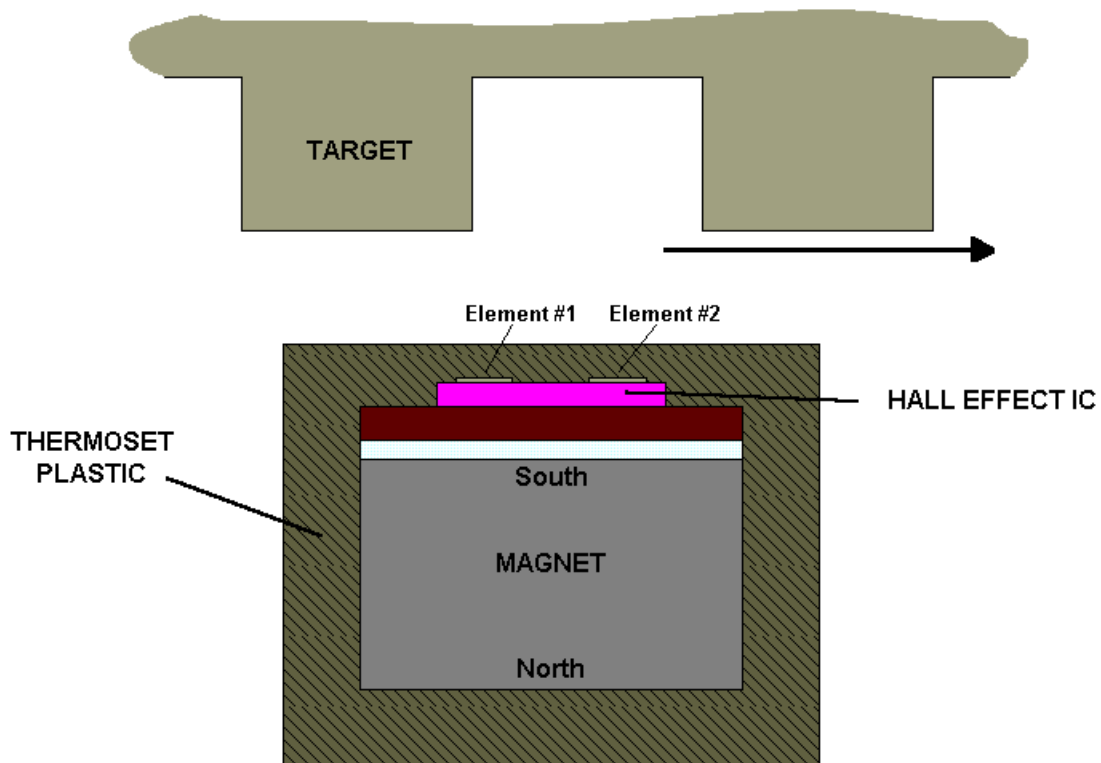

ATS665LSG TRUE ZERO-SPEED GEAR TOOTH SENSOR

Operation:

After proper power is applied to the component the sensor is then capable of providing digital information that is representative of the profile of a rotating gear. No additional optimization is needed and minimal processing circuitry is required. This ease of use should reduce design time and incremental assembly costs for most applications. The following output diagram is indicative of the sensor performance for the polarity indicated in the figure at the bottom of the page.

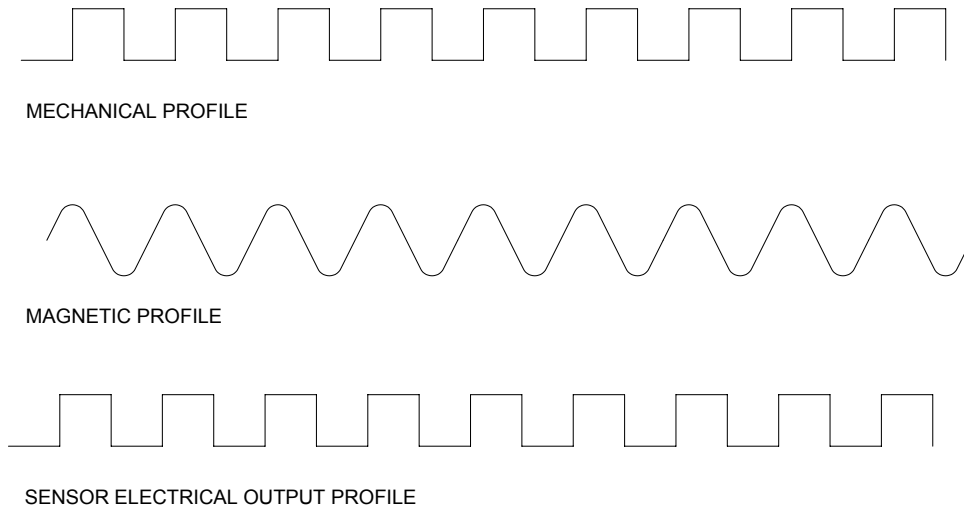

Output Polarity:

The output of the sensor will switch from LOW to HIGH as the leading edge of the tooth passes the sensor face in the direction indicated in the figure below. In this system configuration, the output voltage will be high when the sensor is facing a tooth. If rotation occurs in the opposite direction, the output polarity will invert.

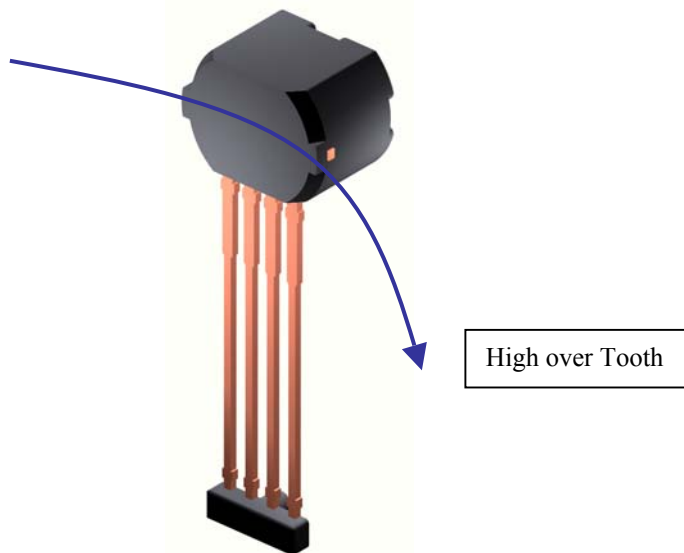

Power-On State Operation:

The device is guaranteed to power up in the OFF state (logic high output).

ATS665LSG TRUE ZERO-SPEED GEAR TOOTH SENSOR

Start-up Detection:

Since the sensor powers up in the OFF state (logic high output), the first edge seen by the sensor can be missed if the switching induced by that edge reinforces the OFF state. Therefore, the first edge that can be guaranteed to induce an output transition is the second detected edge. This device has accurate first electrical falling edge detection. The tables below show various start-up schemes.

High over Tooth →

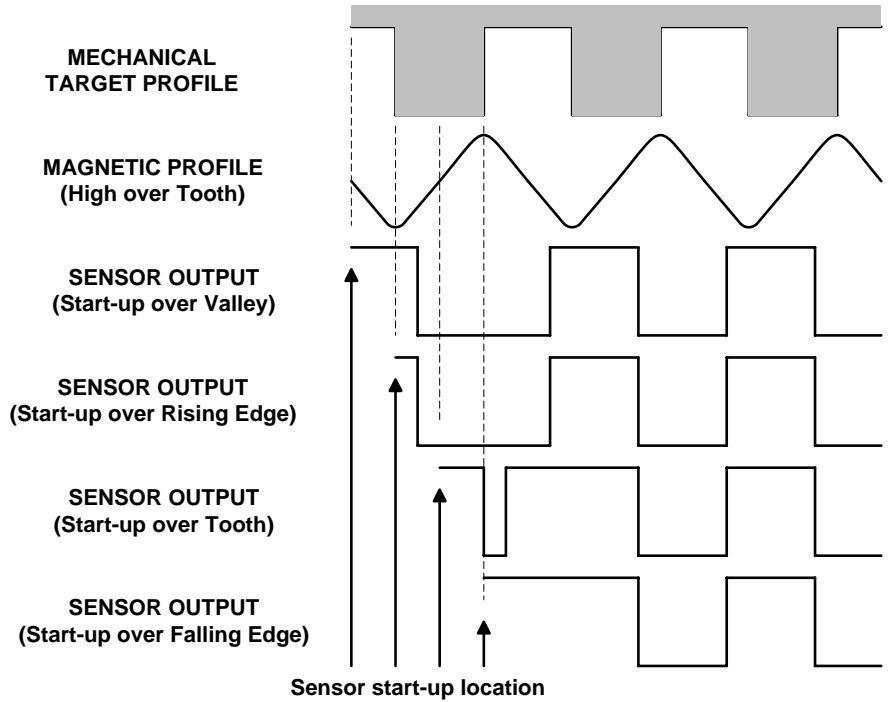

Low over Tooth →

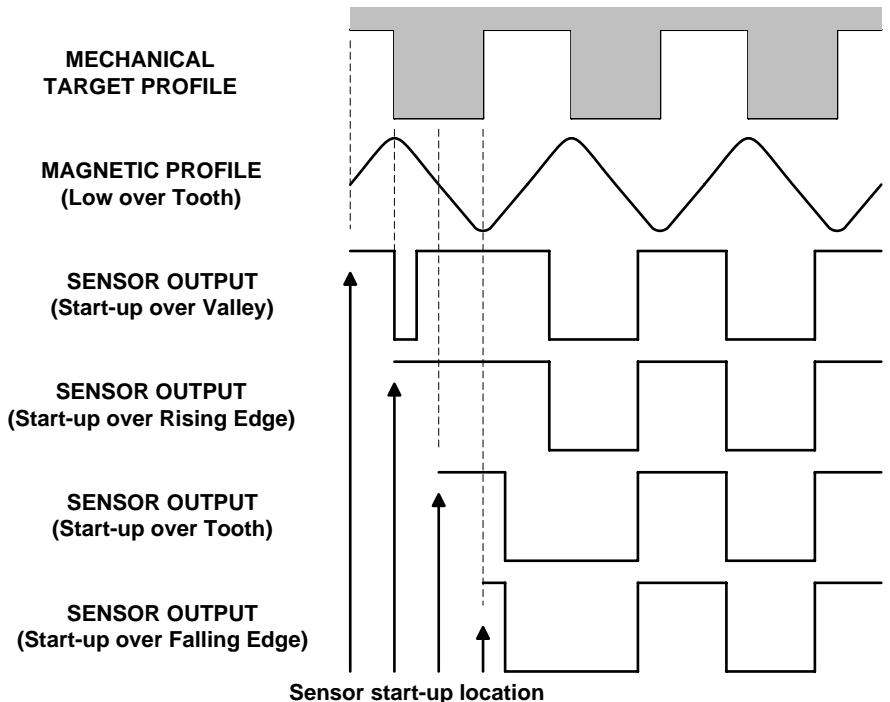

ATS665LSG TRUE ZERO-SPEED GEAR TOOTH SENSOR

Under-Voltage Lockout:

When the supply voltage falls below the minimum operating voltage ($V_{CC_{UV}}$), the device turns OFF and stays OFF irrespective of the state of the magnetic field. This prevents false signals caused by under-voltage conditions from propagating to the output of the sensor.

Power Supply Protection:

The device contains an on-chip regulator and can operate over a wide supply voltage range. For devices that need to operate from an unregulated power supply, transient protection must be added externally. For applications using a regulated line, EMI/RFI protection may still be required. The following circuit is the most basic configuration required for proper device operation. For EMC information, contact your Allegro representative.

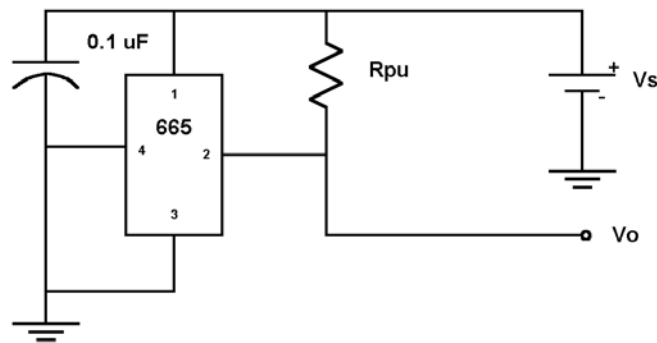

Internal Electronics:

The ATS665 contains a self-calibrating Hall effect IC that possesses two Hall elements, a temperature compensated amplifier and offset cancellation circuitry. The IC also contains a voltage regulator that provides supply noise rejection over the operating voltage range. The Hall transducers and the electronics are integrated on the same silicon substrate using a proprietary BiCMOS process. Changes in temperature do not greatly affect this device due to the stable amplifier design and the offset rejection circuitry.

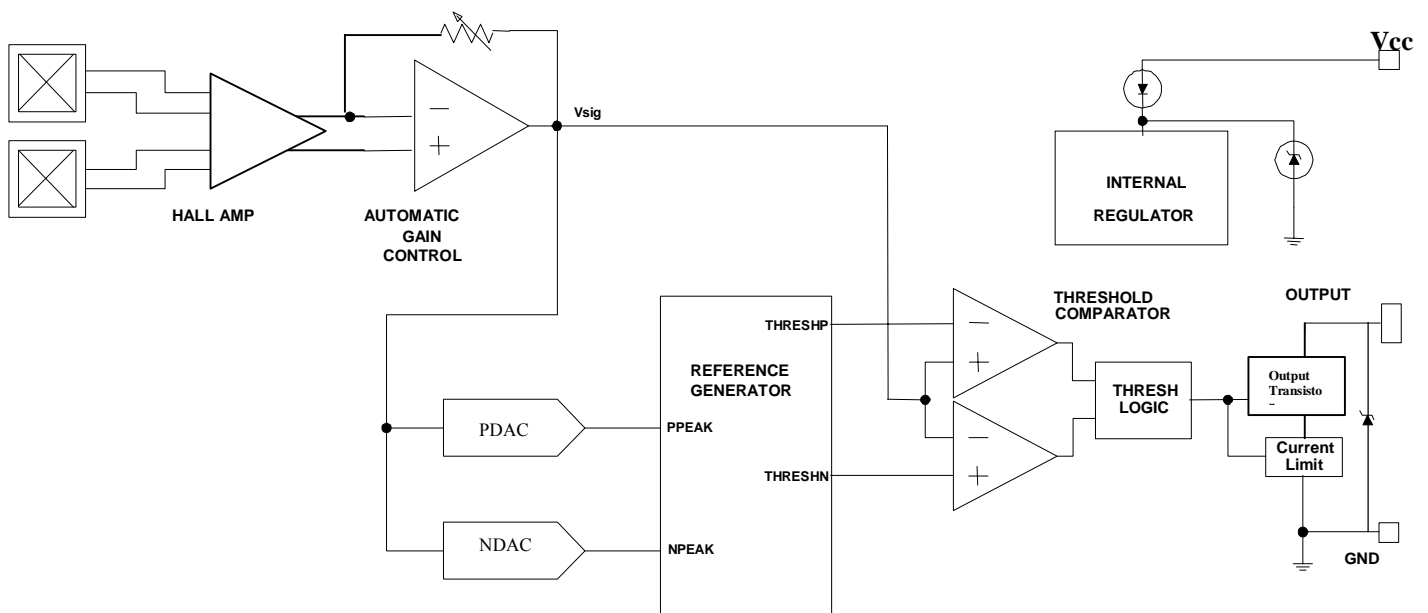

ATS665LSG TRUE ZERO-SPEED GEAR TOOTH SENSOR

SENSOR OPERATION: AUTOMATIC GAIN CONTROL (AGC)

The patented self-calibrating circuitry is unique. After each power up, the device measures the peak-to-peak magnetic signal. The gain of the sensor is then adjusted which keeps the internal signal amplitude constant over the air gap range of the device. This feature provides operational characteristics independent of air gap.

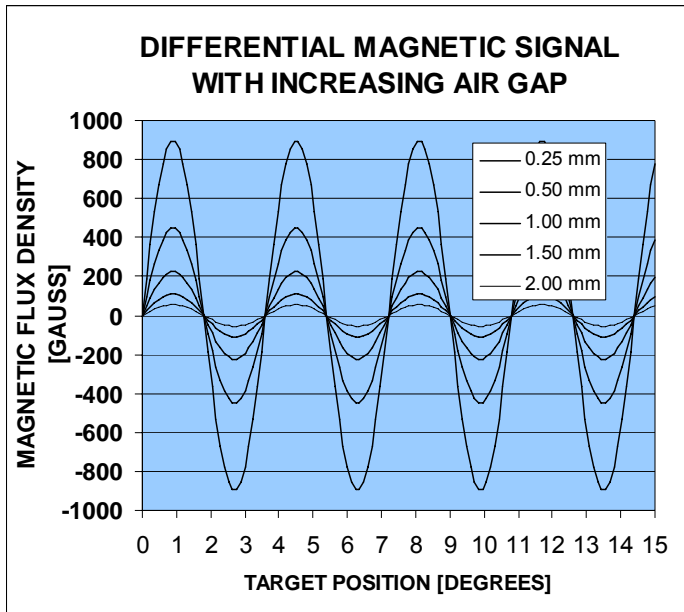

Magnetic Signal with no Amplification

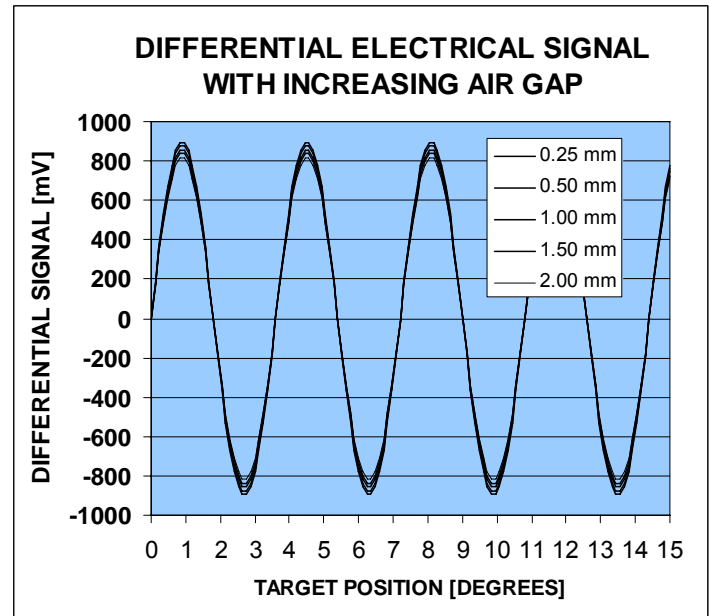

Electrical Signal after AGC

SENSOR OPERATION: OFFSET ADJUST

In addition to normalizing performance over air gap, the gain control circuitry also reduces the effect of chip, magnet, and installation offsets. This is accomplished using two D/A converters that capture the peak and valley of the signal and use it as a reference for the switching comparator. If induced offsets bias the absolute signal up or down, AGC and the dynamic DAC behavior work to normalize and reduce the impact of the offset on sensor performance.

ATS665LSG TRUE ZERO-SPEED GEAR TOOTH SENSOR

SENSOR OPERATION: SWITCHPOINTS

Switchpoints in the ATS665 are established dynamically as a percentage of the amplitude of the normalized magnetic signal. Two DACs track the peaks of the normalized magnetic signal (see the section on Update); the switching thresholds are established at 30% and 70% of the two DAC's values. The proximity of the thresholds near 50% ensures the most accurate and consistent switching where the signal is steepest and least affected by air gap variation.

The hysteresis of 40% provides high air gap performance and immunity to false switching on noise, vibration, backlash and other transient events. Since the hysteresis value is independent of air gap, it provides protection against false switching in the presence of overshoot that can be induced on the edges of large teeth.

The figure below graphically demonstrates the establishment of the switching threshold levels.

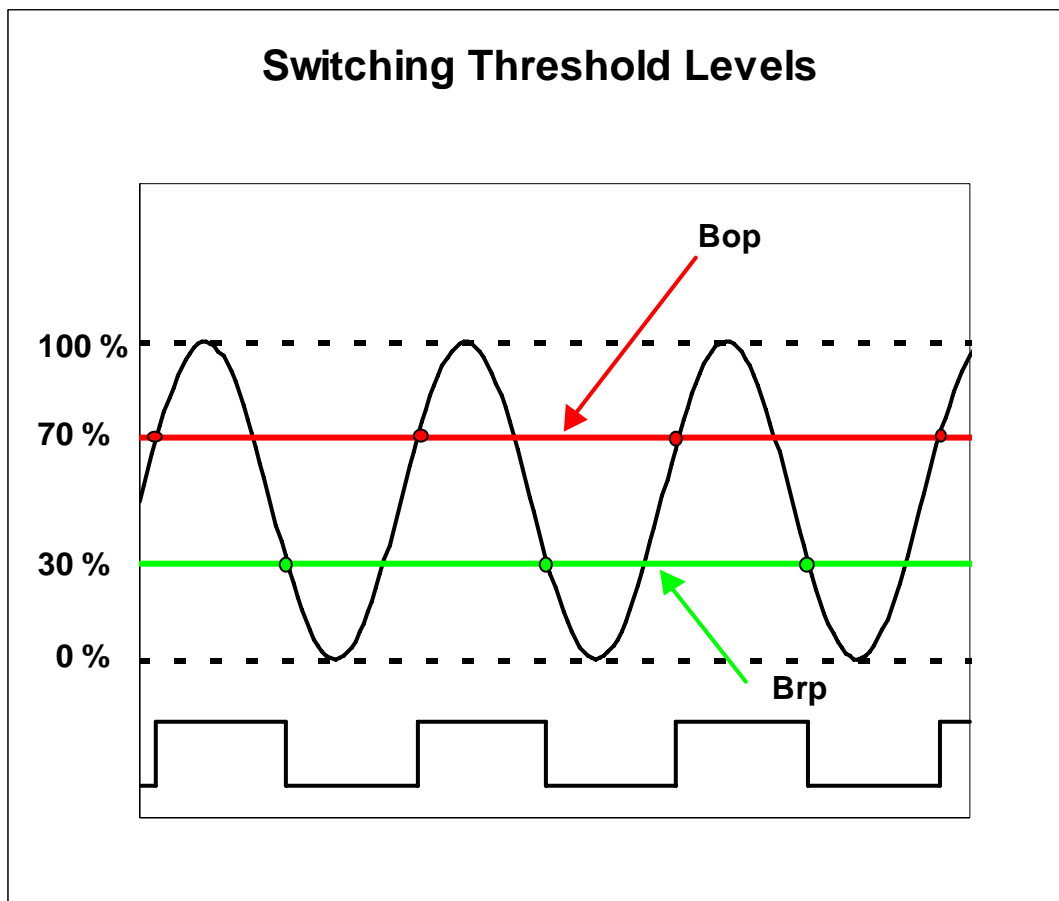

Because the threshold are established dynamically as a percentage of the peak-peak signal, the effect of a baseline shift is minimized. As a result, the effects of offsets induced by tilted or off-center installation are minimized.

ATS665LSG TRUE ZERO-SPEED GEAR TOOTH SENSOR

SENSOR OPERATION: UPDATE

The ATS665 incorporates an algorithm that continuously monitors the system and updates the switching thresholds accordingly. The switch point for each edge is determined by the previous two edges. Since variations are tracked in real time, the sensor has high immunity to target run-out and retains excellent accuracy and functionality in the presence of both run-out and transient mechanical events. The figures below show how the sensor uses historical data to provide the switching threshold for a given edge.

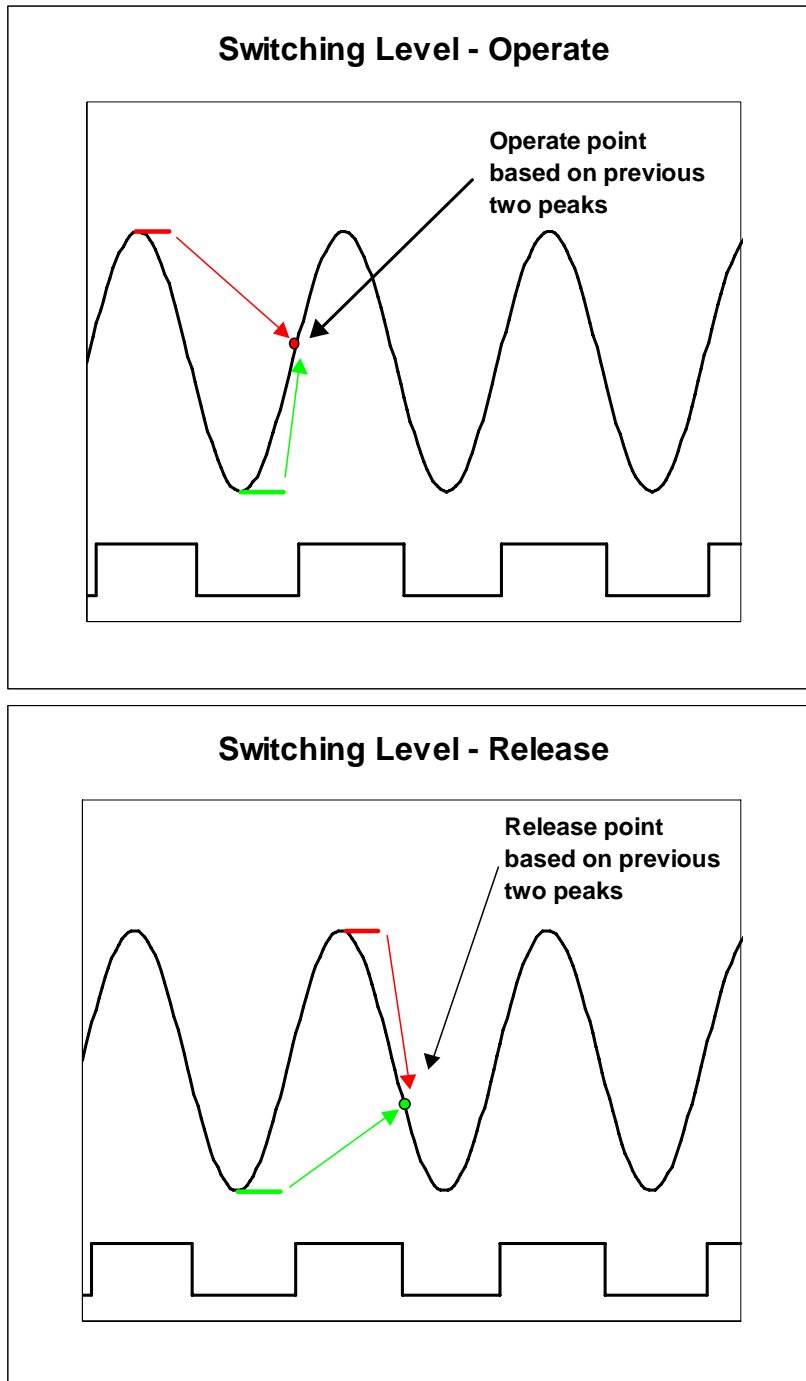

ATS665LSG TRUE ZERO-SPEED GEAR TOOTH SENSOR

SENSOR/TARGET EVALUATION

In order to establish the proper operating specification for a particular sensor/target system, a systematic evaluation of the magnetic circuit should be performed. The first step is the generation of a magnetic map of the target. By using a calibrated device, a magnetic signature of the system is made. The following is a map of the 60-0 reference target. Flux density shown is the differential of the magnetic fields sensed at the two Hall elements.

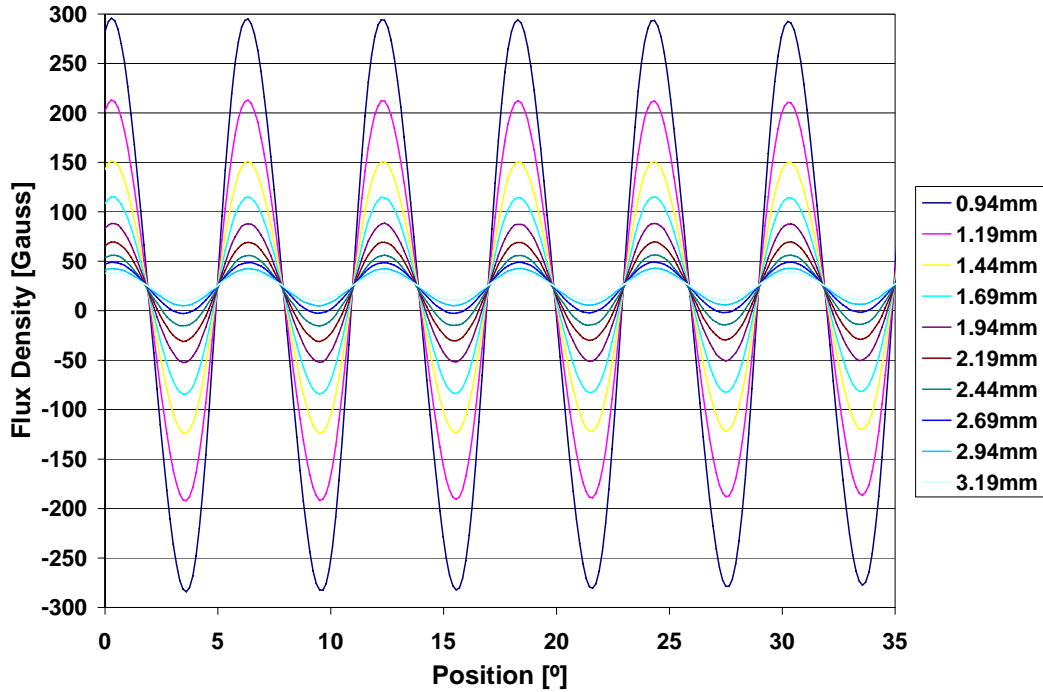

A single curve is distilled from this map data that describes the peak-peak magnetic field versus air gap. Knowing the minimum amount of magnetic flux density that guarantees operation of the sensor, one can determine the maximum operational air gap of the sensor/target system. Referring to the chart below, a minimum required peak-peak signal of 60G corresponds to a maximum air gap of approximately 2.5 mm.

ATS665LSG 60-0 TARGET MAP

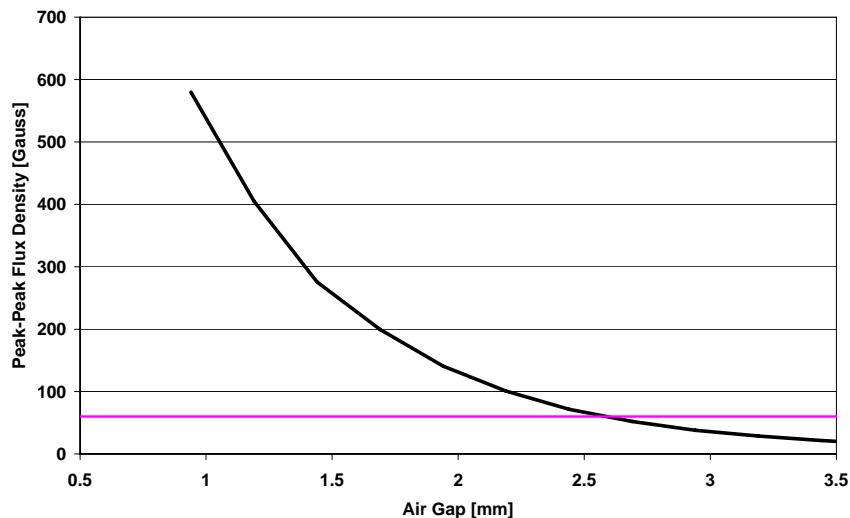

ATS665LSG TRUE ZERO-SPEED GEAR TOOTH SENSOR

TARGET DESIGN

For the generation of adequate magnetic field levels to maximize air gap performance, the following recommendations should be followed in the design and specification of targets.

- Tooth width > 2 mm
- Valley width > 2 mm
- Valley depth > 2 mm
- Gear thickness > 3 mm
- Target material must be low carbon steel

Though these parameters apply to targets of traditional geometry (radially oriented teeth with radial sensing), they can be applied to stamped targets as well. For stamped geometries with axial sensing, the valley depth is intrinsically infinite so the criteria for tooth width, valley width, material thickness (can be < 3 mm) and material specification need only be considered.

SENSOR EVALUATION: ACCURACY

While the update algorithm will allow the sensor to adapt to system changes (i.e. air gap increase), major changes in air gap can adversely affect switching performance. When characterizing sensor performance over a significant air gap range, be sure to re-power the device at each air gap. This ensures that self-calibration occurs for each installation condition. See the section entitled Characteristic Data for typical duty cycle performance.

ATS665LSG TRUE ZERO-SPEED GEAR TOOTH SENSOR

POWER DE-RATING

Due to internal power consumption, the junction temperature of the IC, T_j , is higher than the ambient environment temperature, T_a . To ensure that the device does not operate above the maximum rated junction temperature use the following calculations:

$$\Delta T = P_D * R\theta_{ja}$$

Where: $P_D = V_{cc} * I_{cc}$

$$\therefore \Delta T = V_{cc} * I_{cc} * R\theta_{ja}$$

Where ΔT denotes the temperature rise resulting from the IC's power dissipation.

$$T_j = T_a + \Delta T$$

For the sensor :

$$T_j(\text{max}) = 165^\circ\text{C}$$

$$R\theta_{ja} = 126^\circ\text{C/W}$$

Typical T_j calculation:

$$T_a = 25^\circ\text{C}$$

$$V_{cc} = 5\text{ V}$$

$$I_{cc} = 7.0\text{ mA}$$

$$P_D = V_{cc} * I_{cc} = 5\text{ V} * 8.0\text{ mA} = 40.0\text{ mW}$$

$$\Delta T = P_D * R\theta_{ja} = 40.0\text{ mW} * 126^\circ\text{C/W} = 5.0^\circ\text{C}$$

$$T_j = T_a + \Delta T = 25^\circ\text{C} + 5.0^\circ\text{C} = 30.0^\circ\text{C}$$

Maximum Allowable Power Dissipation Calculation for ATS665:

Assume:

$$T_a = T_{a_{\text{max}}} = 165^\circ\text{C}$$

$$T_j(\text{max}) = 165^\circ\text{C}$$

$$I_{cc} = 12.0\text{ mA}^4$$

If:

⁴max I_{cc} @ 150C < max I_{cc} @ 25C, see characteristic data

$$T_j = T_a + \Delta T$$

Then, at $T_a = 150^\circ\text{C}$:

$$\Delta T_{\text{max}} = T_{j_{\text{max}}} - T_{a_{\text{max}}} = 165^\circ\text{C} - 150^\circ\text{C} = 15^\circ\text{C}$$

If:

$$\Delta T = P_D * R\theta_{ja}$$

Then, at $T_a = 150^\circ\text{C}$:

$$P_{D_{\text{max}}} = \Delta T_{\text{max}} / R\theta_{ja} = 15^\circ\text{C} / 126^\circ\text{C/W} = 119\text{ mW}$$

If:

$$P_D = V_{cc} * I_{cc}$$

Then the maximum V_{cc} at 150°C is therefore:

$$V_{cc_{\text{max}}} = P_{D_{\text{max}}} / I_{cc} = 119\text{ mW} / 12.0\text{ mA} = 9.9\text{ V}$$

This value applies only to the voltage drop across the 665 chip. If a protective series diode or resistor is used, the effective maximum supply voltage is increased.

For example, when a standard diode with a 0.7 V drop is used:

$$V_{s_{\text{max}}} = 9.9\text{ V} + 0.7\text{ V} = 10.6\text{ V}$$

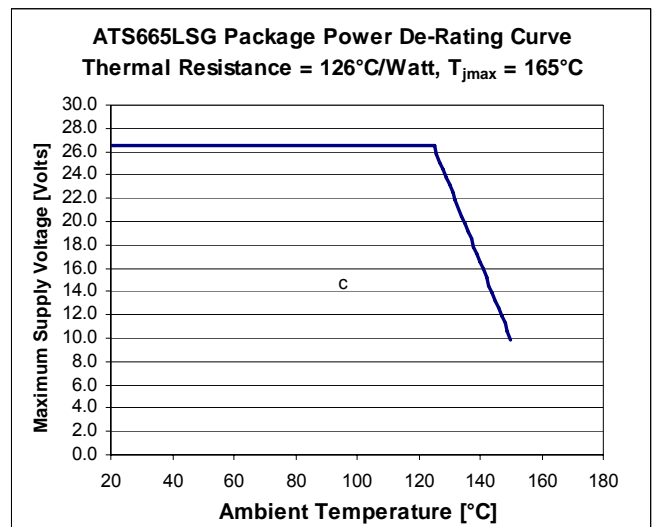

ATS665LSG TRUE ZERO-SPEED GEAR TOOTH SENSOR

CHARACTERISTIC DATA

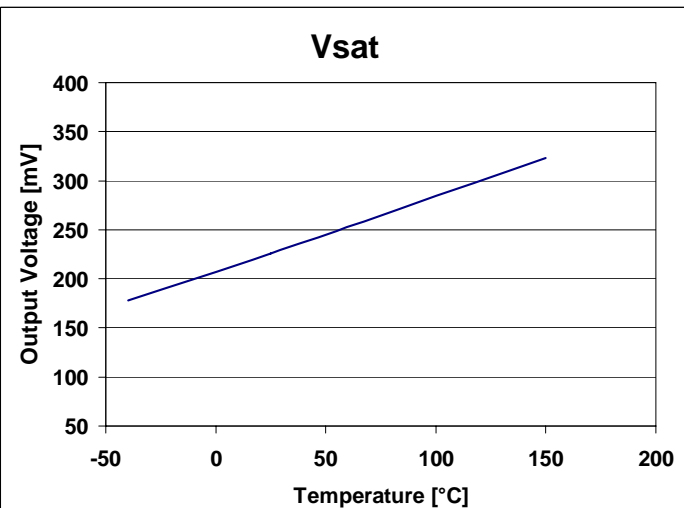
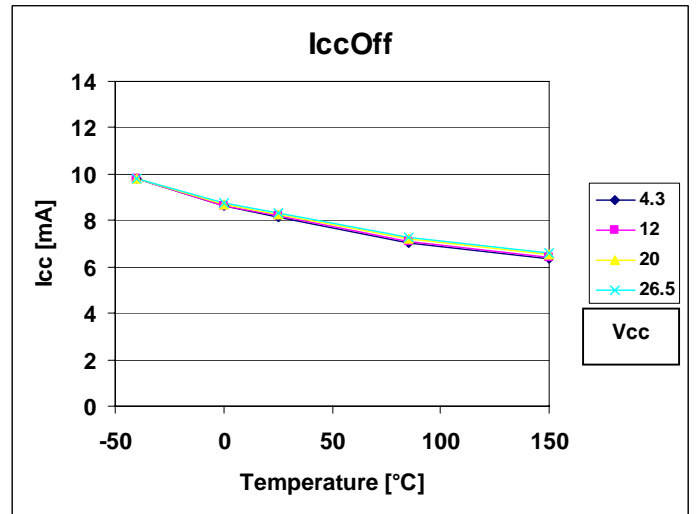
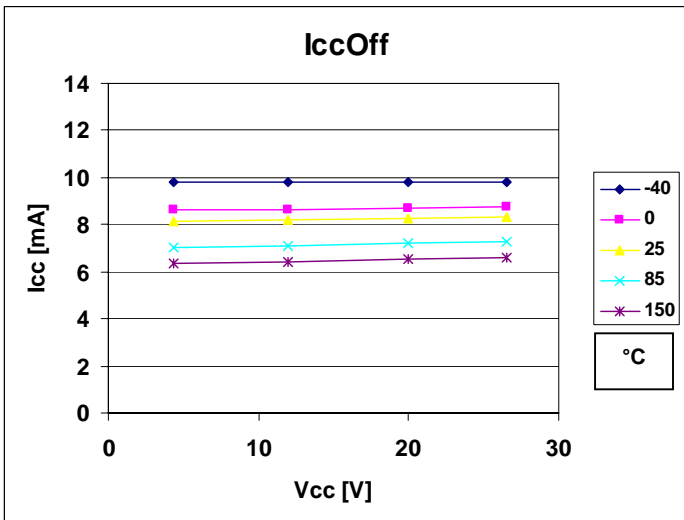
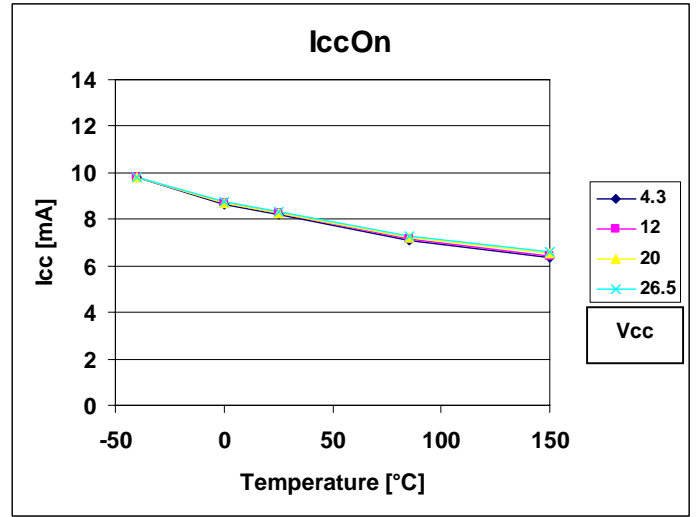
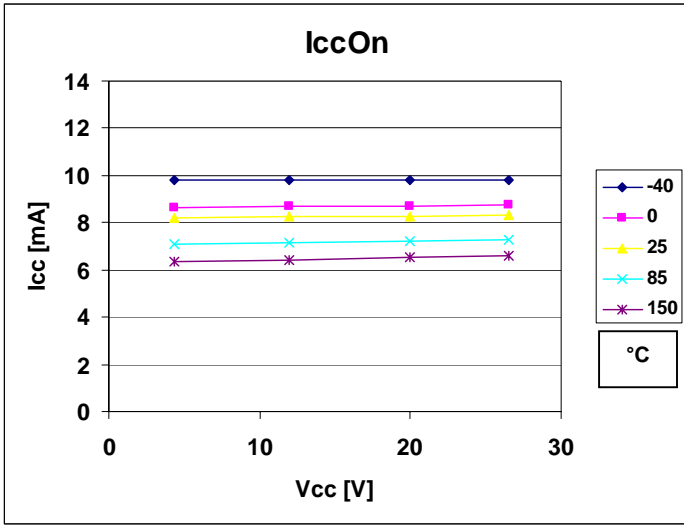

ATS665LSG TRUE ZERO-SPEED GEAR TOOTH SENSOR

CHARACTERISTIC DATA (Continued)

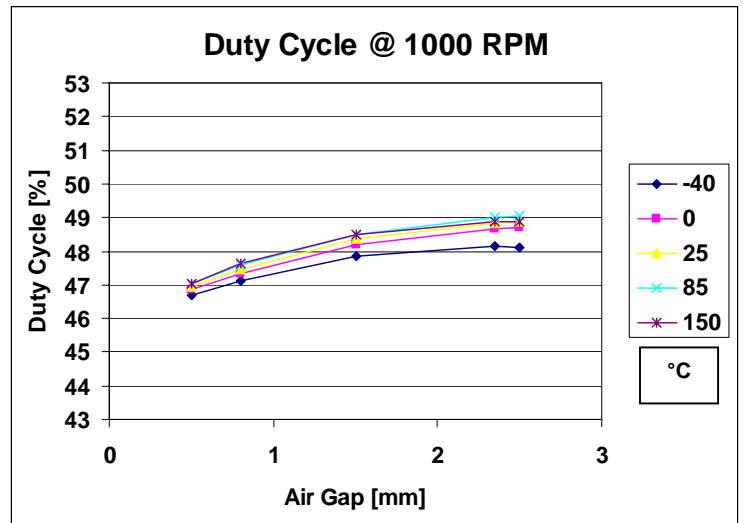
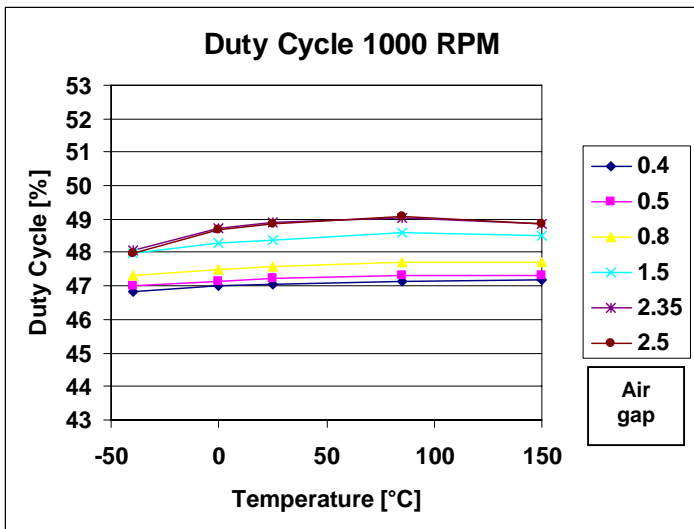
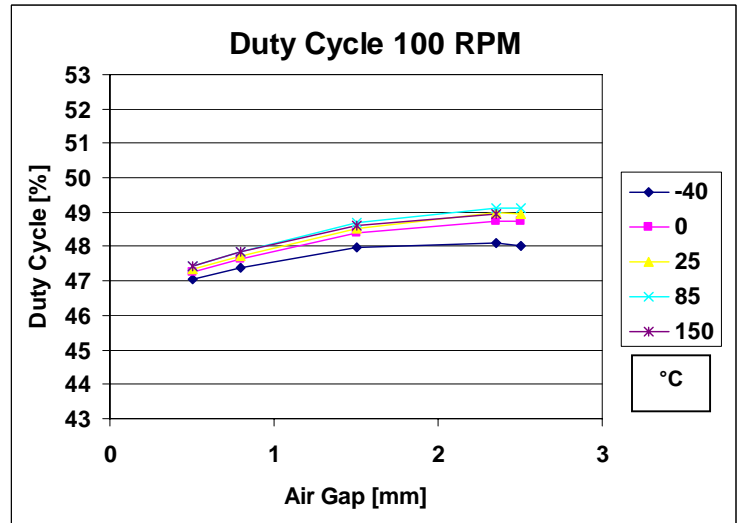
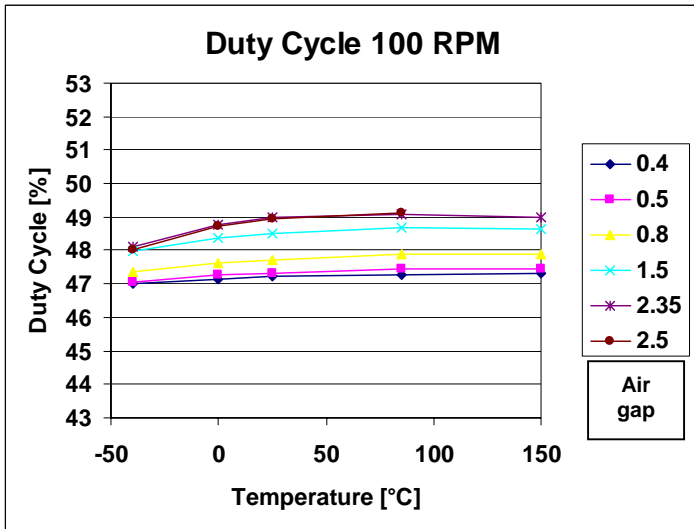

ATS665LSG TRUE ZERO-SPEED GEAR TOOTH SENSOR

PACKAGE DRAWING

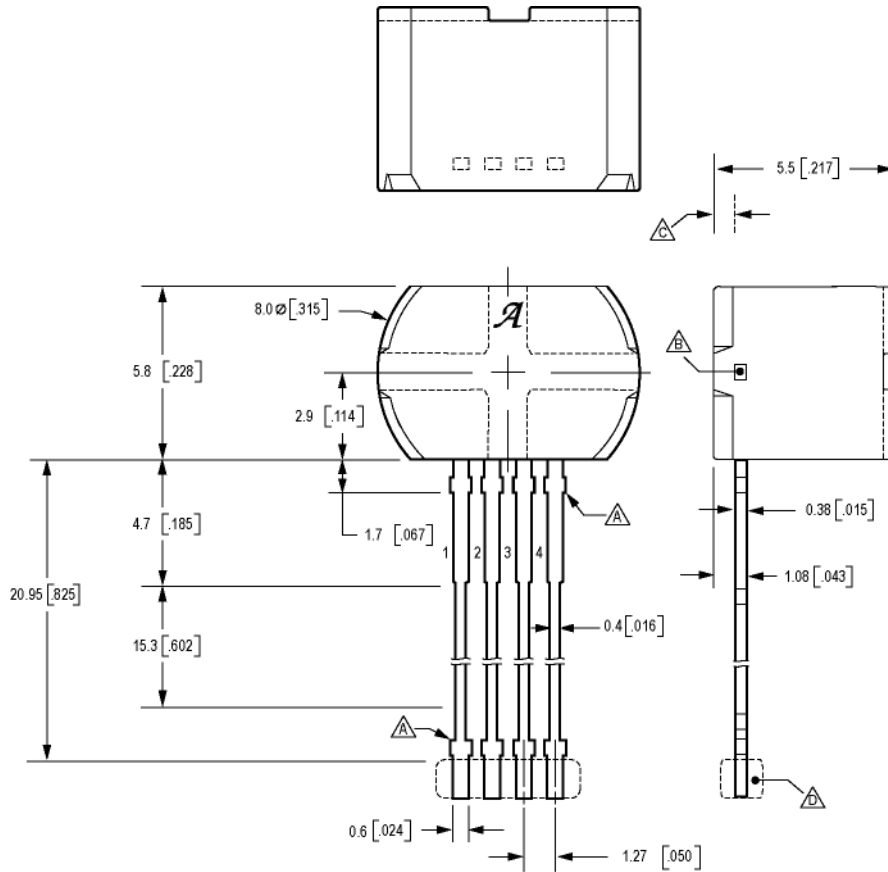

- Dimensions in millimeters. Untoleranced dimensions are nominal.
U.S. Customary dimensions (in.) in brackets, for reference only
- Dambar removal protrusion
 - Metallic protrusion, electrically connected to pin 4 and substrate (both sides)
 - Active Area Depth
 - Thermoplastic Molded Lead Bar for alignment during shipment

ATS665LSG TRUE ZERO-SPEED GEAR TOOTH SENSOR

RELATED DOCUMENTS

Documents that can be found on the Allegro Microsystems web site: www.allegromicro.com :

- Definition of Terms (Pub 26004)
- Hall-Effect Devices: Soldering, Gluing, Potting, Encapsulating, and Lead Forming (AN27703.1)
- Storage of Semiconductor Devices (Pub 26011)
- Hall Effect Applications Guide (Pub 27701)
- Applications Note: Back-Biased Packaging Advances (SE, SG & SH versus SA & SB)

Additional Applications Information on gear tooth and other Allegro sensors can be obtained at Allegro's web site, www.allegromicro.com