

Features

- Vout Range = 0.8375 to 1.6V per VRM10 VID Range
- DAC Programmable Duty Cycle Voltage
- Power Good Output
- Differential Remote Sense
- Remote Enable
- Supervisory Functions
 - Output Overcurrent
 - Short Circuit Protection
 - Overtemperature Indicator
 - Output Current Level Signal
- Tri-state Output when Disabled
- Dynamic VID Capability
- 1U Form Factor (1.250" total mating height)
- LL0 / LL1 Function
- 90% Efficiency at Full Load

NOT RECOMMENDED FOR NEW DESIGNS



Table 1:

Input Characteristics	Notes and Conditions (1)	Min	Typ	Max	Units
Input Voltage Operating Range		11.04	12.0	12.60	Vdc
Input Undervoltage Lockout	Turn-on Threshold	6.5	6.9	7.3	Vdc
	Turn-off Threshold	5.4	6.0	6.6	Vdc
	Hysteresis Voltage	0.7	0.9	1.1	Vdc
Recommended Input Capacitance	Sanyo 16SP270M		2		each
No-Load Input Current	Enable state, no Load	200	320	400	mA
Disabled Input Current	Disabled State	20	30	50	mA
Enable - Positive Logic Version	On State Range	0.8		Vin	Vdc
	Off State Range	-0.3		0.4	Vdc
LL0 and LL1	High State Range	0.8		3.5	Vdc
	Low State Range	-0.3		0.4	Vdc

Table 2:

Output Characteristics	Notes and Conditions (1)	Min	Typ	Max	Units
Output Voltage Set Point	6-Bit DAC Controlled	0.8375		1.600	Vdc
Output Line Regulation		-5	0	5	mV
Output Load Regulation	Adjustable	0.91		1.25	mΩ
Output Voltage Total Regulation				VID-40	mV
Output Ripple Voltage & Noise (2)	20 MHz Bandwidth		6.4		mVp-p
Output Current Operating Range		0		80	A
Efficiency	Io = 70 Amps VID = 1.325	87	90		%
Turn-on Time	Vin present: Enable to 90% Vout			50	mS
Transient Response (3) Overshoot Recovery within 25μSec	46A step, 500A/μS			50	mV

Table 2:

Output Characteristics	Notes and Conditions (1)	Min	Typ	Max	Units
Remote Sense Compensation Range (4)				300	mV
Recommended Bulk Output Capacitance	UCC 4PS560MH11 or Panasonic EEFSDOD471R		10		EA

Table 3:

Protection Characteristics	Notes and Conditions (1)	Min	Typ	Max	Units
Output Overcurrent Shutdown	Latching	83		120	A
Overvoltage Shutdown	Above VID	90		200	mV
Overtemperature Indicator	Non-Latching, at hot spots Worst case junction temperature		125		°C
Load Indicator	VID = 1.325, 0A Load, LL1 = 1		1		V
	VID = 1.325, 100A Load, LL1 = 1		3		V
	VID = 1.325, 0A Load, LL1 = 0		1		V
	VID = 1.325, 100A Load, LL1 = 0		3.75		V

Table 4:

General Characteristics	Notes and Conditions (1)	Min	Typ	Max	Units
Storage Temperature Range	Non-condensing	-40		70	°C
Operating Ambient Temperature Range (7)		0		65	°C
Semiconductor Junction Temperature	Package rated to 150°C			110	°C
Material Flammability	UL 94V-0				
MTBF	Calculated (RAC PRISM) @ 45°C		0.93		x10 ⁶ Hrs
Switching Frequency	Per phase		300		KHz
Dimensions	3.8"L x 1.18"H x 0.475"W				
Weight			30		g

Table 5:

Adaptive Voltage Positioning	Notes and Conditions (1)	Min	Typ	Max	Units
Voltage Droop for 100A Load (linear)	LL0 = X, LL1 = 0		125		mV
	LL0 = X, LL1 = 1		91		

Notes:

1. Vin = 12Vdc, Ta = 25°C, Airflow = 400LFM unless otherwise noted.
2. Output Ripple Voltage is specified when measured with Intel specified capacitance at the output of the converter.
3. Transient response is specified with Intel specified capacitors at the output of the converter.
4. If remote sense is not required or used, the Sense(+) and Sense(-) pins must be connected to Vo(+) and Vo(-) respectively.
5. User will select the appropriate Load Line through the LL0 and LL1 signals. LL0 and LL1 signals are TTL compatible. The default state is a 1.25mOhm Load Line.
6. VRM_PRES and VRM_ID are connected to Vss on the VRM.
7. During operation within Thermal Derating Curve boundaries.

Mechanical Information

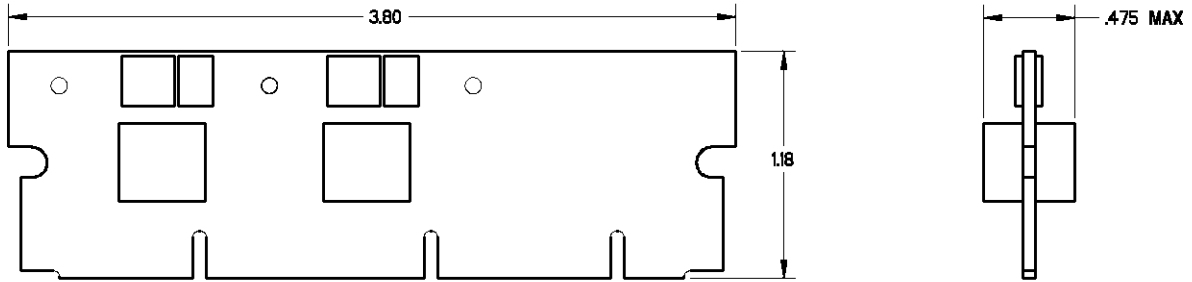

TOTAL MATING HEIGHT 1.25
 TOLERANCES ARE:
 X ± .1
 .XX ± .03
 .XXX ± .010

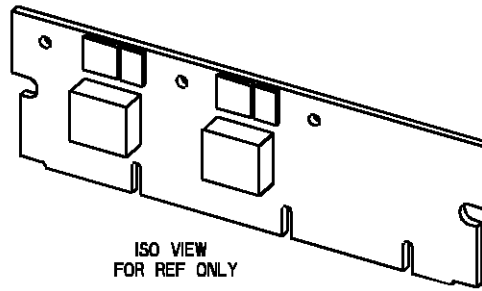

Figure 1

Recommended Interface Connector Options

- Tyco/Elcon 283-0172-01303 (Solder Tail, Long)
- 283-0172-02303 (Solder Tail, Short)
- 284-0202-03003 (Surface Mount)

Pin Assignment

1	VSS
2	VSS
3	VSS
4	VID4
5	VID2
6	VID0
7	Vo_sen+
8	PWRGD
9	OUTEN
10	Load Current
11	N/C
(6) 12	VRM_Pres
13	VO+
14	VO+
15	VO+
16	VSS
17	VSS
18	VSS
19	VO+
20	VO+
21	VO+
22	VSS
23	VSS
24	VSS
25	VO+
26	VO+
27	VO+

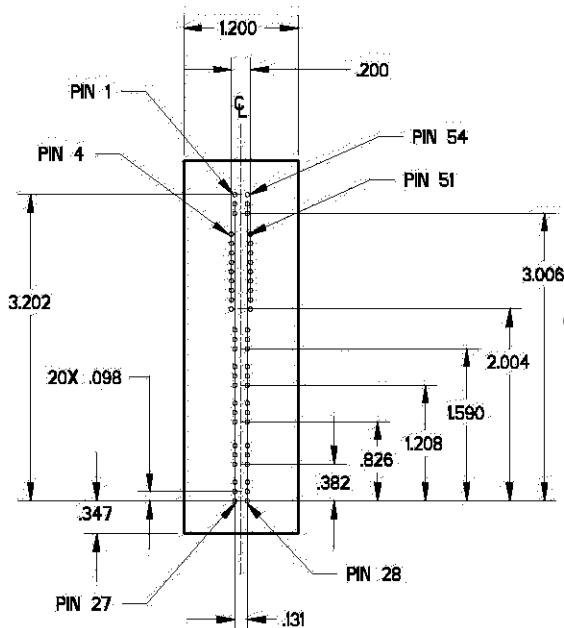

54	VIN+
53	VIN+
52	VIN+
51	VID3
50	VID1
49	VID5
48	VO_SEN-
47	VR_HOT
46	LL0
45	LL1
44	N/C
(6) 43	N/C
42	VO+
41	VO+
40	VO+
39	VSS
38	VSS
37	VSS
36	VO+
35	VO+
34	VO+
33	VSS
32	VSS
31	VSS
30	VO+
29	VO+
28	VO+

NOTE :
CHECK WITH MANUFACTURE FOR RECOMMENDED PCB LAYOUT .

Thermal Derating Curves

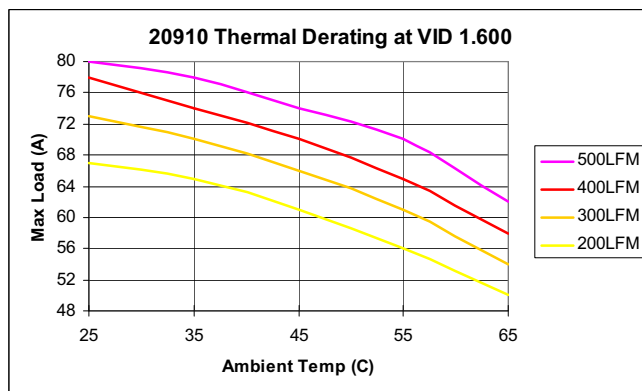
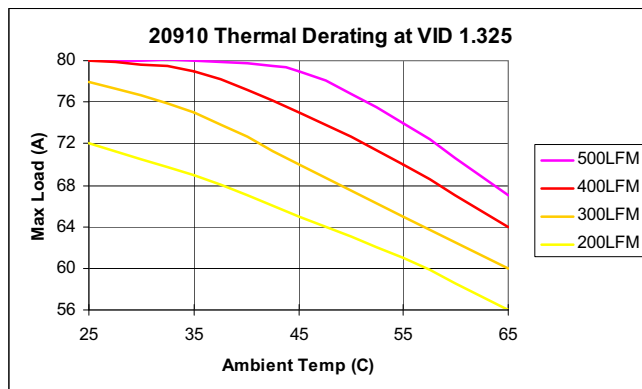

Efficiency Curve

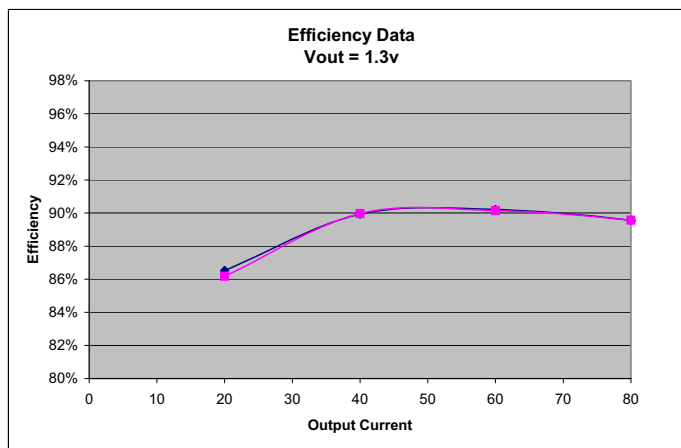

Ordering Information

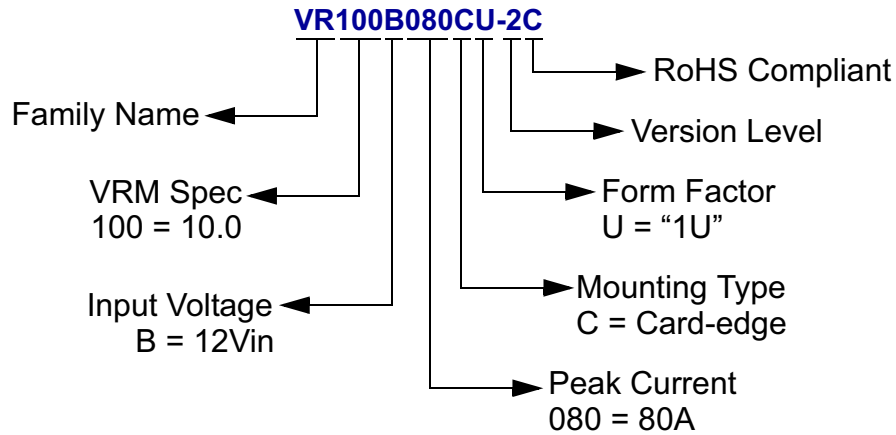

RoHS Compliancy

The VR100B080CU-2C is in compliance with the European Union Directive 2002/95/EC (RoHS) with respect to the following substances: lead (Pb), cadmium (Cd), mercury (Hg), hexavalent chromium, polybrominated biphenyls (PBB) or polybrominated diphenyl ethers (PBDE).

Process Note

This product is not intended to go through a reflow solder process. See recommended interface connector options.