

ELM99xxxB CMOS Middle current voltage regulator

■ General description

ELM99xxxB is CMOS middle current voltage regulator which consists of reference voltage source, error amplifier, low resistance output transistor, short-circuit protection circuit, output voltage setting resistor and chip-enable circuit. ELM99 series is characterized with small input/output voltage difference (with its low resistance output transistor) and high load stability (with its high gain error amplifier). There are 3 types of CE selection of ELM99 series: non-chip enable function, “L” active and “H” active. The standard output voltages are 2.7V, 3.0V, 3.3V, 5.0V; ELM99 series can also be made as semi-custom IC within the range of 1.5V~6.0V by 0.1V step.

■ Features

- Output voltage range : 1.5V~6.0V (by 0.1V)
- Max. output current : 300mA
(Internal current limiter operates when the current exceeds 300mA)
- Stand-by Current consumption : Typ. 0.1 μ A (ELM99xx3B)
- Input stability : Typ. 0.15%/V (ELM9930xB, Iout=40mA)
- Load stability : Typ. 5mV (1mA \leq Iout \leq 100mA)
- Accuracy of output voltage : \pm 2.0%
- Input/Output voltage differential : Typ. 140mV (Vout=3.0V, Iout=40mA)
- Short circuit current limiter : Typ. 70mA (Vout=0V)
- Chip enable pin : “L” active ELM99xx2B
“H” active ELM99xx3B
- Package : SOT-89, SOT-89-5
(SOT-89-5 ones have chip enable function.)

■ Application

- Battery operated devices
- Digital cameras
- Video recorders
- Reference voltage source
- Cell phones

■ Maximum absolute ratings

Parameter	Symbol	Limit	Unit
Input voltage	Vin	12	V
$\overline{\text{CE}}$ /CE Input voltage	Vce	Vss-0.3~Vin+0.3	V
Output voltage	Vout	Vss-0.3~Vin+0.3	V
Output current	Iout	500	mA
Power dissipation	Pd	300 (SOT-89) 500 (SOT-89-5)	mW
Operating temperature	Top	-40~+85	$^{\circ}$ C
Storage temperature	Tstg	-55~+125	$^{\circ}$ C

* Output current must not exceed power dissipation specified in maximum absolute ratings.

ELM99xxxB CMOS Middle current voltage regulator

■ Selection guide

ELM99xxxB-x

Symbol		
a,b	Output voltage	e.g. : 27: Vout=2.7V 30: Vout=3.0V 33: Vout=3.3V 50: Vout=5.0V
c	CE selection	1 : No CE 2: \overline{CE} ="L" active 3: CE="H" active
d	Product version	B
e	Taping direction	S, N : Refer to PKG file

ELM99 x x x B - x
 ↑ ↑ ↑ ↑ ↑
 a b c d e

■ Pin configuration

SOT-89 (TOP VIEW)

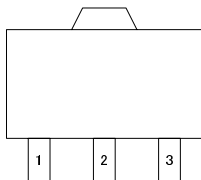

ELM99xx1B

Pin No.	Pin name
1	VSS
2	VIN
3	VOUT

SOT-89-5 (TOP VIEW)

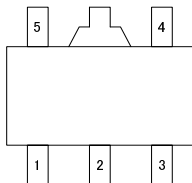

ELM99xx2B

Pin No.	Pin name
1	VSS
2	VIN
3	VOUT
4	NC
5	\overline{CE}

SOT-89-5 (TOP VIEW)

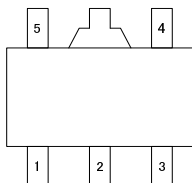

ELM99xx3B

Pin No.	Pin name
1	VSS
2	VIN
3	VOUT
4	NC
5	CE

ELM99xxxB CMOS Middle current voltage regulator

Standard circuit

ELM99xx1B

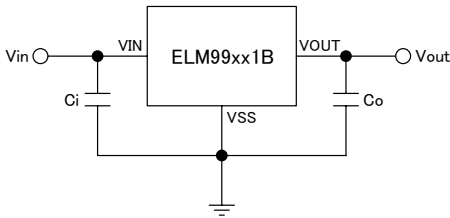

ELM99xx2B: \overline{CE} , ELM99xx3B:CE

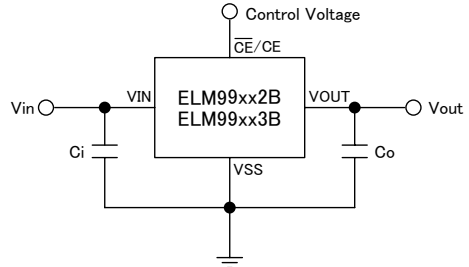

Block diagram

ELM99xx1B

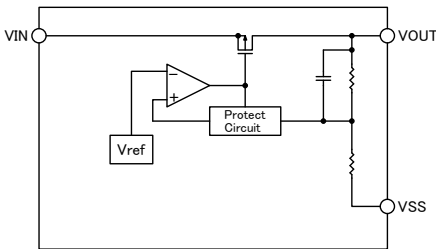

ELM99xx2B: \overline{CE} , ELM99xx3B:CE

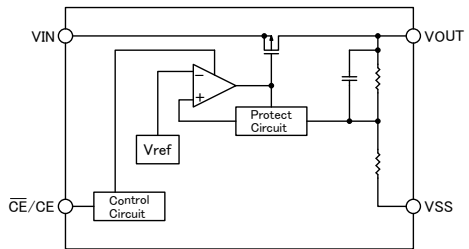

Electrical characteristics (ELM99xx1B)

$V_{out}=2.7V$ (ELM99271B), No CE pin

$T_{op}=25^{\circ}C$

Parameter	Symbol	Condition	Min.	Typ.	Max.	Unit
Output voltage	V_{out}	$V_{in}=3.7V, I_{out}=40mA$	2.646	2.700	2.754	V
Output current	I_{out}	$V_{in}=3.7V$, Lower by 0.1V than V_{out}	150	260		mA
Input stability	$\Delta V_{out} / \Delta V_{in}$	$I_{out}=40mA, 3.7V \leq V_{in} \leq 8.0V$		0.15	0.30	%/V
Load stability	$\Delta V_{out} / \Delta I_{out}$	$1mA \leq I_{out} \leq 100mA, V_{in}=3.7V$		5	15	mV
Input/output voltage differential	V_{dif}	$I_{out}=40mA$		190	320	mV
Current consumption	I_{ss}	$V_{in}=3.7V$, No-load		25	45	μA
Input voltage	V_{in}				8	V
Output voltage temperature coefficient	$\Delta V_{out} / \Delta T_{op}$	$V_{in}=3.7V, I_{out}=40mA, -40^{\circ}C \leq T_{op} \leq +85^{\circ}C$		± 100		ppm/ $^{\circ}C$
Short circuit current	I_{lim}	$V_{out}=0V$		70		mA

ELM99xxxB CMOS Middle current voltage regulator

Vout=3.0V (ELM99301B), No CE pin

Top=25°C

Parameter	Symbol	Condition	Min.	Typ.	Max.	Unit
Output voltage	Vout	Vin=4.0V, Iout=40mA	2.940	3.000	3.060	V
Output current	Iout	Vin=4.0V, Lower by 0.1V than Vout	160	290		mA
Input stability	$\Delta V_{out} / \Delta V_{in}$	Iout=40mA, 4.0V ≤ Vin ≤ 8.0V		0.15	0.30	%/V
Load stability	$\Delta V_{out} / \Delta I_{out}$	1mA ≤ Iout ≤ 100mA, Vin=4.0V		5	15	mV
Input/output voltage differential	Vdif	Iout=40mA		170	275	mV
Current consumption	I _{ss}	Vin=4.0V, No-load		25	45	μA
Input voltage	Vin				8	V
Output voltage temperature coefficient	$\Delta V_{out} / \Delta T_{op}$	Vin=4.0V, Iout=40mA, -40°C ≤ Top ≤ +85°C		±100		ppm/°C
Short circuit current	I _{lim}	Vout=0V		70		mA

Vout=3.3V (ELM99331B), No CE pin

Top=25°C

Parameter	Symbol	Condition	Min.	Typ.	Max.	Unit
Output voltage	Vout	Vin=4.3V, Iout=40mA	3.234	3.300	3.366	V
Output current	Iout	Vin=4.3V, Lower by 0.1V than Vout	170	300		mA
Input stability	$\Delta V_{out} / \Delta V_{in}$	Iout=40mA, 4.3V ≤ Vin ≤ 8.0V		0.15	0.30	%/V
Load stability	$\Delta V_{out} / \Delta I_{out}$	1mA ≤ Iout ≤ 100mA, Vin=4.3V		5	15	mV
Input/output voltage differential	Vdif	Iout=40mA		150	265	mV
Current consumption	I _{ss}	Vin=4.3V, No-load		25	45	μA
Input voltage	Vin				8	V
Output voltage temperature coefficient	$\Delta V_{out} / \Delta T_{op}$	Vin=4.3V, Iout=40mA, -40°C ≤ Top ≤ +85°C		±100		ppm/°C
Short circuit current	I _{lim}	Vout=0V		70		mA

Vout=5.0V (ELM99501B), No CE pin

Top=25°C

Parameter	Symbol	Condition	Min.	Typ.	Max.	Unit
Output voltage	Vout	Vin=6.0V, Iout=40mA	4.900	5.000	5.100	V
Output current	Iout	Vin=6.0V, Lower by 0.1V than Vout	200	330		mA
Input stability	$\Delta V_{out} / \Delta V_{in}$	Iout=40mA, 6.0V ≤ Vin ≤ 8.0V		0.15	0.30	%/V
Load stability	$\Delta V_{out} / \Delta I_{out}$	1mA ≤ Iout ≤ 100mA, Vin=6.0V		5	15	mV
Input/output voltage differential	Vdif	Iout=40mA		125	220	mV
Current consumption	I _{ss}	Vin=6.0V, No-load		30	55	μA
Input voltage	Vin				8	V
Output voltage temperature coefficient	$\Delta V_{out} / \Delta T_{op}$	Vin=6.0V, Iout=40mA, -40°C ≤ Top ≤ +85°C		±100		ppm/°C
Short circuit current	I _{lim}	Vout=0V		70		mA

ELM99xxxB CMOS Middle current voltage regulator

■ Electrical characteristics (ELM99xx2B)

Vout=2.7V (ELM99272B), \overline{CE} ="L" active

Top=25°C

Parameter	Symbol	Condition	Min.	Typ.	Max.	Unit
Output voltage	Vout	Vin=3.7V, Iout=40mA	2.646	2.700	2.754	V
Output current	Iout	Vin=3.7V, Lower by 0.1V than Vout	150	260		mA
Input stability	$\Delta V_{out} / \Delta V_{in}$	Iout=40mA, 3.7V ≤ Vin ≤ 8.0V		0.15	0.30	%/V
Load stability	$\Delta V_{out} / \Delta I_{out}$	1mA ≤ Iout ≤ 100mA, Vin=3.7V		5	15	mV
Input/output voltage differential	Vdif	Iout=40mA		190	320	mV
Current consumption	I _{ss}	Vin=3.7V		25	45	μA
Stand-by current consumption	I _{standby}	Vin=Vce=3.7V		0.005	0.100	μA
Input voltage	Vin				8	V
\overline{CE} Input voltage High	Vceh	Vin=8.0V	1.80		Vin	V
\overline{CE} Input voltage Low	Vcel	Vin=2.0V	0.00		0.25	
\overline{CE} Input current High	Iceh	Vce=Vin		0.0	0.2	μA
\overline{CE} Input current Low	Icel	Vce=Vss	-1.5	-0.4		
Output voltage temperature coefficient	$\Delta V_{out} / \Delta T_{op}$	Vin=3.7V, Iout=40mA, -40°C ≤ Top ≤ +85°C		±100		ppm/°C
Short circuit current	I _{lim}	Vout=0V		70		mA

Vout=3.0V (ELM99302B), \overline{CE} ="L" active

Top=25°C

Parameter	Symbol	Condition	Min.	Typ.	Max.	Unit
Output voltage	Vout	Vin=4.0V, Iout=40mA	2.940	3.000	3.060	V
Output current	Iout	Vin=4.0V, Lower by 0.1V than Vout	160	290		mA
Input stability	$\Delta V_{out} / \Delta V_{in}$	Iout=40mA, 4.0V ≤ Vin ≤ 8.0V		0.15	0.30	%/V
Load stability	$\Delta V_{out} / \Delta I_{out}$	1mA ≤ Iout ≤ 100mA, Vin=4.0V		5	15	mV
Input/output voltage differential	Vdif	Iout=40mA		170	275	mV
Current consumption	I _{ss}	Vin=4.0V		25	45	μA
Stand-by current consumption	I _{standby}	Vin=Vce=4.0V		0.005	0.100	μA
Input voltage	Vin				8	V
\overline{CE} Input voltage High	Vceh	Vin=8.0V	1.80		Vin	V
\overline{CE} Input voltage Low	Vcel	Vin=2.0V	0.00		0.25	
\overline{CE} Input current High	Iceh	Vce=Vin		0.0	0.2	μA
\overline{CE} Input current Low	Icel	Vce=Vss	-1.5	-0.4		
Output voltage temperature coefficient	$\Delta V_{out} / \Delta T_{op}$	Vin=4.0V, Iout=40mA, -40°C ≤ Top ≤ +85°C		±100		ppm/°C
Short circuit current	I _{lim}	Vout=0V		70		mA

ELM99xxxB CMOS Middle current voltage regulator

Vout=3.3V (ELM99332B), \overline{CE} ="L" active

Top=25°C

Parameter	Symbol	Condition	Min.	Typ.	Max.	Unit
Output voltage	Vout	Vin=4.3V, Iout=40mA	3.234	3.300	3.366	V
Output current	Iout	Vin=4.3V, Lower by 0.1V than Vout	170	300		mA
Input stability	$\Delta V_{out} / \Delta V_{in}$	Iout=40mA, 4.3V ≤ Vin ≤ 8.0V		0.15	0.30	%/V
Load stability	$\Delta V_{out} / \Delta I_{out}$	1mA ≤ Iout ≤ 100mA, Vin=4.3V		5	15	mV
Input/output voltage differential	Vdif	Iout=40mA		150	265	mV
Current consumption	I _{ss}	Vin=4.3V		25	45	μA
Stand-by current consumption	I _{standby}	Vin=Vce=4.3V		0.005	0.100	μA
Input voltage	Vin				8	V
\overline{CE} Input voltage High	Vceh	Vin=8.0V	1.80		Vin	V
\overline{CE} Input voltage Low	Vcel	Vin=2.0V	0.00		0.25	
\overline{CE} Input current High	Iceh	Vce=Vin		0.0	0.2	μA
\overline{CE} Input current Low	Icel	Vce=V _{ss}	-1.5	-0.4		
Output voltage temperature coefficient	$\Delta V_{out} / \Delta T_{op}$	Vin=4.3V, Iout=40mA, -40°C ≤ Top ≤ +85°C		±100		ppm/°C
Short circuit current	I _{lim}	Vout=0V		70		mA

Vout=5.0V (ELM99502B), \overline{CE} ="L" active

Top=25°C

Parameter	Symbol	Condition	Min.	Typ.	Max.	Unit
Output voltage	Vout	Vin=6.0V, Iout=40mA	4.900	5.000	5.100	V
Output current	Iout	Vin=6.0V, Lower by 0.1V than Vout	200	330		mA
Input stability	$\Delta V_{out} / \Delta V_{in}$	Iout=40mA, 6.0V ≤ Vin ≤ 8.0V		0.15	0.30	%/V
Load stability	$\Delta V_{out} / \Delta I_{out}$	1mA ≤ Iout ≤ 100mA, Vin=6.0V		5	15	mV
Input/output voltage differential	Vdif	Iout=40mA		125	220	mV
Current consumption	I _{ss}	Vin=6.0V		30	55	μA
Stand-by current consumption	I _{standby}	Vin=Vce=6.0V		0.005	0.100	μA
Input voltage	Vin				8	V
\overline{CE} Input voltage High	Vceh	Vin=8.0V	1.80		Vin	V
\overline{CE} Input voltage Low	Vcel	Vin=2.0V	0.00		0.25	
\overline{CE} Input current High	Iceh	Vce=Vin		0.0	0.2	μA
\overline{CE} Input current Low	Icel	Vce=V _{ss}	-1.5	-0.4		
Output voltage temperature coefficient	$\Delta V_{out} / \Delta T_{op}$	Vin=6.0V, Iout=40mA, -40°C ≤ Top ≤ +85°C		±100		ppm/°C
Short circuit current	I _{lim}	Vout=0V		70		mA

ELM99xxxB CMOS Middle current voltage regulator

■ Electrical characteristics (ELM99xx3B)

Vout=2.7V (ELM99273B), CE="H" active

Top=25°C

Parameter	Symbol	Condition	Min.	Typ.	Max.	Unit
Output voltage	Vout	Vin=3.7V, Iout=40mA	2.646	2.700	2.754	V
Output current	Iout	Vin=3.7V, Lower by 0.1V than Vout	150	260		mA
Input stability	$\Delta V_{out} / \Delta V_{in}$	Iout=40mA, 3.7V ≤ Vin ≤ 8.0V		0.15	0.30	%/V
Load stability	$\Delta V_{out} / \Delta I_{out}$	1mA ≤ Iout ≤ 100mA, Vin=3.7V		5	15	mV
Input/output voltage differential	Vdif	Iout=40mA		190	320	mV
Current consumption	I _{ss}	Vin=3.7V		25	45	μA
Stand-by current consumption	I _{standby}	Vin=3.7V, Vce=Vss		0.1	0.5	μA
Input voltage	Vin				8	V
CE Input voltage High	Vceh	Vin=8.0V	1.80		Vin	V
CE Input voltage Low	Vcel	Vin=2.0V	0.00		0.25	
CE Input current High	Iceh	Vce=Vin		0.4	1.5	μA
CE Input current Low	Icel	Vce=Vss	-0.2	0.0		
Output voltage temperature coefficient	$\Delta V_{out} / \Delta T_{op}$	Vin=3.7V, Iout=40mA, -40°C ≤ Top ≤ +85°C		±100		ppm/°C
Short circuit current	I _{lim}	Vout=0V		70		mA

Vout=3.0V (ELM99303B), CE="H" active

Top=25°C

Parameter	Symbol	Condition	Min.	Typ.	Max.	Unit
Output voltage	Vout	Vin=4.0V, Iout=40mA	2.940	3.000	3.060	V
Output current	Iout	Vin=4.0V, Lower by 0.1V than Vout	160	290		mA
Input stability	$\Delta V_{out} / \Delta V_{in}$	Iout=40mA, 4.0V ≤ Vin ≤ 8.0V		0.15	0.30	%/V
Load stability	$\Delta V_{out} / \Delta I_{out}$	1mA ≤ Iout ≤ 100mA, Vin=4.0V		5	15	mV
Input/output voltage differential	Vdif	Iout=40mA		170	275	mV
Current consumption	I _{ss}	Vin=4.0V		25	45	μA
Stand-by current consumption	I _{standby}	Vin=4.0V, Vce=Vss		0.1	0.5	μA
Input voltage	Vin				8	V
CE Input voltage High	Vceh	Vin=8.0V	1.80		Vin	V
CE Input voltage Low	Vcel	Vin=2.0V	0.00		0.25	
CE Input current High	Iceh	Vce=Vin		0.4	1.5	μA
CE Input current Low	Icel	Vce=Vss	-0.2	0.0		
Output voltage temperature coefficient	$\Delta V_{out} / \Delta T_{op}$	Vin=4.0V, Iout=40mA, -40°C ≤ Top ≤ +85°C		±100		ppm/°C
Short circuit current	I _{lim}	Vout=0V		70		mA

ELM99xxxB CMOS Middle current voltage regulator

Vout=3.3V (ELM99333B), CE="H" active

Top=25°C

Parameter	Symbol	Condition	Min.	Typ.	Max.	Unit
Output voltage	Vout	Vin=4.3V, Iout=40mA	3.234	3.300	3.366	V
Output current	Iout	Vin=4.3V, Lower by 0.1V than Vout	170	300		mA
Input stability	$\Delta V_{out} / \Delta V_{in}$	Iout=40mA, 4.3V ≤ Vin ≤ 8.0V		0.15	0.30	%/V
Load stability	$\Delta V_{out} / \Delta I_{out}$	1mA ≤ Iout ≤ 100mA, Vin=4.3V		5	15	mV
Input/output voltage differential	Vdif	Iout=40mA		150	265	mV
Current consumption	I _{ss}	Vin=4.3V		25	45	μA
Stand-by current consumption	I _{standby}	Vin=4.3V, Vce=Vss		0.1	0.5	μA
Input voltage	Vin				8	V
CE Input voltage High	Vceh	Vin=8.0V	1.80		Vin	V
CE Input voltage Low	Vcel	Vin=2.0V	0.00		0.25	
CE Input current High	Iceh	Vce=Vin		0.4	1.5	μA
CE Input current Low	Icel	Vce=Vss	-0.2	0.0		
Output voltage temperature coefficient	$\Delta V_{out} / \Delta T_{op}$	Vin=4.3V, Iout=40mA, -40°C ≤ Top ≤ +85°C		±100		ppm/°C
Short circuit current	I _{lim}	Vout=0V		70		mA

Vout=5.0V (ELM99503B), CE="H" active

Top=25°C

Parameter	Symbol	Condition	Min.	Typ.	Max.	Unit
Output voltage	Vout	Vin=6.0V, Iout=40mA	4.900	5.000	5.100	V
Output current	Iout	Vin=6.0V, Lower by 0.1V than Vout	200	330		mA
Input stability	$\Delta V_{out} / \Delta V_{in}$	Iout=40mA, 6.0V ≤ Vin ≤ 8.0V		0.15	0.30	%/V
Load stability	$\Delta V_{out} / \Delta I_{out}$	1mA ≤ Iout ≤ 100mA, Vin=6.0V		5	15	mV
Input/output voltage differential	Vdif	Iout=40mA		125	220	mV
Current consumption	I _{ss}	Vin=6.0V		30	55	μA
Stand-by current consumption	I _{standby}	Vin=6.0V, Vce=Vss		0.1	0.5	μA
Input voltage	Vin				8	V
CE Input voltage High	Vceh	Vin=8.0V	1.80		Vin	V
CE Input voltage Low	Vcel	Vin=2.0V	0.00		0.25	
CE Input current High	Iceh	Vce=Vin		0.4	1.5	μA
CE Input current Low	Icel	Vce=Vss	-0.2	0.0		
Output voltage temperature coefficient	$\Delta V_{out} / \Delta T_{op}$	Vin=6.0V, Iout=40mA, -40°C ≤ Top ≤ +85°C		±100		ppm/°C
Short circuit current	I _{lim}	Vout=0V		70		mA

■ Marking

SOT-89

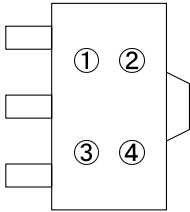

• SOT-89 package : ELM99xx1B

No. ① : the integer digit of the output voltage

Mark	Vout	Mark	Vout
A	2.*V	D	5.*V
B	3.*V	E	6.*V
C	4.*V	F	1.*V

No. ② : the decimal digit of the output voltage

Mark	Vout	Mark	Vout
A	*.0V	F	*.5V
B	*.1V	G	*.6V
C	*.2V	H	*.7V
D	*.3V	J	*.8V
E	*.4V	K	*.9V

No. ③ : Assembly lot No.

A~Z (I, O, X excepted)

No. ④ : Assembly lot No.

0~9

SOT-89-5

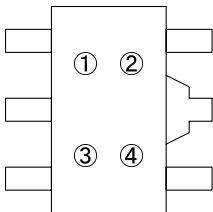

• SOT-89-5 package : ELM99xx2B, ELM99xx3B with CE

No. ① : the integer digit of the output voltage

ELM99xx2B

Mark	Vout	Mark	Vout
F	2.*V	J	5.*V
G	3.*V	K	6.*V
H	4.*V	S	1.*V

ELM99xx3B

Mark	Vout	Mark	Vout
L	2.*V	P	5.*V
M	3.*V	Q	6.*V
N	4.*V	T	1.*V

No. ② : the decimal digit of the output voltage

ELM99xx2B, ELM99xx3B

Mark	Vout	Mark	Vout
A	*.0V	F	*.5V
B	*.1V	G	*.6V
C	*.2V	H	*.7V
D	*.3V	J	*.8V
E	*.4V	K	*.9V

No. ③ : Assembly lot No.

A~Z (I, O, X excepted)

No. ④ : Assembly lot No.

0~9

■ Typical characteristics

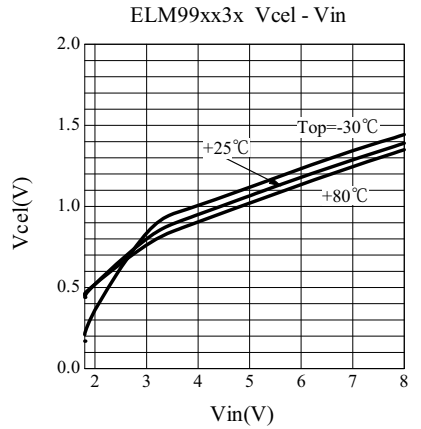
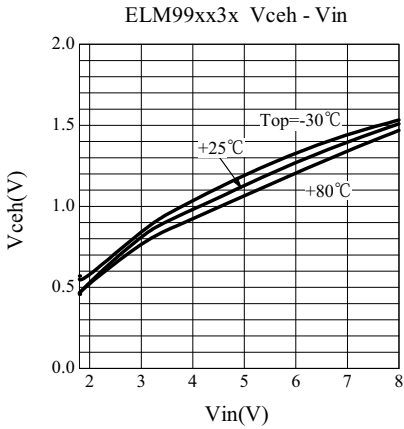
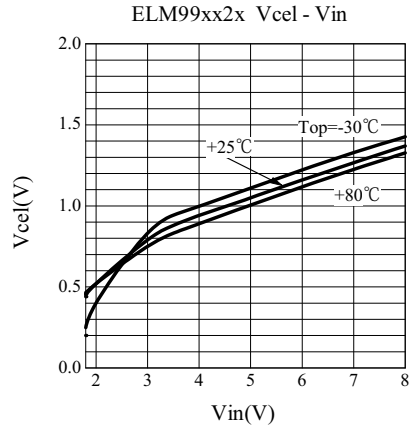
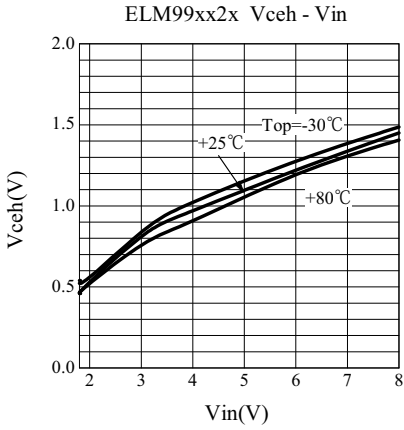

ELM99xxxB CMOS Middle current voltage regulator

- $V_{out}=2.7V$ (ELM9927xB)

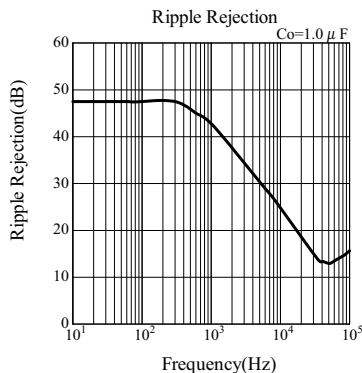
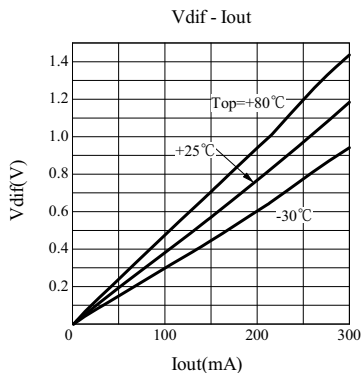
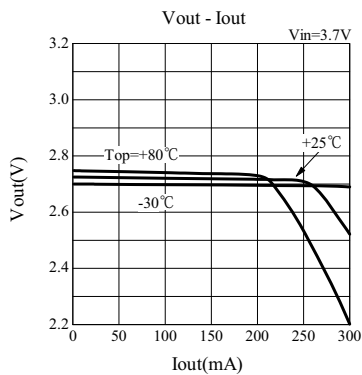
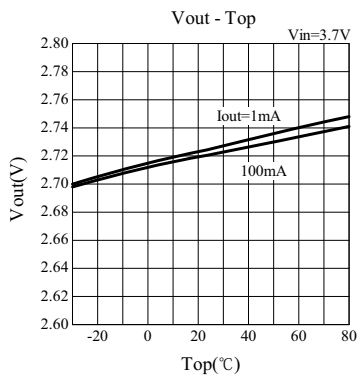
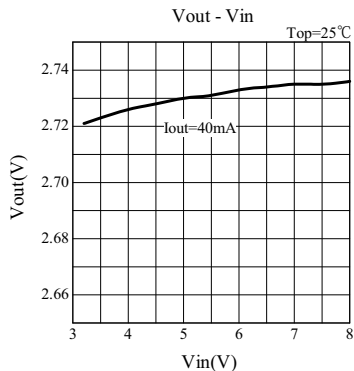
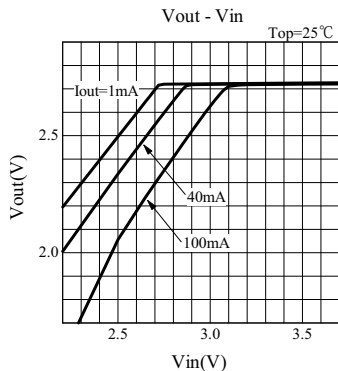

ELM99xxxB CMOS Middle current voltage regulator

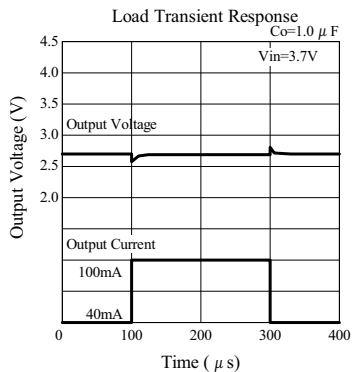
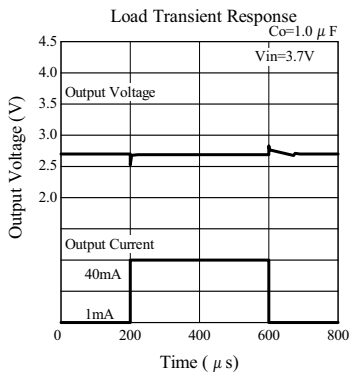
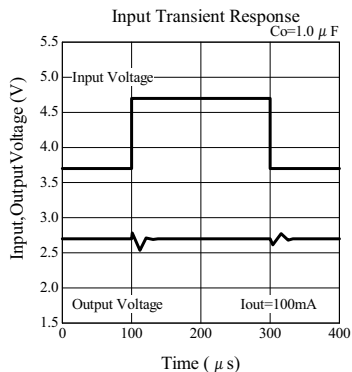
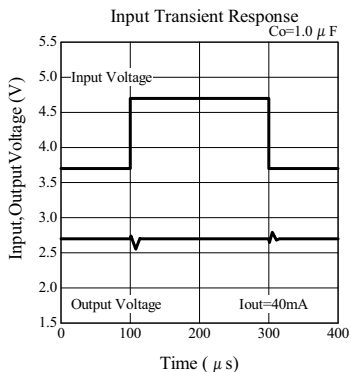
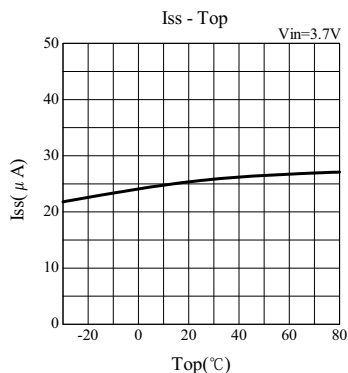
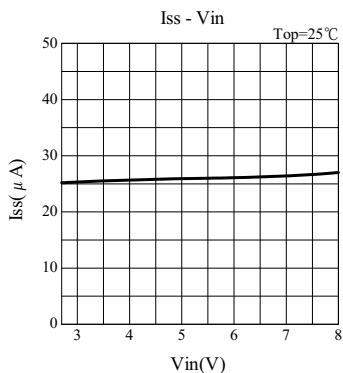

ELM99xxxB CMOS Middle current voltage regulator

- $V_{out}=3.0V$ (ELM9930xB)

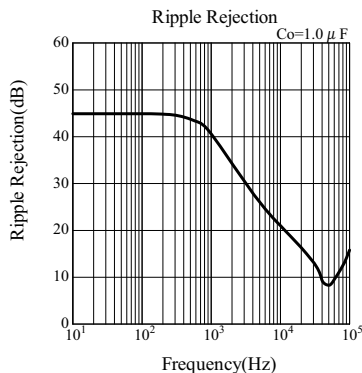
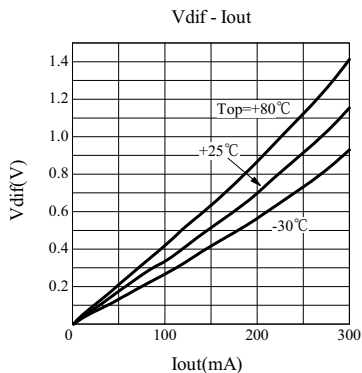
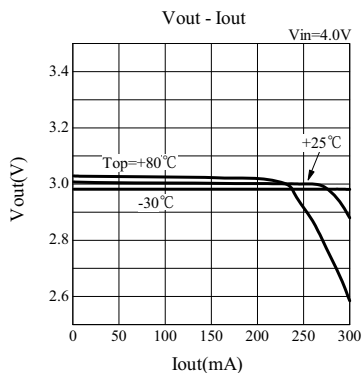
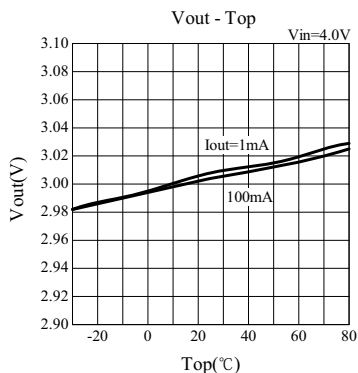
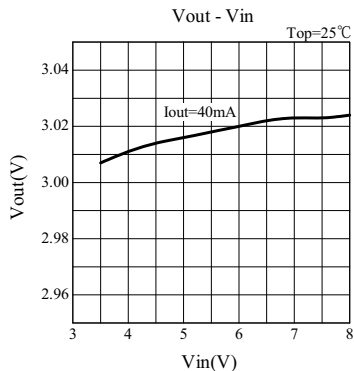
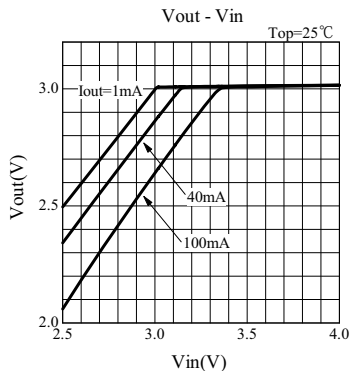

ELM99xxxB CMOS Middle current voltage regulator

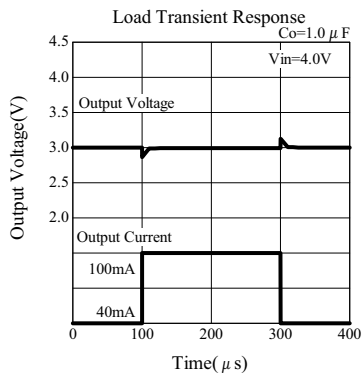
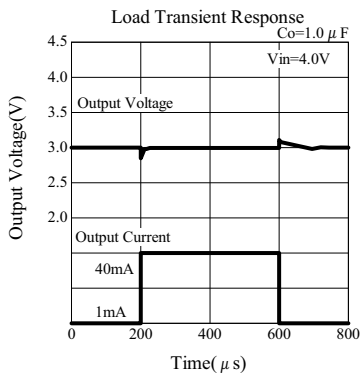
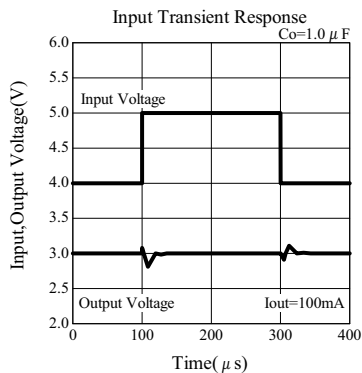
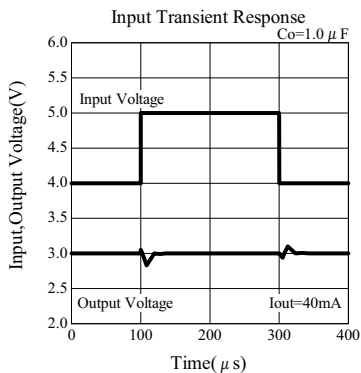
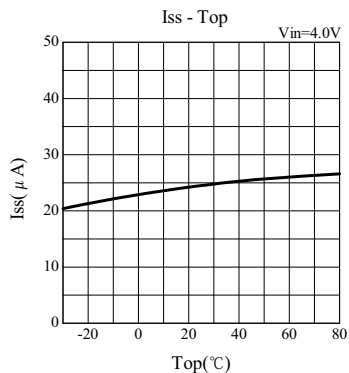
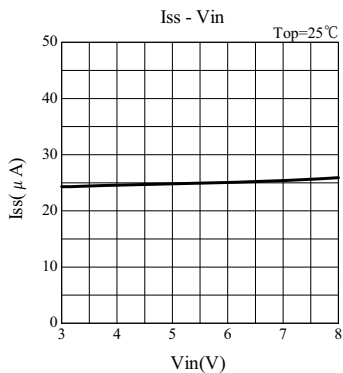

ELM99xxxB CMOS Middle current voltage regulator

- $V_{out}=3.3V$ (ELM9933xB)

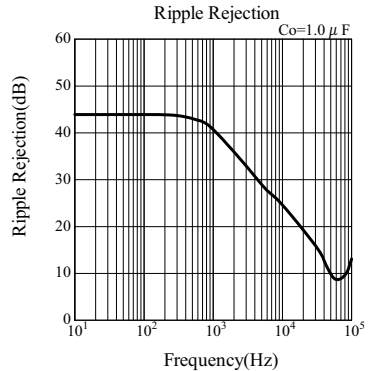
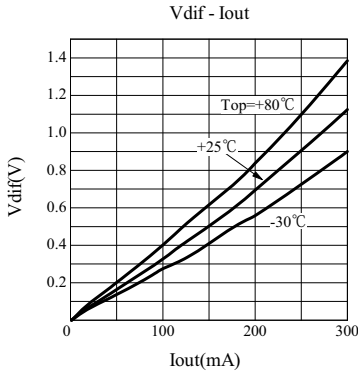
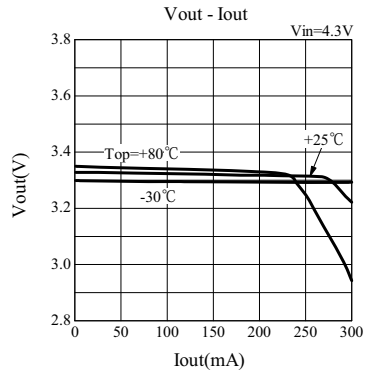
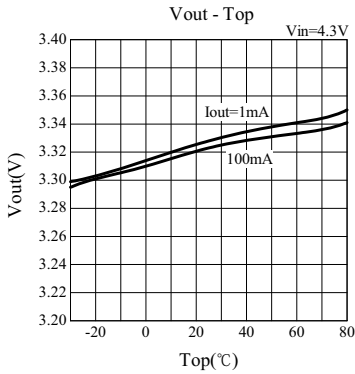
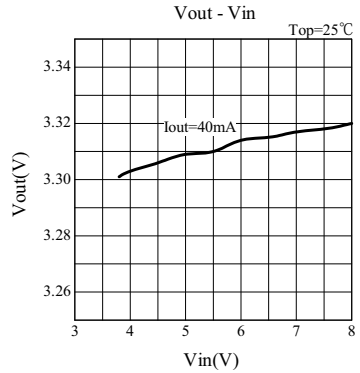
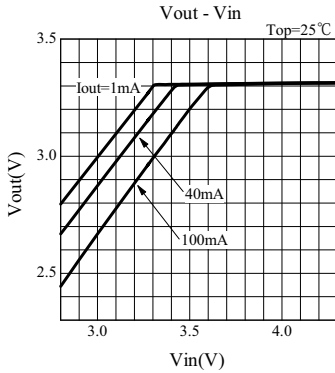

ELM99xxxB CMOS Middle current voltage regulator

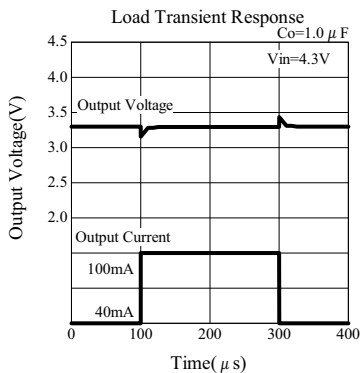
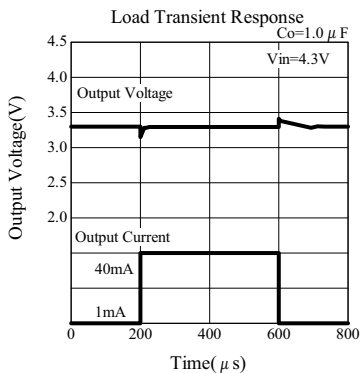
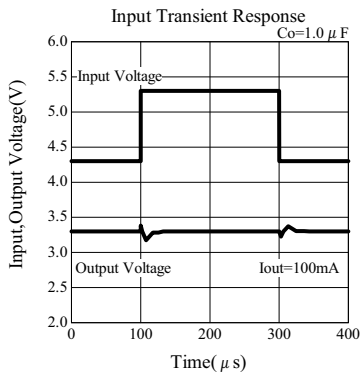
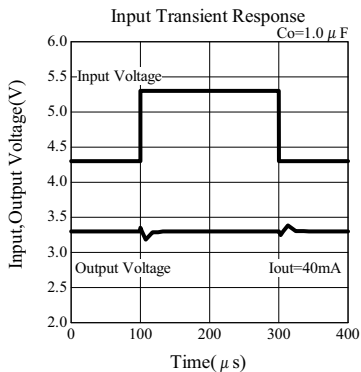
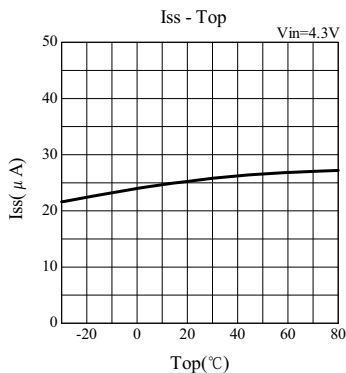
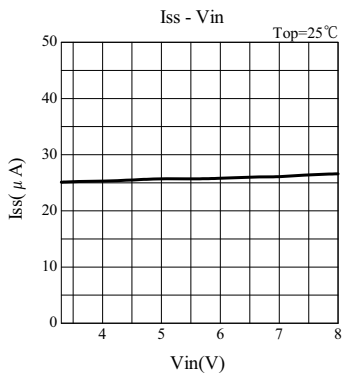

ELM99xxxB CMOS Middle current voltage regulator

- $V_{out}=5.0V$ (ELM9950xB)

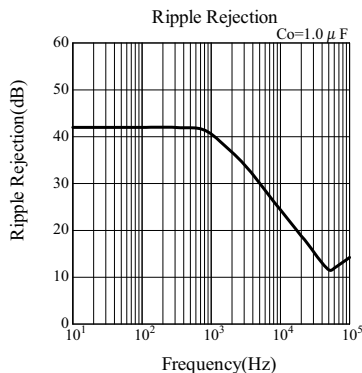
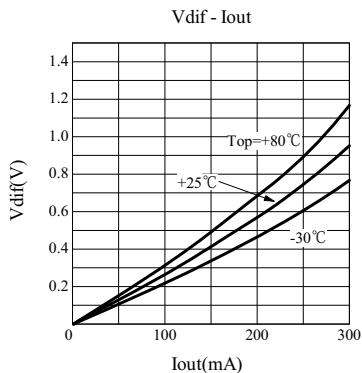
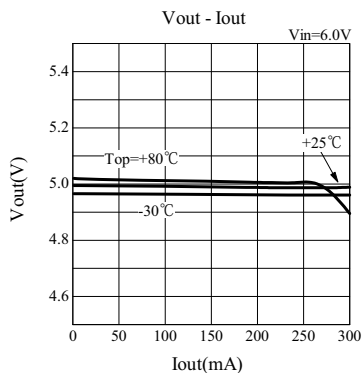
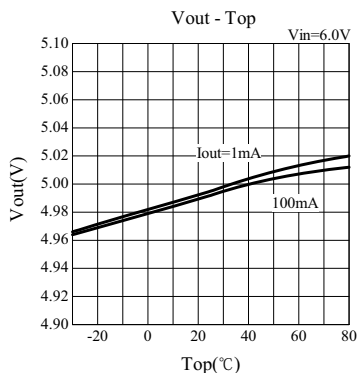
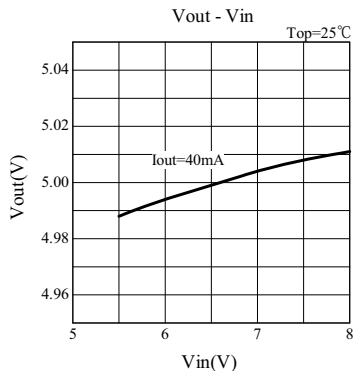
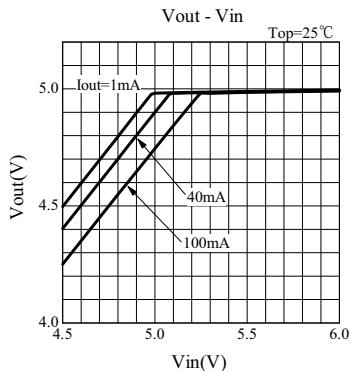

ELM99xxxB CMOS Middle current voltage regulator

