

PCB terminal block - KDSP 1,5/ 3 - 1780895

Please be informed that the data shown in this PDF Document is generated from our Online Catalog. Please find the complete data in the user's documentation. Our General Terms of Use for Downloads are valid (<http://phoenixcontact.com/download>)

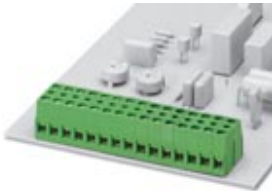

PCB terminal block, Nominal current: 17.5 A, Nom. voltage: 400 V, Pitch: 5 mm, Number of positions: 3, Connection method: Screw connection, Mounting: Soldering, Conductor/PCB connection direction: 0 °, Color: green, The article can be aligned to create different nos. of positions!

The illustration shows a combination as a 15-position version



Key commercial data

Packing unit	1 pc
GTIN	 4 017918 040932
Weight per Piece (excluding packing)	9.03 GRM
Custom tariff number	85369010
Country of origin	Poland

Technical data

Dimensions

Length	18.8 mm
Pitch	5 mm
Dimension a	10 mm
Pin dimensions	0,9 x 0,9 mm
Hole diameter	1.3 mm

General

Range of articles	KDSP 1,5
Insulating material group	I
Rated surge voltage (III/3)	4 kV
Rated surge voltage (III/2)	4 kV
Rated surge voltage (II/2)	4 kV

PCB terminal block - KDSP 1,5/ 3 - 1780895

Technical data

General

Rated voltage (III/3)	320 V
Rated voltage (III/2)	400 V
Rated voltage (II/2)	630 V
Connection in acc. with standard	EN-VDE
Nominal current I_N	17.5 A
Nominal cross section	1.5 mm ²
Maximum load current	17.5 A (with 1.5 mm ² conductor cross section)
Insulating material	PA
Solder pin surface	Sn
Inflammability class according to UL 94	V2
Internal cylindrical gage	A 1
Stripping length	7 mm
Number of positions	3
Screw thread	M3
Tightening torque, min	0.6 Nm
Tightening torque max	0.8 Nm

Connection data

Conductor cross section solid min.	0.14 mm ²
Conductor cross section solid max.	1.5 mm ²
Conductor cross section stranded min.	0.14 mm ²
Conductor cross section stranded max.	1.5 mm ²
Conductor cross section stranded, with ferrule without plastic sleeve min.	0.25 mm ²
Conductor cross section stranded, with ferrule without plastic sleeve max.	1.5 mm ²
Conductor cross section stranded, with ferrule with plastic sleeve min.	0.25 mm ²
Conductor cross section stranded, with ferrule with plastic sleeve max.	1.5 mm ²
Conductor cross section AWG/kcmil min.	26
Conductor cross section AWG/kcmil max	16
2 conductors with same cross section, solid min.	0.14 mm ²
2 conductors with same cross section, solid max.	0.75 mm ²
2 conductors with same cross section, stranded min.	0.14 mm ²
2 conductors with same cross section, stranded max.	0.5 mm ²
2 conductors with same cross section, stranded, ferrules without plastic sleeve, min.	0.25 mm ²
2 conductors with same cross section, stranded, TWIN ferrules with plastic sleeve, min.	0.5 mm ²
2 conductors with same cross section, stranded, TWIN ferrules with plastic sleeve, max.	1 mm ²
Minimum AWG according to UL/CUL	30

PCB terminal block - KDSP 1,5/ 3 - 1780895

Technical data

Connection data

Maximum AWG according to UL/CUL	14
---------------------------------	----

Classifications

eCl@ss

eCl@ss 4.0	27141109
eCl@ss 4.1	27141109
eCl@ss 5.0	27141190
eCl@ss 5.1	27141190
eCl@ss 6.0	27261101
eCl@ss 7.0	27440401
eCl@ss 8.0	27440401

ETIM

ETIM 3.0	EC001121
ETIM 4.0	EC002643
ETIM 5.0	EC002643

UNSPSC

UNSPSC 6.01	30211801
UNSPSC 7.0901	39121432
UNSPSC 11	39121432
UNSPSC 12.01	39121432
UNSPSC 13.2	39121432

Approvals

Approvals

Approvals

CSA / UL Recognized / cUL Recognized / GOST / GOST / cULus Recognized

Ex Approvals

Approvals submitted

PCB terminal block - KDSP 1,5/ 3 - 1780895

Approvals

Approval details

CSA 	
mm ² /AWG/kcmil	28-14
Nominal current I _N	10 A
Nominal voltage U _N	300 V

UL Recognized 		
	B	D
mm ² /AWG/kcmil	30-14	30-14
Nominal current I _N	15 A	10 A
Nominal voltage U _N	300 V	300 V

cUL Recognized 		
	B	D
mm ² /AWG/kcmil	30-14	30-14
Nominal current I _N	15 A	10 A
Nominal voltage U _N	300 V	300 V

GOST 	
--	--

GOST 	
--	--

cULus Recognized 	
--	--

Drawings

PCB terminal block - KDSP 1,5/ 3 - 1780895

Drilling diagram

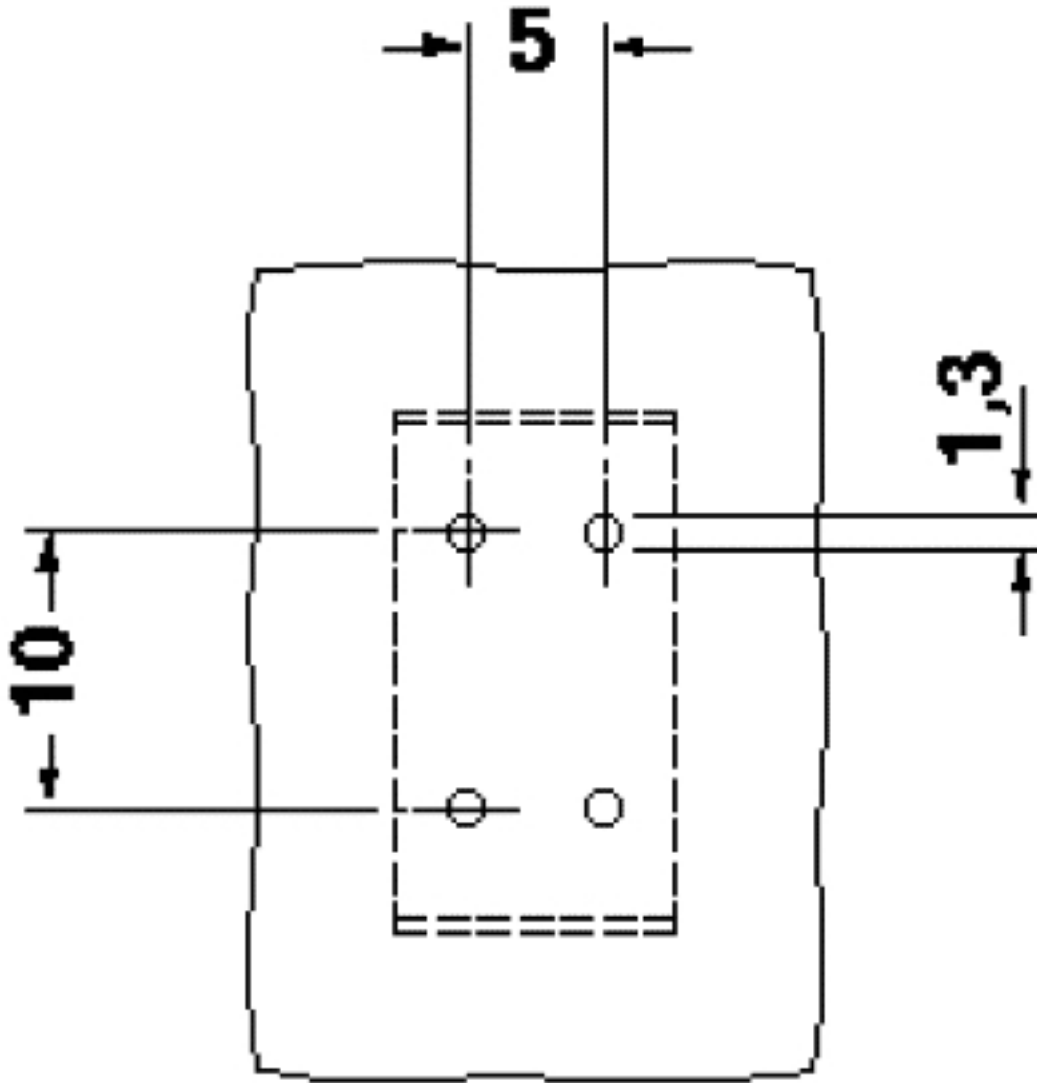

PCB terminal block - KDSP 1,5/ 3 - 1780895

Dimensioned drawing

