

**Z00607MA
Z00607DA**
SENSITIVE GATE TRIACS

FEATURES

- $I_{T(RMS)} = 0.8A$
- $V_{DRM} = 400V$ and $600V$
- $I_{GT} = 5mA$

DESCRIPTION

The Z006607xA triacs are intended for general applications where high gate sensitivity is required.

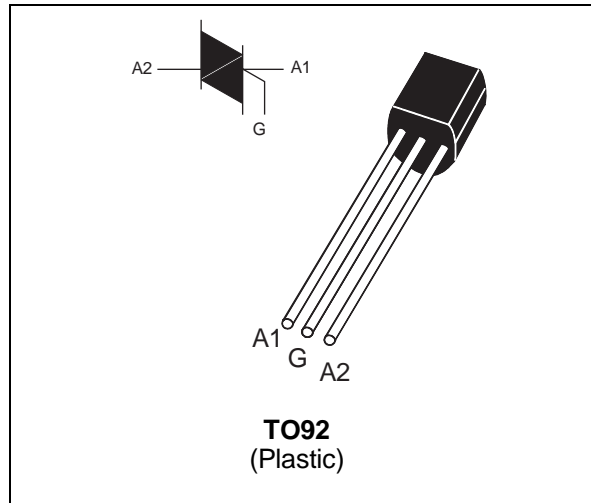

ABSOLUTE RATINGS (limiting values)

Symbol	Parameter		Value	Unit
$I_{T(RMS)}$	RMS on-state current (360° conduction angle)	$T_I = 50\text{ °C}$	0.8	A
I_{TSM}	Non repetitive surge peak on-state current (T_j initial = 25°C)	$t_p = 8.3\text{ ms}$	10.5	A
		$t_p = 10\text{ ms}$	10	
	Non repetitive surge peak on-state current (T_j initial = 110°C, full cycle)	$F = 60\text{ Hz}$	8	
I^2t	I^2t Value for fusing	$t_p = 10\text{ ms}$	0.5	A^2s
T_{stg} T_j	Storage and operating junction temperature range		- 40, + 150 - 40, + 110	°C
T_I	Maximum lead temperature for soldering during 10s		260	°C

Symbol	Parameter	Z00607xA		Unit
		D	M	
V_{DRM} V_{RRM}	Repetitive peak off-state voltage $T_j = 110\text{ °C}$	400	600	V

Z00607DA / Z00607MA

THERMAL RESISTANCES

Symbol	Parameter	Value	Unit
Rth(j-a)	Junction to ambient	150	°C/W
Rth(j-l)	Junction to lead	60	°C/W

GATE CHARACTERISTICS (maximum values)

$P_{G(AV)} = 0.1 \text{ W}$ $P_{GM} = 2 \text{ W}$ ($t_p = 20 \mu\text{s}$) $I_{GM} = 1 \text{ A}$ ($t_p = 20 \mu\text{s}$)

ELECTRICAL CHARACTERISTICS

Symbol	Test Conditions	Quadrant		Sensitivity		Unit
				07		
I_{GT}	$V_D = 12\text{V (DC)}$ $R_L = 140\Omega$ $T_j = 25^\circ\text{C}$	I-II-III	MAX	5		mA
		IV	MAX	7		
V_{GT}	$V_D = 12\text{V (DC)}$ $R_L = 140\Omega$ $T_j = 25^\circ\text{C}$	I-II-III-IV	MAX	1.5		V
V_{GD}	$V_D = V_{DRM}$ $R_L = 3.3\text{k}\Omega$ $T_j = 110^\circ\text{C}$	I-II-III-IV	MIN	0.2		V
tgt	$V_D = V_{DRM}$ $I_G = 25\text{mA}$ $I_T = 1.0\text{A}$ $dI_G/dt = 0.25\text{A}/\mu\text{s}$ $T_j = 25^\circ\text{C}$	I-II-III-IV	TYP	2		μs
I_H^*	$I_T = 200 \text{ mA}$ Gate open $T_j = 25^\circ\text{C}$		MAX	5		mA
I_L	$I_G = 1.2 I_{GT}$ $T_j = 25^\circ\text{C}$	I-III-IV	MAX	10		mA
		II	MAX	20		
V_{TM}^*	$I_{TM} = 1.1\text{A}$ $t_p = 380\mu\text{s}$ $T_j = 25^\circ\text{C}$		MAX	1.5		V
I_{DRM} I_{RRM}	$V_D = V_{DRM}$ $T_j = 25^\circ\text{C}$		MAX	10		μA
	$V_R = V_{RRM}$ $T_j = 110^\circ\text{C}$		MAX	0.1		mA
dV/dt *	$V_D = 67\% V_{DRM}$ Gate open $T_j = 110^\circ\text{C}$		MIN	10		V/ μs
(dV/dt)c *	(dI/dt)c = 0.35 A/ms $T_j = 110^\circ\text{C}$		MIN	1.5		V/ μs

* For either polarity of electrode A₂ voltage with reference to electrode A₁

Fig 1: Maximum power dissipation versus RMS on-state current.

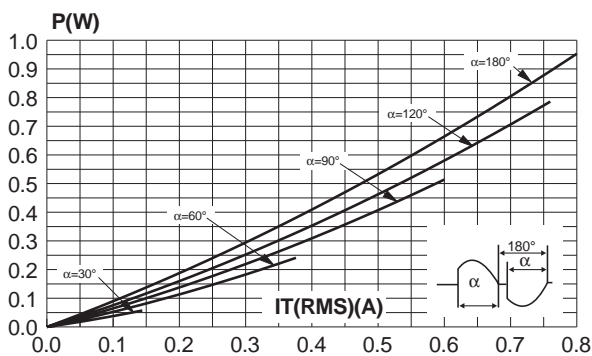

Fig 2: Correlation between maximum power dissipation and maximum allowable temperatures (Tamb and Tlead).

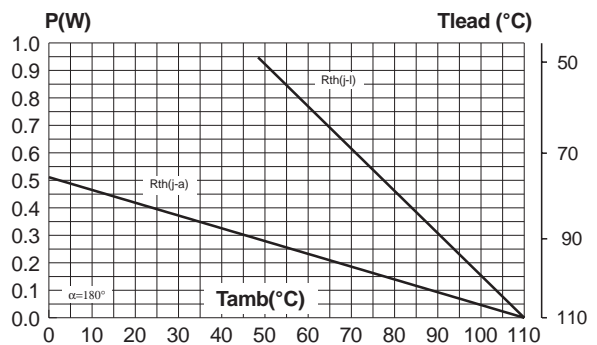

Fig 3: RMS on-state current versus ambient temperature.

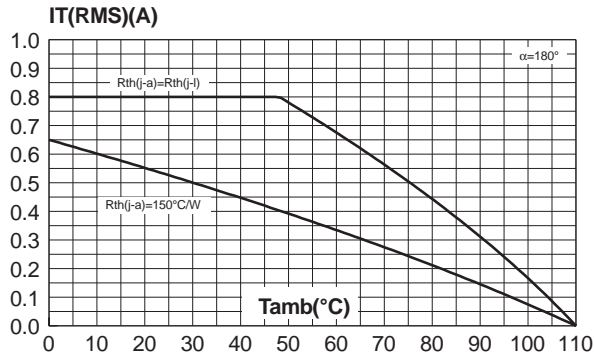

Fig 4: Relative variation of thermal impedance junction to ambient versus pulse duration.

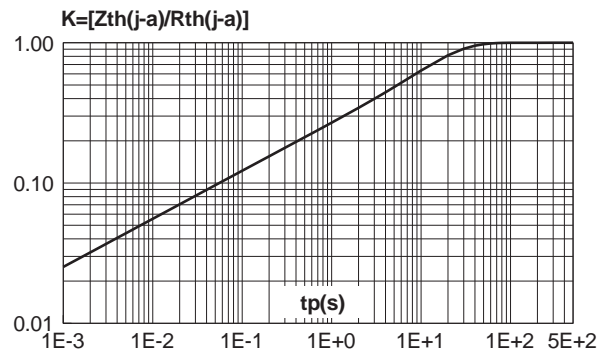

Fig 5: Relative variation of gate trigger current and holding current versus junction temperature (typical values).

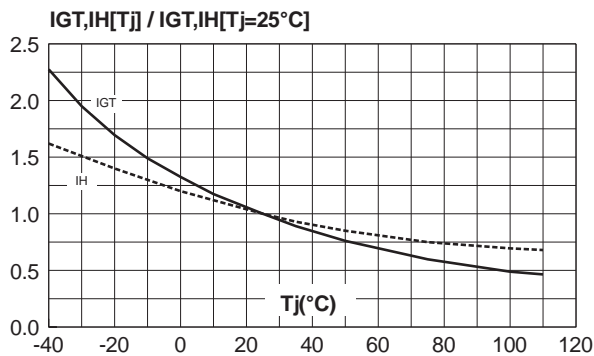

Fig 6: Non repetitive surge peak on-state current versus number of cycles.

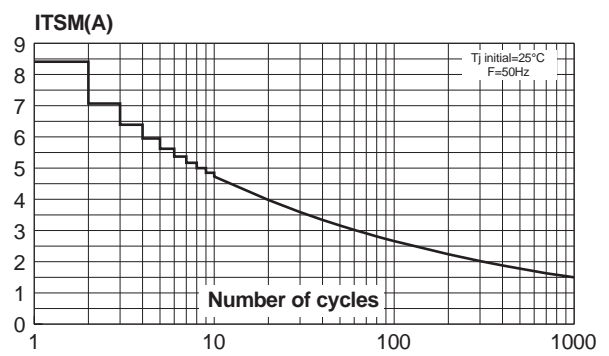

Fig 7: Non repetitive surge peak on-state current for a sinusoidal pulse with width $tp < 10ms$, and corresponding value of I^2t .

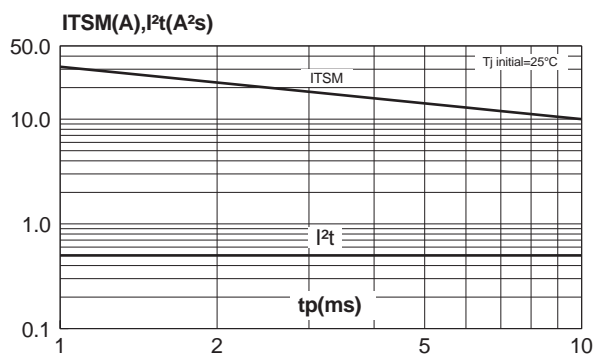
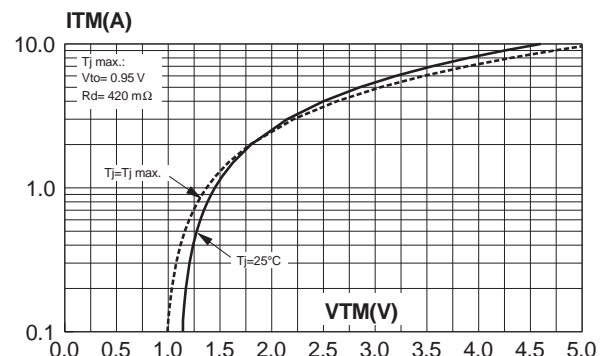

Fig 8: On-state characteristics (maximum values).



Z00607DA / Z00607MA

PACKAGE MECHANICAL DATA

TO92 (Plastic)

REF.	DIMENSIONS					
	Millimeters			Inches		
	Typ.	Min.	Max.	Typ.	Min.	Max.
A	1.35			0.053		
B			4.70			0.185
C	2.54			0.100		
D		4.40			0.173	
E		12.70			0.500	
F			3.70			0.146
a			0.45			0.017

Ordering type	Marking	Package	Weight	Base qty	Delivery mode
Z00607DA 1BA2	Z0607DA	TO92	0.2g.	2500	Bulk
Z00607MA 1BA2	Z0607MA	TO92	0.2g.	2500	Bulk