

To all our customers

---

## **Regarding the change of names mentioned in the document, such as Mitsubishi Electric and Mitsubishi XX, to Renesas Technology Corp.**

---

The semiconductor operations of Hitachi and Mitsubishi Electric were transferred to Renesas Technology Corporation on April 1st 2003. These operations include microcomputer, logic, analog and discrete devices, and memory chips other than DRAMs (flash memory, SRAMs etc.) Accordingly, although Mitsubishi Electric, Mitsubishi Electric Corporation, Mitsubishi Semiconductors, and other Mitsubishi brand names are mentioned in the document, these names have in fact all been changed to Renesas Technology Corp. Thank you for your understanding. Except for our corporate trademark, logo and corporate statement, no changes whatsoever have been made to the contents of the document, and these changes do not constitute any alteration to the contents of the document itself.

Note : Mitsubishi Electric will continue the business operations of high frequency & optical devices and power devices.

Renesas Technology Corp.  
Customer Support Dept.  
April 1, 2003

**M52317SP**

MULTIPLE SIF CONVERTER

**DESCRIPTION**

M52317SP integrated circuit processes multiple-standard sound signals of intermediate frequencies for TV and VCR. The processing of sound intermediate frequency signals of various standards has conventionally been complicated, however, it can be simplified by using this IC.

**FEATURES**

- This IC converts 4.5~6.5MHz SIF signals to 6.0MHz with deviation of  $\pm 50\text{kHz}$ , being interlocked with a video trap selector switch.
- In the manual mode, a filter and trap can be connected for signals of each frequency level, ensuring good sound sensitivity and allowing great freedom in sound trap processing.
- In the automatic mode, 5.5~6.5MHz signals are converted to 6 MHz all together, therefore, the sound sensitivity is slightly lower than in the manual mode. The trap switch is locked to the 5.5MHz position, and the traps for 5.5~6.5MHz signals are used being connected in series. Signals of 4.5MHz cannot be converted in the automatic mode. Switch the control mode to convert them.
- The 4.5MHz switch output is provided to switch the VIF band and other factors. This output is in the open collector form.
- With a built-in stabilizing power supply, this IC can be used at supply voltage of 5V and 9~12V.
- Enclosed in a space-saving 20pin shrink double inline package.

**APPLICATION**

Color TV and VCR

**PIN CONFIGURATION (TOP VIEW)**

VIDEO 5.5M-IN	1	20	VIDEO OUT
VIDEO 6.0M-IN	2	19	V <sub>CC1</sub>
VIDEO 6.5M-IN	3	18	V <sub>CC2</sub>
4.5M-SW(LO)	4	17	4.5M-IN
VIDEO 4.5M-IN	5	16	GND
4.5M-SW(OPEN)	6	15	6.0M-IN
OSC	7	14	CONTROL S2
OSC V <sub>CC</sub>	8	13	5.5M-IN
SIF 6.0M-OUT	9	12	CONTROL S1
CONTROL S3	10	11	6.5M-IN

Outline 20P4B

**RECOMMENDED OPERATING CONDITION**

Supply voltage range

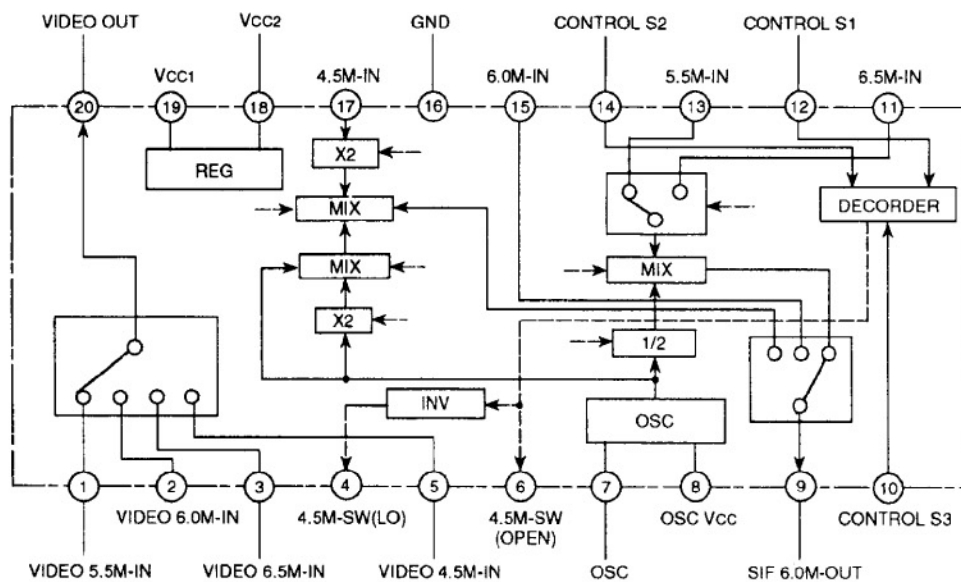
.....4.5~5.5V(when V<sub>CC1</sub>,V<sub>CC2</sub> are short-circuited)8.5~12.5V(V<sub>CC1</sub> voltage when V<sub>CC1</sub> and V<sub>CC2</sub> are open)Recommended supply voltage range .....5.0V(when V<sub>CC1</sub>,  
V<sub>CC2</sub> are short-circuited)**BLOCK DIAGRAM**

## ABSOLUTE MAXIMUM RATINGS

Symbol	Parameter	Ratings	Unit
V <sub>CC1</sub>	Supply voltage 1	13	V
V <sub>CC2</sub>	Supply voltage 2	6	V
P <sub>d</sub>	Power dissipation	1000	mW
T <sub>opr</sub>	Operating temperature	-20~+75	°C
T <sub>stg</sub>	Storage temperature	-40~+125	°C
Surge	Electrostatic discharge	±200	V

ELECTRICAL CHARACTERISTICS (T<sub>a</sub>=25°C unless otherwise noted; test circuit 1)

Symbol	Parameter	Test point	Input		V <sub>CC</sub>	SW		External power supply							Limits			Unit
			Input point	SG		S18	S19	V1	V2	V3	V5	V10	V12	V14	Min.	Typ.	Max.	
I <sub>CC1</sub>	Circuit current 1	A	-	-	5	ON	OFF	-	-	-	-	5	5	5	10	20	30	mA
I <sub>CC2</sub>	Circuit current 2	A	-	-	5	ON	OFF	-	-	-	-	0	0	0	12	22	32	mA
V <sub>CC2</sub>	V <sub>CC2</sub> voltage	TP18	-	-	12	OFF	ON	-	-	-	-	0	0	0	4.6	5.1	5.6	V
G <sub>6.5M</sub>	6.5MHz gain	TP9	11	1	5	ON	ON	-	-	-	-	0	5	5	-2	0	2	dB
G <sub>6.0M</sub>	6.0MHz gain	TP9	15	2	5	ON	ON	-	-	-	-	0	5	0	-5	-3	-1	dB
G <sub>5.5M</sub>	5.5MHz gain	TP9	13	3	5	ON	ON	-	-	-	-	0	0	5	-2	0	2	dB
G <sub>4.5M</sub>	4.5MHz gain	TP9	17	4	5	ON	ON	-	-	-	-	0	0	0	2	5	8	dB
AG <sub>6.5M</sub>	Automatic 6.5 MHz gain	TP9	11	1	5	ON	ON	-	-	-	-	5	0	0	-4	-2	0	dB
AG <sub>6.0M</sub>	Automatic 6.0 MHz gain	TP9	15	2	5	ON	ON	-	-	-	-	5	0	0	-6	-4	-2	dB
AG <sub>5.5M</sub>	Automatic 5.5 MHz gain	TP9	13	3	5	ON	ON	-	-	-	-	5	0	0	-4	-2	0	dB
SW <sub>1</sub>	4.5MHz SW OUT1	TP6	-	-	5	ON	ON	-	-	-	-	5	5	5	-	0	0.5	V
SW <sub>2</sub>	4.5MHz SW OUT2	TP4	-	-	5	ON	ON	-	-	-	-	0	0	0	-	0	0.5	V
V <sub>4.5M</sub>	Video 4.5MHz voltage	TP20	-	-	5	ON	ON	3	3	3	3	0	0	0	2.5	3	3.5	V
V <sub>5.5M</sub>	Video 5.5MHz voltage	TP20	-	-	5	ON	ON	3	3	3	3	0	0	5	2.5	3	3.5	V
V <sub>6.0M</sub>	Video 6.0MHz voltage	TP20	-	-	5	ON	ON	3	3	3	3	0	5	0	2.5	3	3.5	V
V <sub>6.5M</sub>	Video 6.5MHz voltage	TP20	-	-	5	ON	ON	3	3	3	3	0	5	5	2.5	3	3.5	V
V <sub>AUTO</sub>	Video automatic voltage	TP20	-	-	5	ON	ON	3	3	3	3	5	0	0	2.5	3	3.5	V
GV <sub>4.5M</sub>	Video 4.5MHz gain	TP20	5	5	5	ON	ON	3	3	3	3	0	0	0	-1	0	1	dB
GV <sub>5.5M</sub>	Video 5.5MHz gain	TP20	1	5	5	ON	ON	3	3	3	3	0	0	5	-1	0	1	dB
GV <sub>6.0M</sub>	Video 6.0MHz gain	TP20	2	5	5	ON	ON	3	3	3	3	0	5	0	-1	0	1	dB
G <sub>6.5M</sub>	Video 6.5MHz gain	TP20	3	5	5	ON	ON	3	3	3	3	0	5	5	-1	0	1	dB
GV <sub>AUTO</sub>	Video automatic gain	TP20	1	5	5	ON	ON	3	3	3	3	5	0	0	-1	0	1	dB

MULTIPLE SIF CONVERTER

ELECTRICAL CHARACTERISTICS (cont.)

Symbol	Parameter	Test point	Input		V <sub>CC</sub>	SW		External power supply							Limits			Unit
			Input point	SG		S18	S19	V1	V2	V3	V5	V10	V12	V14	Min.	Typ.	Max.	
V S1	Control 1 switching voltage	TP12	17	4	5	ON	ON	3	3	3	3	0	V	0	2.5	3.0	3.5	V
V S2	Control 2 switching voltage	TP14	17	4	5	ON	ON	3	3	3	3	0	0	V	1.6	2.0	2.6	V
V S3	Control 3 switching voltage	TP10	17	4	5	ON	ON	3	3	3	3	V	0	0	2.0	2.5	3.0	V
S/N	SIF S/N	Sout	17	6 4	5	ON	ON	-	-	-	-	0	0	0	50	55	-	dB
NS	Noise sensitivity	Sout	17	4	5	ON	ON	-	-	-	-	0	0	0	-	65	70	dB $\mu$
SPR	Spurious output	TP9	17	4	5	ON	ON	-	-	-	-	0	0	0	36	41	-	dB
f	Oscillating frequency	7pin	-	-	5	ON	ON	-	-	-	-	0	0	0	991	993	995	kHz

ELECTRICAL CHARACTERISTIC TEST METHODS

G6.5M, G6.0M, G5.5M, G4.5M, AG6.5M, AG6.0M and AG5.5M

Compare each input signal level and the TP9 6MHz level:

$$G = 20 \log \left( \frac{\text{TP9 6MHz level}}{\text{Input level}} \right)$$

GV6.5M, GV5.5M, GV6.0M, GV6.5M and GV AUTO

Compare input level and output level.

$$GV = 20 \log \left( \frac{\text{Output level}}{\text{Input level}} \right)$$

VS1, VS2 and VS3

Increase voltage gradually, starting from 0V, and read the voltage when the mode is switched from 4.5MHz.

S/N

Input SG6 and SG4 to pin ⑰, and compare the Sout levels.

$$S/N = 20 \log \left( \frac{\text{Sout level (SG6 input)}}{\text{Sout level (SG4 input)}} \right)$$

NS

Input SG4 to pin ⑰. Lower input level gradually, and read the input level when the Sout noise exceeds 2 mVrms.

SPR

Measure TP9, and compare sound signal and spurious output.

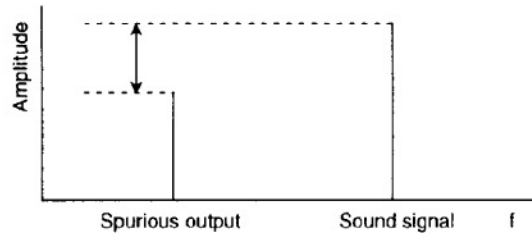

f

Bring probe close to pin ⑰. Read oscillator frequency detected by the probe. Do not contact probe with the pin.

INPUT SIGNALS

SG No.	Input signal (50 $\Omega$ resistance at the terminal)
SG1	f = 6.5MHz V = 100dB $\mu$ CW
SG2	f = 6.0MHz V = 100dB $\mu$ CW
SG3	f = 5.5MHz V = 100dB $\mu$ CW
SG4	f = 4.5MHz V = 100dB $\mu$ CW
SG5	f = 6.0MHz V = 2V <sub>P-P</sub> CW
SG6	f = 4.5MHz 100dB $\mu$ FM400Hz $\pm$ 25kHzdev

# M52317SP

## MULTIPLE SIF CONVERTER

### TEST CIRCUIT

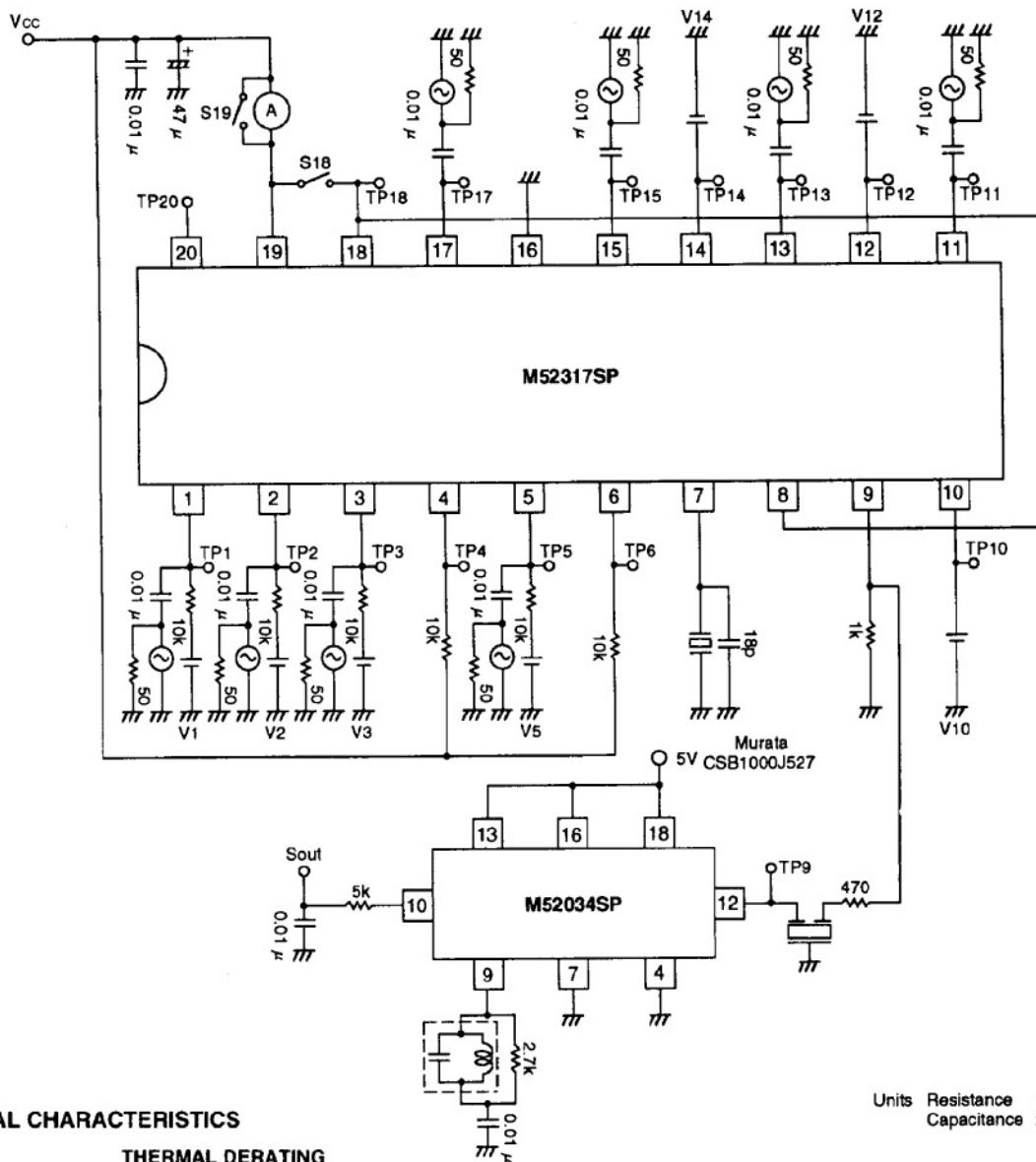

Units Resistance : Ω  
Capacitance : F

### TYPICAL CHARACTERISTICS

#### THERMAL DERATING (MAXIMUM RATING)

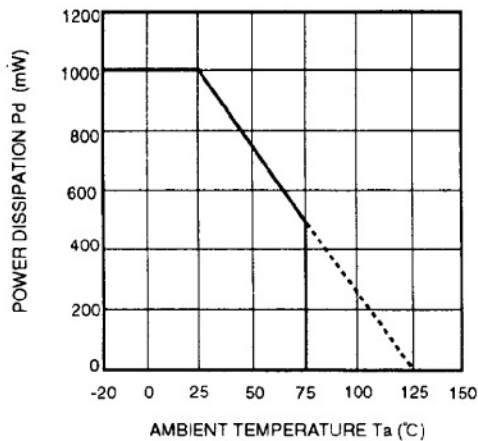

MULTIPLE SIF CONVERTER

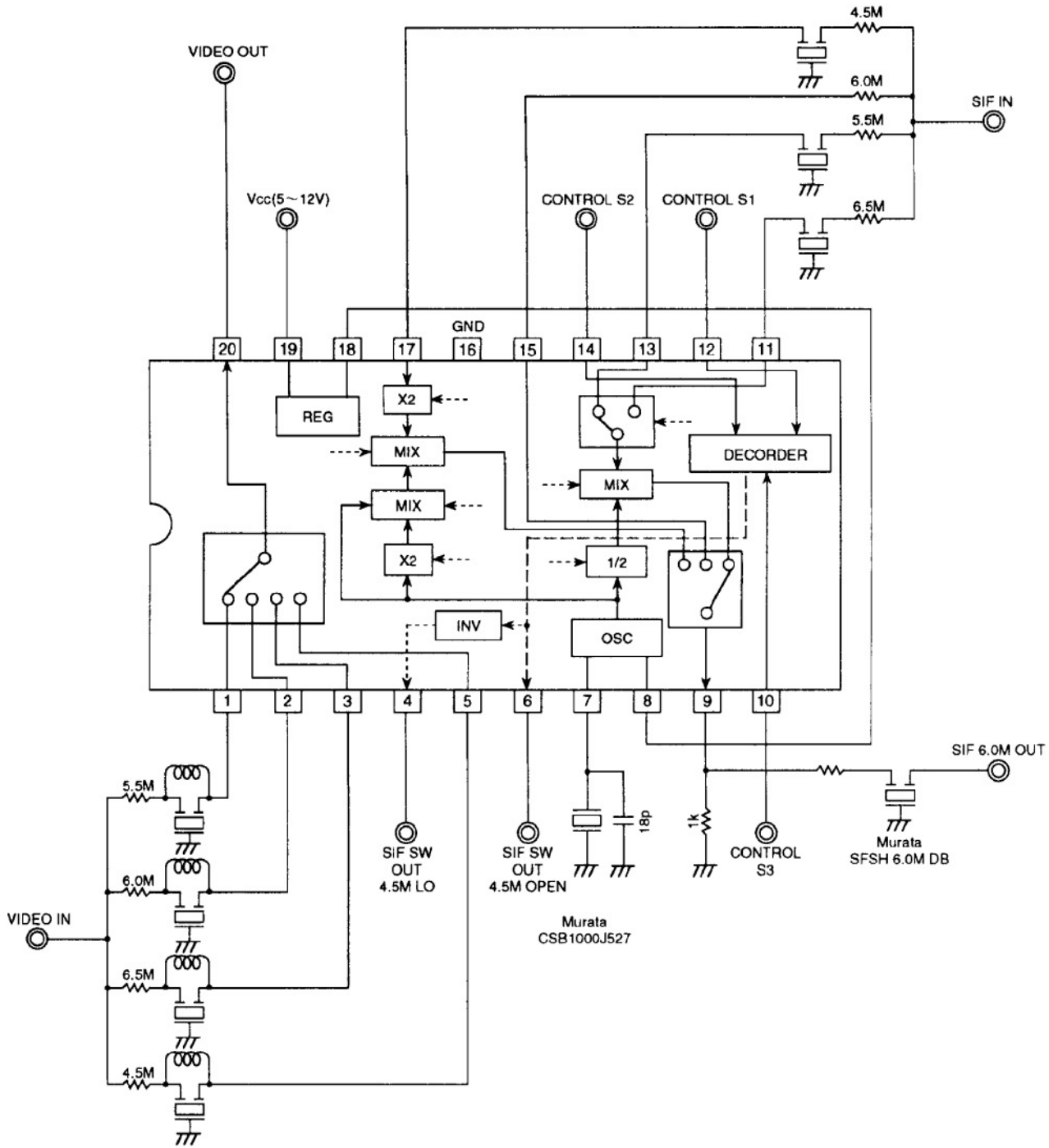

APPLICATION EXAMPLE



Units Resistance :  $\Omega$   
Capacitance : F



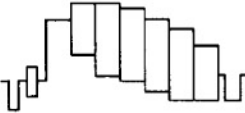
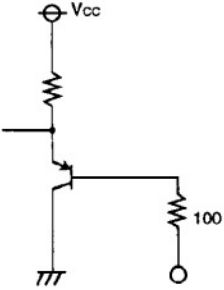
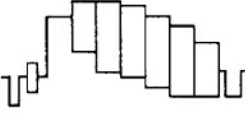
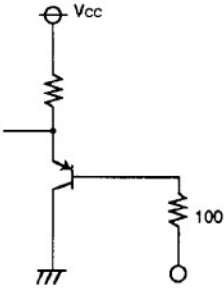
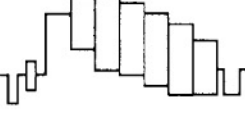
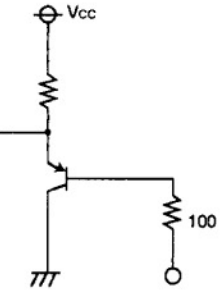

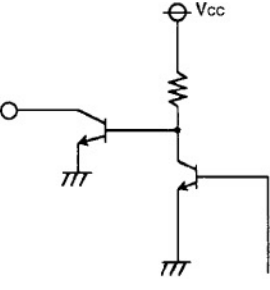
MULTIPLE SIF CONVERTER

DESCRIPTION OF PIN

Pin No.	Name	Voltage and wave information	Peripheral circuit of pins
①	VIDEO 5.5M-IN		
②	VIDEO 6.0M-IN		
③	VIDEO 6.5M-IN		
④	4.5M-SW (LO)		

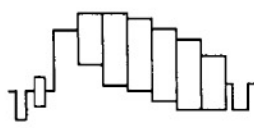
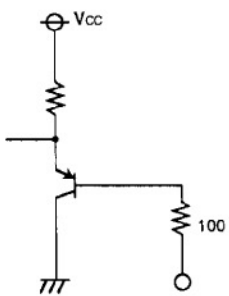
MULTIPLE SIF CONVERTER

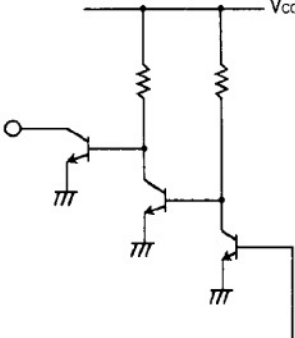
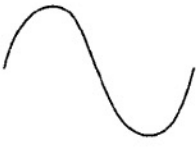
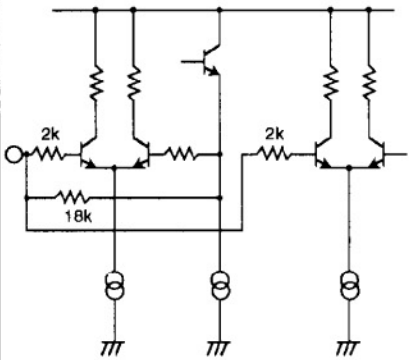

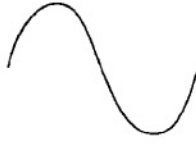
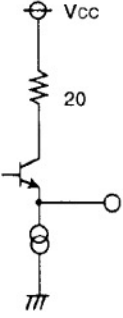

DESCRIPTION OF PIN (cont.)

Pin No.	Name	Voltage and wave information	Peripheral circuit of pins
⑤	VIDEO 4.5M-IN		
⑥	4.5M-SW (OPEN)		
⑦	OSC	about 2.3V 	
⑧	OSC Vcc	5V DC	
⑨	6.0M-OUT		

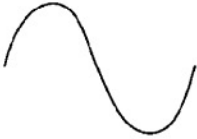

MULTIPLE SIF CONVERTER

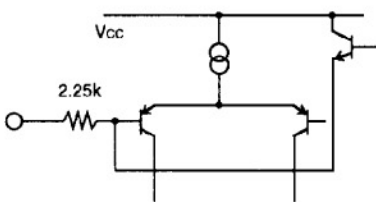
DESCRIPTION OF PIN (cont.)

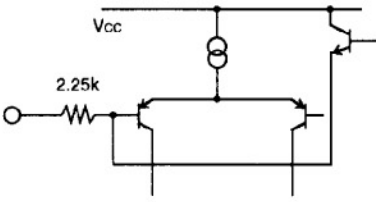
Pin No.	Name	Voltage and wave information	Peripheral circuit of pins
⑩	CONTROL S3	—	
⑪	6.5M-IN	<p>about 2V</p> 	
⑫	CONTROL S1	—	
⑬	5.5M-IN	<p>about 2V</p> 	

MULTIPLE SIF CONVERTER

DESCRIPTION OF PIN (cont.)

Pin No.	Name	Voltage and wave information	Peripheral circuit of pins
⑭	CONTROL S2	—	
⑮	6.0M-IN	about 2V 	
⑯	GND	0V DC	—
⑰	4.5M-IN	about 2V 	
⑱	Vcc2	5V DC	—
⑲	Vcc1	5V DC	—
⑳	VIDEO-OUT	—	

**INSTRUCTIONS****Control logic and switch output**

	4.5MHz	5.5MHz	6.0MHz	6.5MHz	AUTO
S1	L	L	H	H	—
S2	L	H	L	H	—
S3	L	L	L	L	H
Pin 4 output	L	OPEN	OPEN	OPEN	OPEN
Pin 6 output	OPEN	L	L	L	L

**SETUP INSTRUCTIONS**

The M52317SP has two power supply pins:  $V_{CC1}$  (pin ⑨) is used for the video switch circuit and 5V stabilizing power supply circuit.  $V_{CC2}$ (pin⑩) is used for other blocks. When this IC is connected to another IC, such as a video intermediate frequency converter whose  $V_{CC}$  is 5V or more, connect  $V_{CC1}$  to that IC's  $V_{CC}$ , and keep  $V_{CC2}$  open. The  $V_{CC}$  and  $V_{CC1}$  should be the same. The blocks connected to  $V_{CC2}$  are powered by the internal 5V stabilizing supply circuit. When the  $V_{CC}$  of the other IC is 5V, apply 5V to  $V_{CC1}$  and  $V_{CC2}$ .

**SPECIAL PARTS**

Special parts listed below may be used with this IC:

Oscillator CSB1000J527

(Product of Murata Mfg. Co.,Ltd.)

Filters SFSH6.0MDB, SFE6.5MB, SFE4.5MB and SFE5.5MB

(Products of Murata Mfg. Co.,Ltd.)

Traps TPS4.5MB, TPS5.5MB, TPS6.0MB and TPS6.5MB