

Miniature Circuit-Breakers (MCBs)

2



General Data	Product range.....	2/2
	Summary of technical data.....	2/3
	Description	2/4
Power Supply Company Product Range	5SP3 Selective main miniature circuit-breakers (SHU), 25 kA	2/27
	Accessories	2/27
N-Type Standard Product Range	5SQ3 Miniature circuit-breakers 6 kA, AC model	2/29
	5SX2 Miniature circuit-breakers 6 kA, AC model	2/30
	5SX4 Miniature circuit-breakers 10 kA, AC model	2/35
N-Type AC/DC Product Range	5SX5 Miniature circuit-breakers 10 kA, 4.5 kA	2/38
N-Type Standard and AC/DC Product Range	Additional components for 5SX2, 5SX4, 5SX5 miniature circuit-breakers.....	2/39
	Accessories for 5SX2, 5SX4, 5SX5 miniature circuit-breakers.....	2/40
Industry Guard Product Range	5SY4 Miniature circuit-breakers 10 kA, AC model	2/43
	5SY7 Miniature circuit-breakers 15 kA, AC model	2/50
	Accessories for 5SY4, 5SY7 Miniature circuit-breakers.....	2/55
High-Current Product Range	5SP4 Miniature circuit-breakers 10 kA, AC model	2/56
Industry Guard/ High-Current Product Range	Additional components for 5SY4, 5SY7, 5SP4 miniature circuit-breakers.....	2/59
	Accessories for 5SY4/5SY7/5SP4 miniature circuit-breakers.....	2/62
Power Supply Company, Standard, AC/DC, Industry Guard/High-Current Product Range	Accessories	2/63
Screw-In Design	According to DIN 49 500, 6 kA	2/63
Planning Aid	Dimensions.....	2/63

Miniature Circuit-Breakers (MCBs)

General Data

Product overview

Design	Tripping characteristic	Rated currents I_n	Rated breaking capacity	Energy limitation class
Power supply company product range				
5SP3	E	16 - 100 A	25 000	
Standard product range				
5SX2	A	1 - 40 A	6 000	
	B	6 - 50 A	3	
	C	0.3 - 63 A		
	D	0.5 - 50 A		
5SX4	B	6 - 50 A	10 000	
	C	0.5 - 50 A	3	
AC/DC product range				
5SX5	B	6 - 32 A	4 500	10 000 T4
	C	0.5 - 32 A	3	
Industry guard product range				
5SY4	A	1 - 63 A	10 000	
	B	6 - 63 A	3	
	C	0.3 - 63 A		
	D	0.3 - 63 A		
5SY7	B	6 - 63 A	15 000	
	C	0.3 - 63 A	3	
	D	0.3 - 63 A		
High-current product range				
5SP4	B	80 - 125 A	10 000	
	C	80 - 125 A		
	D	80 - 100 A		

Definitions

1 MW = Modular width of
18 mm

N-type = 55 mm device
mounting depth

Depth 70 mm =
Device mounting depth of
70 mm

Miniature Circuit-Breakers (MCBs)

General Data

Summary of technical data

2

			5SX2	5SX4	5SX5	5SY4	5SY7	5SP4
Tripping characteristics			A, B, C, D	B, C	B, C	A, B, C, D	B, C, D	B, C, D
No. of poles	1		•	•	•	•	•	•
	2		•	•	•	•	•	•
	3		•	•	•	•	•	•
	4		•	•	•	•	•	•
	1 + N		•	•	•	•	•	•
	3 + N		•	•	•	•	•	•
Rated voltage	V AC		230/400					
	V DC		-		220/440	-		
Operating voltage	min. AC/DC	V	24					
	max. DC	V/Pol	60 ¹⁾		220	60 ¹⁾		
	max. AC	V	440					
Rated breaking capacity acc. to DIN VDE 0641, EN 60 898	AC	kA	6	10	4.5	10	15	10
	DC	kA	-		10	-		
Insulation coordination	Rated insulation voltage	AC V	250/440					
	Degree of pollution for overvoltage category III		2					
Degree of protection • 5SX., 5SP. • 5SY.			IP 00 according to DIN 40 050, IP 40 when mounted in distribution boards					
			IP 20 according to DIN 40 050, IP 40 when mounted in distribution boards					
Flammability			Category IIb according to DIN VDE 0304 Part 3					
Mounting			To be snapped onto a 35 mm standard mounting rail (DIN EN 50 022); with • 5SY4, 5SY7: rapid mounting system, no tools required • 5SP4: also screw mounting					
Terminals			5SX2, 5SX4, 5SX5 combined terminals below for simultaneous connection to bus-bars (fork-type) and feeder cables 5SY4, 5SY7 combined terminals on both ends for simultaneous connection to bus-bars (pin-type) and feeder cables 5SP4 tunnel terminals on both ends					
Conductor cross sections Solid and stranded, max. • Upper terminal • Lower terminal Finely stranded with end sleeves, max. • Upper terminal • Lower terminal	mm ²	mm ²	16		35		50	
		mm ²	25		35		50	
	mm ²	mm ²	10		25		35	
		mm ²	16		25		35	
Terminal tightening torque	recommended	Nm	2.5 - 3					3 - 4
Supply connection			As required, observe the polarity for DC applications					
Mounting position			As required					
Service life			On the average 20,000 operations at rated load					
Ambient temperature	°C		-25 to +45, occasionally +55, max. 95 % humidity, storage temperature: -40 to +75					
Resistance to climate			According to IEC 60 068-2-30, 6 cycles					
Resistance to vibration	m/s ²		60 at 10 Hz up to 150 Hz according to IEC 60 068-2-6					

Further technical data on request or see next page.

1) ≙ Battery charging voltage 72 V.

Miniature Circuit-Breakers (MCBs)

General Data

Description

Areas of application

MCBs of the *N System* primarily protect cables and conductors against overload and short circuit. Thus, they also protect electrical equipment against overheating according to DIN VDE 0100 Part 430.

Under certain conditions, MCBs also protect against shock currents caused by excessive touch voltage due to insulation failure according to DIN VDE 0100 Part 410.

Further, due to the fixed rated current settings of MCBs, it is also possible to protect motors in a limited form.

For the respective application, there are different tripping characteristics available which will be individually described in the catalog I 2.1 in detail.

The standards EN 60 898, DIN VDE 0641 Part 11 and IEC 60 898 form the basis for the design and approval of the MCBs.

For applications in industry and in system and plant engineering where MCBs of the *N System* are used, additional components are available, such as auxiliary switches, fault signal contacts, shunt trips, undervoltage releases, RCCB modules as well as add-on accessories such as busbar systems and mounting parts.

Functional design, mode of operation

MCBs of the *N System* operate using a delayed overload current/time-dependent thermal release (thermal bimetal) for low overcurrents and an instantaneous electromagnetic release for higher overload and short-circuit currents.

The special contact materials used assure a long service life and offer a high level of protection against contact welding.

MCBs of the *N System* significantly limit the let-through current when a fault occurs due to the ultra-fast contact separation and the quick quenching of the arc in the arc-chamber.

Thus, generally, they fall below the permissible limiting I^2t values of energy limiting class 3, specified in DIN VDE 0641 Part 11 by 50%. This guarantees excellent selectivity with the upstream overcurrent protective devices.

Features

- High rated breaking capacity up to 15,000 A according to EN 60 898
- Excellent current limiting and selectivity
- Tripping characteristics A, B, C and D
- Terminals are safe from finger touch and touch by the back of the hand
- Combined terminal allows busbar and feeder cable to be simultaneously connected
- Uniform additional components, quick mounting using snap-on and snap-in mechanism on site
- Handle locking device effectively prevents unauthorized operation of the handle

Features of 5SX

- Especially suitable for mounting in flat distribution boards for building installations

Features of 5SY. ... :

- Safe and rapid connection of the feeder cable by moving the busbar to the back
- Identical terminals on both ends for optional infeed from the top or the bottom
- Mounting and dismounting without tools
- Rapid and comfortable removal from the assembly
- Variable labeling system
- Separate switch position indication

Features of 5SP4 ... :

- Disconnecter characteristics acc. to DIN VDE 0660 Part 107
- Main switch characteristics acc. to EN 60 204
- Variable labeling system
- Can be screwed on base
- Separate switch position indicator

Application examples for 5SX miniature circuit-breakers.



Feeder cables from below with cross sections up to 25 mm² and 3-pole 5ST2 144 busbars can be simultaneously connected at the combined terminal of the MCB.



Feeder cables from below with cross sections up to 35 mm² and 2-pole 5ST2 143 busbars can be simultaneously connected using the 5ST2 166 terminal.

Cables connected from the top use the same principle.



Feeder cables from above with cross sections up to 35 mm² can be connected to 5ST2 144 busbars using the 5ST2 157 supplementary terminal.



Feeder cables with cross sections up to 25 mm² and 5ST2 165 busbars can be simultaneously connected at the combined terminal of the MCB using the auxiliary contacts mounted on site.

[A description of the busbars and terminals is available on page 2/41.](#)

Miniature Circuit-Breakers (MCBs)

General Data

Description

Features of 5SY miniature circuit-breakers



Easier, faster, more wiring space

- Identical terminals at the top and bottom
- Connection of the feeder cable in front of the busbar
- Larger and easier accessible wiring space for the feeder cable
- Comfortable insertion of the feeder cables into the busbar
- Clear, visible and controllable terminal of the feeder cables
- Universal infeed with busbar mounting at the top or bottom



Shock-hazard protection with clear advantages

- Integrated, movable terminal covers in the area of the feeder cable entries
- With tightened screws, the terminals are completely enclosed
- Effective shock-hazard protection even if fully grabbed
- VBG 4/BGV A2 requirements are exceeded by far

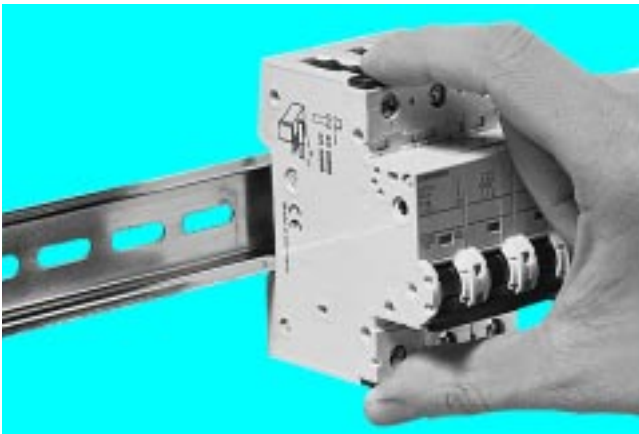

Flexible and without tools

- Manually and without tools operable rapid mounting and dismantling system
- Rapid mounting and dismantling of the 5SY MCB onto and from the standard mounting rails acc. to DIN EN 50 022
- Devices can be replaced easily and comfortably at any time

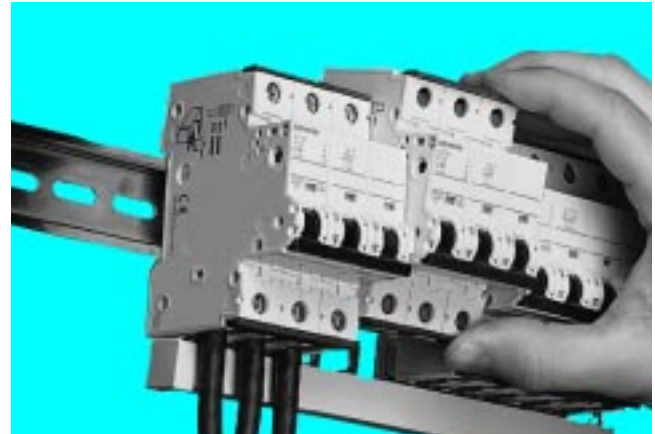

Removal from the assembly

As a result of the combination of the various features, the 5SY MCBs can easily and rapidly be removed from the assembly if circuits have to be changed: It is no longer necessary to remove the busbar.

Tripping characteristics acc. to EN 60 898, DIN VDE 0641 Part 11

Tripping characteristic A

- For limited semiconductor protection
- Protection of measuring circuits with transformers
- Protection of circuits with long cable lengths which will require tripping within 0.4 s acc. to DIN VDE 0100 Part 410

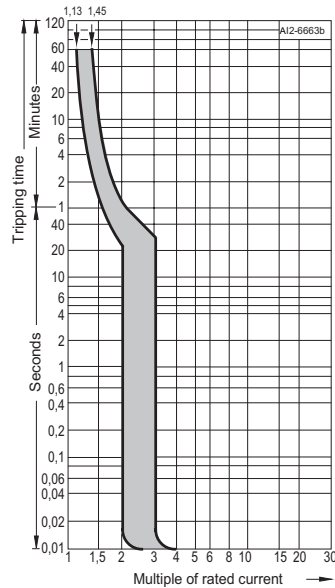

Tripping characteristic B

- Cable and line protection mainly in residential buildings, proof regarding shock-hazard protection is not necessary

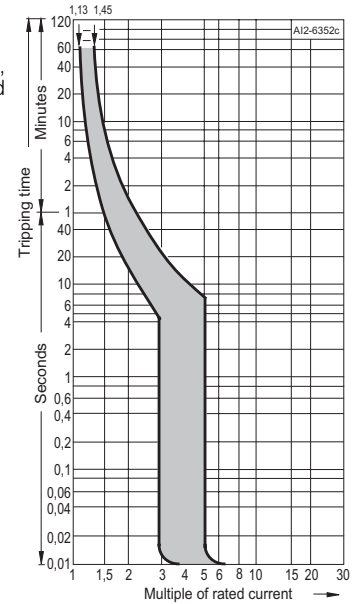

Tripping characteristic C

- Cable and line protection, advantageous in case of higher inrush currents, e.g. lamps, motors etc.

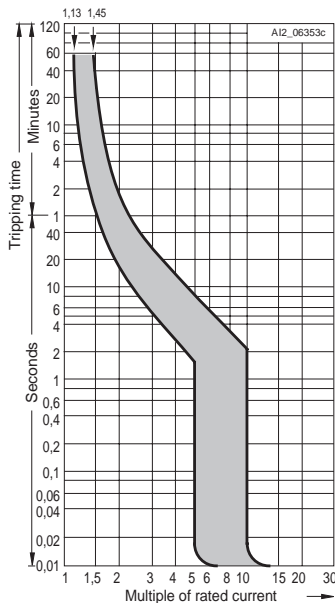

Tripping characteristic D

- The tripping range has been matched to applications involving equipment generating significant pulses (transformers, solenoid valves)

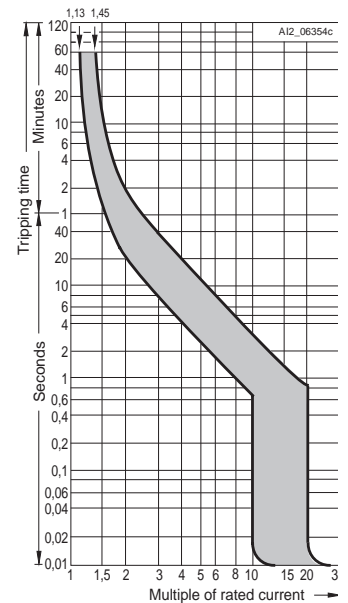

At other ambient temperatures, the currents of the delayed tripping change by approximately 5 % for each 10 K temperature difference. More specifically they increase for temperatures below 30°C and decrease for temperatures above 30°C. For DC, the limit currents of the instantaneous tripping increase by a factor of 1.2.

If more than one circuit in a series of MCBs is loaded, this has an impact on the characteristic as a result of an increased ambient temperature. In this case, an additional correction factor must be applied, referred to the rated miniature circuit-breaker current.

Number	1	2 - 3	4 - 6	> 7
Correction factor K	1.00	0.90	0.88	0.85

Miniature Circuit-Breakers (MCBs)

General Data

Description

Tripping characteristics

Tripping performance at an ambient temperature of 30 °C

Tripping characteristic	Standards	Thermal release				Electromagnetic release		
		Test currents:		tripping time		hold	trips at the latest at	tripping time
		low test current	high test current	63 A ≤ I _n	≤ 125 A	I ₄	I ₅	t
		I ₁	I ₂	t				
A		1.13 × I _n		> 1 h	> 2 h	2 × I _n		≥ 0.1 s
			1.45 × I _n	< 1 h	< 2 h		3 × I _n	< 0.1 s
B	IEC 60 898/EN 60 898 DIN VDE 0641 Part 11	1.13 × I _n		> 1 h	> 2 h	3 × I _n		≥ 0.1 s
			1.45 × I _n	< 1 h	< 2 h		5 × I _n	< 0.1 s
C		1.13 × I _n		> 1 h	> 2 h	5 × I _n		≥ 0.1 s
			1.45 × I _n	< 1 h	< 2 h		10 × I _n	< 0.1 s
D		1.13 × I _n		> 1 h	> 2 h	10 × I _n		≥ 0.1 s
			1.45 × I _n	< 1 h	< 2 h		20 × I _n	< 0.1 s
								(IEC 60 898: 50 × I _n)

Breaking capacity

For MCBs, there are special requirements with regard to the breaking capacity.

The values are standardized and determined according to the testing conditions of EN 60 898 and DIN VDE 0641 Part 11.

The most usual values are 6 000 and 10 000.

For other test conditions, other values can be specified which lie above those of EN 60 898 and DIN VDE 0641 Part 11.

An example of another standard is EN 60 947-2 or DIN VDE 0660 Part 101 for MCBs.

Detailed information on breaking capacity depending on the rated current and other operating voltages is available on request.

Rated breaking capacity

Rated current	I _n [A]	EN 60 898 (IEC 60 898)		EN 60 947-2 (IEC 60 947-2)	
		1-pole 230 V AC I _{cn} [kA]	2-, 3-, 4-pole 400 V AC I _{cn} [kA]	1-pole 230 V AC I _{cu} [kA]	2-, 3-, 4-pole 400 V AC I _{cu} [kA]
5SX2	0.5 - 63	6	6	10 ¹⁾	10 ¹⁾
5SX4	0.5 - 50	10	10	15 ²⁾	15 ²⁾
5SP4	40 - 125	10	10	15	15
5SY4	0.3 - 63	10	10	15	15
5SY7	0.3 - 63	15	15	20	20

Rated current	I _n [A]	E DIN VDE 0641 T 12		E DIN VDE 0641 T 12	
		1-pole 230 V AC I _{cn} [kA]	2-pole 400 V AC I _{cn} [kA]	1-pole 220 V DC I _{cn} [kA]	2-pole 440 V DC I _{cn} [kA]
5SX5	0.5 - 32	4.5	4.5	10 ¹⁾	10 ¹⁾

1) I_n = 63 A corresponds to I_{cu} = 6 kA

2) I_n = 40 A and 50 A corresponds to I_{cu} = 10 kA

Miniature Circuit-Breakers (MCBs) General Data

Description

2

Selectivity of miniature circuit-breakers/fuses

Generally, distribution networks are configured as radial networks. An overcurrent device must be provided at each reduction of the conductor cross section. This results in a cascade graded according to the rated current, which should, where possible, provide selectivity.

Selectivity means, that in the event of a fault, only the protective device in the vicinity of the fault trips. Thus, parallel current paths can continue to provide the necessary power. For MCBs with upstream fuses, the selectivity limit essentially depends on the current limits and tripping characteristics of

the MCB as well as on the pre-arcing I^2t value of the fuse. Therefore, MCBs with different characteristics and rated breaking capacities also have different selectivity limits. The subsequent tables show the currents up to which selectivity is provided between MCBs and upstream fuses according

to DIN VDE 0636 Part 21. The values specified in kA are limit values which have been determined under unfavorable test conditions. In practice, better values can be obtained, depending on the type of the upstream fuse.

Limit values of the MCBs/fuses selectivity in kA

Downstream MCBs	I_n [A]	Upstream fuses							
		16 A	20 A	25 A	35 A	50 A	63 A	80 A	100 A
5SX2									
Characteristic A	≤ 2	0.4	0.7	2.0	•	•	•	•	•
	3	0.3	0.6	1.6	2.0	•	•	•	•
	4	0.3	0.6	0.9	1.6	•	•	•	•
	6	0.2	0.4	0.8	1.2	3.0	3.2	•	•
	10	-	0.4	0.6	1.1	2.2	3.0	•	•
	16	-	-	0.5	1.0	2.0	2.6	4.5	•
	20	-	-	-	1.0	2.0	2.4	4.1	•
	25	-	-	-	-	1.5	2.0	3.7	•
	32	-	-	-	-	1.2	1.8	3.0	5.0
	40	-	-	-	-	-	1.7	2.5	4.0
Characteristic B	6	0.3	0.4	0.7	1.2	3.0	3.2	•	•
	10	-	0.4	0.6	1.0	2.2	3.0	5.0	•
	13	-	-	0.5	1.0	2.2	3.0	5.0	•
	16	-	-	-	1.0	2.0	2.4	4.0	•
	20	-	-	-	-	2.0	2.4	4.0	•
	25	-	-	-	-	-	2.0	3.5	•
	32	-	-	-	-	-	1.7	2.9	•
	40	-	-	-	-	-	-	2.0	4.0
50	-	-	-	-	-	-	-	4.0	
Characteristic C	≤ 2	0.3	0.5	1.2	1.7	•	•	•	•
	3	0.3	0.4	0.8	1.4	4.0	5.0	•	•
	4	0.3	0.4	0.6	1.1	3.0	4.0	•	•
	6	-	0.4	0.6	1.0	2.4	3.2	•	•
	8	-	-	0.5	0.9	1.4	2.6	3.1	•
	10	-	-	0.5	0.9	1.4	2.1	3.1	•
	13	-	-	-	0.8	1.3	2.0	3.0	•
	16	-	-	-	0.8	1.3	2.0	3.0	•
	20	-	-	-	-	1.3	2.0	2.7	•
	25	-	-	-	-	-	2.0	2.4	5.0
	32	-	-	-	-	-	-	2.2	4.0
	40	-	-	-	-	-	-	-	3.5
	50	-	-	-	-	-	-	-	3.0
63	-	-	-	-	-	-	-	3.0	
Characteristic D	≤ 2	0.3	0.4	0.7	1.3	3.0	•	•	•
	3	0.3	0.4	0.7	1.2	3.0	•	•	•
	4	-	0.4	0.6	1.0	2.5	4.0	•	•
	6	-	-	0.5	0.9	2.0	3.0	•	•
	8	-	-	-	0.7	1.4	2.0	3.1	•
	10	-	-	-	-	1.4	2.0	3.1	•
	13	-	-	-	-	-	1.7	3.0	•
	16	-	-	-	-	-	1.7	3.0	•
	20	-	-	-	-	-	-	2.4	5.0
	25	-	-	-	-	-	-	-	5.0
	32	-	-	-	-	-	-	-	4.0
	40	-	-	-	-	-	-	-	-
	50	-	-	-	-	-	-	-	-

• $\hat{=}$ Rated breaking capacity 5SX2 acc. to EN 60 898 6 000

Miniature Circuit-Breakers (MCBs)

General Data

Description

Selectivity of MCBs/fuses

In the event of a short circuit, when using the 5SX4, 5SY4,

5SP4 MCBs and fuses according to DIN VDE 0636 Part 21,

selectivity is provided up to the indicated values in kA.

Limit values of the MCBs/fuses selectivity in kA

Downstream MCBs	I_n [A]	Upstream fuses								
		16 A	20 A	25 A	35 A	50 A	63 A	80 A	100 A	125 A
5SX4, 5SY4										
Characteristics A, B	6	0.3	0.4	0.8	1.4	3.2	4.5	9.0	•	•
	10	-	0.4	0.7	1.2	2.5	3.5	5.0	•	•
	13	-	-	0.7	1.2	2.5	3.5	5.0	•	•
	16	-	-	-	1.0	2.0	2.8	4.2	9.0	•
	20	-	-	-	1.0	2.0	2.6	4.2	9.0	•
	25	-	-	-	-	1.7	2.2	3.7	7.0	•
	32	-	-	-	-	1.7	2.2	3.7	7.0	•
	40	-	-	-	-	-	1.6	2.2	4.0	6.0
	50	-	-	-	-	-	-	2.2	4.0	6.0
	63	-	-	-	-	-	-	-	3.0	5.0
	Characteristic C	≤ 2	0.3	0.5	1.5	2.0	9.0	•	•	•
3		0.3	0.4	1.1	1.6	5.0	6.0	•	•	•
4		0.3	0.4	0.9	1.4	3.5	5.0	9.0	•	•
6		-	0.4	0.8	1.4	2.7	4.5	6.0	•	•
8		-	-	0.6	1.2	2.2	3.5	5.0	7.0	•
10		-	-	0.5	1.2	2.0	3.0	4.2	7.0	•
13		-	-	-	1.0	1.6	2.4	3.4	6.0	•
16		-	-	-	1.0	1.5	2.2	3.0	6.0	•
20		-	-	-	-	1.3	2.2	3.0	6.0	•
25		-	-	-	-	-	2.2	2.9	5.0	9.0
32		-	-	-	-	-	-	2.4	4.0	7.0
40	-	-	-	-	-	-	2.0	3.5	4.0	
50	-	-	-	-	-	-	-	3.0	4.0	
63	-	-	-	-	-	-	-	-	-	
Characteristic D	≤ 2	0.3	0.4	1.0	1.8	5.0	7.0	•	•	•
	3	0.3	0.4	0.9	1.5	4.0	5.0	8.0	•	•
	4	-	0.4	0.8	1.2	3.0	3.8	5.5	•	•
	6	-	-	0.7	1.1	2.5	3.1	4.4	8.1	•
	8	-	-	-	0.9	2.1	2.5	3.5	6.2	9.3
	10	-	-	-	-	2.1	2.5	3.5	6.2	9.3
	13	-	-	-	-	-	2.5	3.5	6.2	9.3
	16	-	-	-	-	-	2.2	3.1	5.1	7.5
	20	-	-	-	-	-	-	2.7	4.3	6.3
	32	-	-	-	-	-	-	-	4.0	5.5
	40	-	-	-	-	-	-	-	3.5	4.8
50	-	-	-	-	-	-	-	-	4.0	
63	-	-	-	-	-	-	-	-	-	

• $\hat{=}$ Rated breaking capacity 5SX4, 5SY4 acc. to EN 60 898 10 000

Limit values of the MCBs/fuses selectivity in kA

Downstream MCBs	I_n [A]	Upstream fuses					
		100 A	125 A	160 A	200 A	224 A	250 A
5SP4							
Characteristic B	80	2.8	3.8	5.7	8.1	•	•
	100	-	3.5	5.2	7.0	•	•
	125	-	-	5.2	7.0	•	•
Characteristic C	80	2.5	3.5	5.1	7.5	9.2	•
	100	-	3.3	4.5	6.5	8.0	•
	125	-	-	4.5	6.5	8.0	•
Characteristic D	80	2.3	3.3	4.6	6.9	8.1	•
	100	-	2.8	4.3	6.2	7.5	9.2

• $\hat{=}$ Rated breaking capacity 5SP4 acc. to EN 60 898 10 000

Miniature Circuit-Breakers (MCBs) General Data

Description

2

Selectivity of MCBs/circuit-breakers

Distribution networks can also be configured without any fuses. In these cases, a circuit-breaker acts like an upstream protective device.

In this case, the selectivity limit depends on the level of the peak current I of the miniature circuit breaker and on the tripping current of the circuit-breaker. The following tables specify

the short-circuit currents in kA up to which selectivity is provided between the MCBs and upstream circuit-breakers according to IEC 60 947-2 and DIN VDE 0660, Part 101

at 230/400 V AC, 50 Hz.

Limit values of the MCBs/circuit-breakers selectivity in kA

Downstream MCBs	I_n [A]	$I > [A]$	I_{cn} [kA]	Upstream circuit-breakers									
				3RV1.1					3RV1.2				
				10	12	8	10	12.5	16	20	22	25	
				120	144	96	120	150	192	240	264	300	
				50	50	100	100	100	50	50	50	50	
				Selectivity limits [kA] ¹⁾									
5SX2/5SY4 ...-5													
Characteristic A	2	6	6	0.2	0.2	-	-	0.2	0.2	0.6	1.2	1.5	
	10	30	6	-	-	-	-	-	-	0.3	0.5	0.5	
	16	48	6	-	-	-	-	-	-	0.3	0.4	0.5	
	32	96	6	-	-	-	-	-	-	-	-	-	
	40	120	6	-	-	-	-	-	-	-	-	-	
5SX2/5SX4/5SY4/5SY7 ...-6													
Characteristic B	6	30	6/10	0.2	0.2	-	-	0.2	0.2	0.3	0.5	0.5	
	10	50	6/10	-	0.2	-	-	0.2	0.2	0.3	0.4	0.5	
	13	65	6/10	-	-	-	-	-	0.2	0.2	0.4	0.4	
	16	80	6/10	-	-	-	-	-	-	0.2	0.4	0.4	
	20	100	6/10	-	-	-	-	-	-	-	-	0.4	
	25	125	6/10	-	-	-	-	-	-	-	-	-	
	32	160	6/10	-	-	-	-	-	-	-	-	-	
	40	200	6/10	-	-	-	-	-	-	-	-	-	
	50	250	6/10	-	-	-	-	-	-	-	-	-	
5SX2/5SX4/5SY4/5SY7 ...-7													
Characteristic C	0.5	5	6/10	0.2	0.2	0.1	0.1	0.2	0.2	0.5	0.6	0.6	
	1	10	6/10	0.2	0.2	0.1	0.1	0.2	0.2	0.5	0.6	0.6	
	1.6	16	6/10	0.2	0.2	0.1	0.1	0.2	0.2	0.5	0.6	0.6	
	2	20	6/10	0.2	0.2	0.1	0.1	0.2	0.2	0.5	0.6	0.6	
	3	30	6/10	-	0.2	-	-	0.2	0.2	0.3	0.4	0.5	
	4	40	6/10	-	0.2	-	-	0.2	0.2	0.3	0.4	0.5	
	6	60	6/10	-	0.2	-	-	0.2	0.2	0.3	0.4	0.5	
	8	80	6/10	-	0.2	-	-	0.2	0.2	0.2	0.4	0.4	
	10	100	6/10	-	0.2	-	-	0.2	0.2	0.2	0.4	0.4	
	13	130	6/10	-	-	-	-	-	0.2	0.2	0.4	0.4	
	16	160	6/10	-	-	-	-	-	-	0.2	0.4	0.4	
	20	200	6/10	-	-	-	-	-	-	-	-	0.4	
	25	250	6/10	-	-	-	-	-	-	-	-	-	
	32	320	6/10	-	-	-	-	-	-	-	-	-	
	40	400	6/10	-	-	-	-	-	-	-	-	-	
	50	500	6/10	-	-	-	-	-	-	-	-	-	
	63	630	6	-	-	-	-	-	-	-	-	-	
5SX2/5SY4/5SY7 ...-8													
Characteristic D	2	40	6	-	-	-	-	0.2	0.2	0.4	0.6	0.6	
	6	120	6	-	-	-	-	-	-	0.3	0.4	0.4	
	10	200	6	-	-	-	-	-	-	0.2	0.4	0.4	
	16	320	6	-	-	-	-	-	-	-	-	-	
	32	640	6	-	-	-	-	-	-	-	-	-	
	40	800	6	-	-	-	-	-	-	-	-	-	
	50	1,000	6	-	-	-	-	-	-	-	-	-	

1) In 240/415 V, 50 Hz networks, the selectivity limits must be reduced by 10 %.
 $I > =$ Tripping current.

Miniature Circuit-Breakers (MCBs)

General Data

Description

Selectivity of MCBs/circuit-breakers

Under short-circuit conditions, selectivity is provided between the MCBs and circuit-breakers acc. to IEC 60 947-2 and DIN VDE 0660 Part 101 up to the specified values in kA.

Limit values of the MCBs/fuses selectivity in kA

Downstream MCBs	I_n [A]	$I > [A]$	I_{cn} [kA]	Upstream circuit-breakers						
				3RV1.3						
				16	20	25	32	40	45	50
				192	240	300	384	480	540	600
				50	50	50	50	50	50	50
				Selectivity limits [kA] ¹⁾						
5SX2/5SY4...-5										
Characteristic A	2	6	6	0.2	0.8	1.2	2.5	3	6	6
	10	30	6	0.2	0.4	0.5	0.6	0.8	1	1.2
	16	48	6	-	0.3	0.4	0.6	0.8	0.8	1
	32	96	6	-	-	-	-	0.6	0.8	0.8
	40	120	6	-	-	-	-	-	-	0.8
5SX2/5SX4/5SY4/5SY7...-6										
Characteristic B	6	30	6/10	0.2	0.3	0.5	0.6	0.8	1	1.2
	10	50	6/10	0.2	0.3	0.4	0.6	0.8	1	1.2
	13	65	6/10	0.2	0.3	0.4	0.6	0.8	1	1
	16	80	6/10	-	0.3	0.4	0.6	0.8	1	1
	20	100	6/10	-	-	0.4	0.6	0.8	1	1
	25	125	6/10	-	-	-	0.5	0.6	0.8	0.8
	32	160	6/10	-	-	-	-	0.6	0.8	0.8
	40	200	6/10	-	-	-	-	-	-	0.8
	50	250	6/10	-	-	-	-	-	-	-
5SX2/5SX4/5SY4/5SY7...-7										
Characteristic C	0.5	5	6/10	0.3	0.5	0.6	1	1	1.5	3
	1	10	6/10	0.3	0.5	0.6	1	1	1.5	3
	1.6	16	6/10	0.3	0.5	0.6	1	1	1.5	3
	2	20	6/10	0.3	0.5	0.6	1	1	1.5	3
	3	30	6/10	0.2	0.3	0.4	0.6	0.8	1	1
	4	40	6/10	0.2	0.3	0.4	0.6	0.8	1	1
	6	60	6/10	0.2	0.3	0.4	0.6	0.8	1	1
	8	80	6/10	0.2	0.2	0.4	0.6	0.6	0.8	1
	10	100	6/10	0.2	0.2	0.4	0.6	0.6	0.8	1
	13	130	6/10	0.2	0.2	0.4	0.6	0.6	0.8	1
	16	160	6/10	-	0.2	0.4	0.6	0.6	0.8	1
	20	200	6/10	-	-	0.4	0.6	0.6	0.8	1
	25	250	6/10	-	-	-	0.5	0.6	0.8	0.8
	32	320	6/10	-	-	-	-	0.6	0.8	0.8
	40	400	6/10	-	-	-	-	-	-	0.8
	50	500	6/10	-	-	-	-	-	-	-
	63	630	6	-	-	-	-	-	-	-
5SX2/5SY4/5SY7...-8										
Characteristic D	2	40	6	0.3	0.5	0.6	0.8	1.2	1.5	1.5
	6	120	6	0.2	0.3	0.4	0.6	0.8	1	1
	10	200	6	-	0.3	0.4	0.5	0.6	0.8	0.8
	16	320	6	-	-	-	0.5	0.6	0.6	0.8
	32	640	6	-	-	-	-	-	0.6	0.6
	40	800	6	-	-	-	-	-	-	-
	50	1,000	6	-	-	-	-	-	-	-

1) In 240/415 V, 50 Hz networks, the selectivity limits must be reduced by 10 %.
 $I >$ = Tripping current.

Miniature Circuit-Breakers (MCBs) General Data

Description

2

Selectivity of MCBs/circuit-breakers

Under short-circuit conditions, selectivity is provided between the MCBs and circuit-breakers acc. to IEC 60 947-2 and

DIN VDE 0660 Part 101 up to the specified values in kA.

Limit values of the MCBs/circuit-breakers selectivity in kA

Downstream MCBs	I_n [A]	$I > [A]$	I_{cn} [kA]	Upstream circuit-breakers									
				3RV1.4									
				16	20	25	32	40	50	63	75	90	100
				192	240	300	384	480	600	756	900	1 080	1 140
				100	100	100	100	100	100	100	100	100	100
				Selectivity limits [kA] ¹⁾									
5SX2/5SY4...-5													
Characteristic A	2	6	6/10	0.5	0.8	1.5	2.5	3	6/7.5	6/10	6/10	6/10	6/10
	10	30	6/10	0.3	0.4	0.5	0.6	0.8	1.2	1.5	2.5	3	4
	16	48	6/10	-	0.3	0.5	0.6	0.6	1	1.5	2	3	3
	32	96	6/10	-	-	-	-	0.6	0.8	1.5	2	2.5	3
	40	120	6/10	-	-	-	-	-	0.8	1.2	1.5	2	2
5SX2/5SX4, 5SY4/5SY7...-6													
Characteristic B	6	30	6/10/15	0.2	0.4	0.5	0.6	0.8	1.2	2	3	6/10/15	6/10/15
	10	50	6/10/15	0.2	0.3	0.5	0.6	0.8	1	1.5	2.5	4	4
	13	65	6/10/15	0.2	0.3	0.5	0.6	0.8	1	1.5	2	3	3
	16	80	6/10/15	-	0.3	0.5	0.6	0.8	1	1.5	2	3	3
	20	100	6/10/15	-	-	0.5	0.6	0.8	1	1.5	2	3	3
	25	125	6/10/15	-	-	-	0.5	0.8	0.8	1.5	2	3	3
	32	160	6/10/15	-	-	-	-	0.6	0.8	1.5	2	3	3
	40	200	6/10/15	-	-	-	-	0.6	0.8	1.2	1.5	2.5	2.5
	50	250	6/10/15	-	-	-	-	-	-	1.2	1.5	2.5	2.5
5SX2/5SX4, 5SY4/5SY7...-7													
Characteristic C	0.5	5	6/10/15	0.4	0.6	0.8	0.8	1	3	6/10/15	6/10/15	6/10/15	6/10/15
	1	10	6/10/15	0.4	0.6	0.8	0.8	1	3	6/10/15	6/10/15	6/10/15	6/10/15
	1.6	16	6/10/15	0.4	0.6	0.8	0.8	1	3	6/10/15	6/10/15	6/10/15	6/10/15
	2	20	6/10/15	0.4	0.6	0.8	0.8	1	3	6/10/15	6/10/15	6/10/15	6/10/15
	3	30	6/10/15	0.2	0.3	0.5	0.6	0.8	1	2	2.5	5	5
	4	40	6/10/15	0.2	0.3	0.5	0.6	0.8	1	2	2.5	5	5
	6	60	6/10/15	0.2	0.3	0.5	0.6	0.8	1	2	2.5	5	5
	8	80	6/10/15	0.2	0.3	0.4	0.6	0.6	1	1.5	2	3	3
	10	100	6/10/15	0.2	0.3	0.4	0.6	0.6	1	1.5	2	3	3
	13	130	6/10/15	0.2	0.3	0.4	0.6	0.6	1	1.5	2	3	3
	16	160	6/10/15	-	0.3	0.4	0.6	0.6	1	1.5	2	3	3
	20	200	6/10/15	-	-	0.4	0.6	0.6	1	1.5	2	3	3
	25	250	6/10/15	-	-	-	0.5	0.6	0.8	1.2	1.5	2.5	2.5
	32	320	6/10/15	-	-	-	-	0.6	0.8	1.2	1.5	2.5	2.5
	40	400	6/10/15	-	-	-	-	-	0.6	1	1.5	2	2
	50	500	6/10/15	-	-	-	-	-	-	1	1.2	1.5	2
	63	630	6/10/15	-	-	-	-	-	-	-	-	1.5	1.5
5SX2/5SY4/5SY7...-8													
Characteristic D	2	40	6/10/15	0.4	0.5	0.6	0.8	1	1.5	3	4	6/10/15	6/10/15
	6	120	6/10/15	0.2	0.3	0.4	0.6	0.6	1	1.5	2.5	3	3
	10	200	6/10/15	-	0.3	0.4	0.5	0.6	0.8	1.5	2	3	3
	16	320	6/10/15	-	-	-	0.5	0.6	0.8	1.2	1.5	2.5	2.5
	32	640	6/10/15	-	-	-	-	-	0.6	1	1.5	2	2
	40	800	6/10/15	-	-	-	-	-	-	1	1.2	1.5	1.5
	50	1,000	6/10/15	-	-	-	-	-	-	1	1.2	1.5	1.5
5SP4...-7													
Characteristic C	80	1,600	6/10	-	-	-	-	-	-	-	-	-	1.2
	100	2,000	6/10	-	-	-	-	-	-	-	-	-	-
5SP4...-8													
Characteristic D	80	1,600	6/10	-	-	-	-	-	-	-	-	-	-
	100	2,000	6/10	-	-	-	-	-	-	-	-	-	-

1) In 240/415 V, 50 Hz networks, the selectivity limits must be reduced by 10%.
 $I > =$ Tripping current.

Miniature Circuit-Breakers (MCBs) General Data

Description

2

Selectivity of MCBs/circuit-breakers

Under short-circuit conditions, selectivity is provided between the MCBs and circuit-breakers according to IEC 60 947-2 and DIN VDE 0660 Part 101 up to the specified values in kA.

Limit values of the MCBs/circuit-breakers selectivity in kA

Downstream MCBs	I_n [A]	$I > [A]$	I_{cn} [kA]	Upstream circuit-breakers													
				3VF4				3VF5				3VF6		3VF7	3VF8	3WN1	3WN6
				125	160	200	250	200	250	315	400	315	400-800	400-1250	800-2500	315-6300	315-3200
				1250	1600	2000	2500	2000	2500	3150	4000	3200	1575-6400	15000	20000	3780-75600	3780-48000
				40/70/100	40/70/100	40/70/100	40/70/100	45/70/100	45/70/100	45/70/100	45/70/100	45/70/100	45/70/100	50/70/100	70/100	65/80/100	65/75
				Selectivity limits [kA] ¹⁾													
5SX2/5SX4																	
Characteristic A	2	6	6	6	6	6	6	6	6	6	6	6	6	6	6	6	6
	10	30	6	6	6	6	6	6	6	6	6	6	6	6	6	6	6
	16	48	6	6	6	6	6	6	6	6	6	6	6	6	6	6	6
	32	96	6	6	6	6	6	6	6	6	6	6	6	6	6	6	6
	40	120	6	3.9	4.6	6	6	6	6	6	6	6	6	6	6	6	6
Characteristic B	6	30	6/10	6/10	6/10	6/10	6/10	6/10	6/10	6/10	6/10	6/10	6/10	6/10	6/10	6/10	6/10
	10	50	6/10	6/10	6/10	6/10	6/10	6/10	6/10	6/10	6/10	6/10	6/10	6/10	6/10	6/10	6/10
	13	65	6/10	6/10	6/10	6/10	6/10	6/10	6/10	6/10	6/10	6/10	6/10	6/10	6/10	6/10	6/10
	16	80	6/10	6/10	6/10	6/10	6/10	6/10	6/10	6/10	6/10	6/10	6/10	6/10	6/10	6/10	6/10
	20	100	6/10	6/10	6/10	6/10	6/10	6/10	6/10	6/10	6/10	6/10	6/10	6/10	6/10	6/10	6/10
	25	125	6/10	6/9.6	6/10	6/10	6/10	6/10	6/10	6/10	6/10	6/10	6/10	6/10	6/10	6/10	6/10
	32	160	6/10	6/9.6	6/10	6/10	6/10	6/10	6/10	6/10	6/10	6/10	6/10	6/10	6/10	6/10	6/10
	40	200	6/10	6	6	6	6	6	6	6/10	6/10	6/10	6/10	6/10	6/10	6/10	6/10
	50	250	6/10	5.1	5.9	6	6	6	6	6/10	6/10	6/10	6/10	6/10	6/10	6/10	6/10
	Characteristic C	0.5	5	6/10	6/10	6/10	6/10	6/10	6/10	6/10	6/10	6/10	6/10	6/10	6/10	6/10	6/10
1		10	6/10	6/10	6/10	6/10	6/10	6/10	6/10	6/10	6/10	6/10	6/10	6/10	6/10	6/10	6/10
1.5		15	6/10	6/10	6/10	6/10	6/10	6/10	6/10	6/10	6/10	6/10	6/10	6/10	6/10	6/10	6/10
2		20	6/10	6/10	6/10	6/10	6/10	6/10	6/10	6/10	6/10	6/10	6/10	6/10	6/10	6/10	6/10
3		30	6/10	6/10	6/10	6/10	6/10	6/10	6/10	6/10	6/10	6/10	6/10	6/10	6/10	6/10	6/10
4		40	6/10	6/10	6/10	6/10	6/10	6/10	6/10	6/10	6/10	6/10	6/10	6/10	6/10	6/10	6/10
6		60	6/10	6/10	6/10	6/10	6/10	6/10	6/10	6/10	6/10	6/10	6/10	6/10	6/10	6/10	6/10
8		80	6/10	6/10	6/10	6/10	6/10	6/10	6/10	6/10	6/10	6/10	6/10	6/10	6/10	6/10	6/10
10		100	6/10	6/10	6/10	6/10	6/10	6/10	6/10	6/10	6/10	6/10	6/10	6/10	6/10	6/10	6/10
13		130	6/10	6/10	6/10	6/10	6/10	6/10	6/10	6/10	6/10	6/10	6/10	6/10	6/10	6/10	6/10
16		160	6/10	6/10	6/10	6/10	6/10	6/10	6/10	6/10	6/10	6/10	6/10	6/10	6/10	6/10	6/10
20		200	6/10	6/10	6/10	6/10	6/10	6/10	6/10	6/10	6/10	6/10	6/10	6/10	6/10	6/10	6/10
25		250	6/10	6/8	6/9.1	6/10	6/10	6/10	6/10	6/10	6/10	6/10	6/10	6/10	6/10	6/10	6/10
32		320	6/10	6/8	6/9.1	6/10	6/10	6/10	6/10	6/10	6/10	6/10	6/10	6/10	6/10	6/10	6/10
40		400	6/10	3.6	4.8	6/6.5	6/6.5	6/6.5	6/6.5	6/6.5	6/10	6/10	6/10	6/10	6/10	6/10	6/10
50	500	6/10	3.6	4.8	6/6.2	6/6.2	6/6.2	6/6.3	6/10	6/10	6/10	6/10	6/10	6/10	6/10	6/10	
Characteristic D	2	40	6	6	6	6	6	6	6	6	6	6	6	6	6	6	6
	6	120	6	6	6	6	6	6	6	6	6	6	6	6	6	6	6
	10	200	6	6	6	6	6	6	6	6	6	6	6	6	6	6	6
	16	320	6	6	6	6	6	6	6	6	6	6	6	6	6	6	6
	32	640	6	6	6	6	6	6	6	6	6	6	6	6	6	6	6
	40	800	6	4	4.9	6	6	6	6	6	6	6	6	6	6	6	6
	50	1,000	6	4	4.8	6	6	6	6	6	6	6	6	6	6	6	6
5SP4																	
Characteristic C	80	800	10	1.5	2	3	3	3	3	3	6	8	10	10	10	10	10
	100	1,000	10	1.5	2	3	3	3	3	3	5	6	10	10	10	10	10
Characteristic D	80	1,600	10	-	-	3	3	2.5	3	3	5	6	10	10	10	10	10
	100	2,000	10	-	-	-	2.5	-	3	3	5	6	10	10	10	10	10

Further values for 5SP4 and 5SY on request.

1) In 240/415 V, 50 Hz, the selectivity limits must be reduced by 10 %.
The selectivity limits are valid for adjustable releases for the maximum value, I_n = rated current.
 $I >$ = Tripping current.

Miniature Circuit-Breakers (MCBs)

General Data

Description

Selectivity of MCBs/circuit-breakers

In distribution networks without any fuses, MCBs provide selectivity between themselves within close limits.

This depends on the peak current I of the downstream MCB and on the tripping current of the upstream MCB.

The following table specifies the short-circuit currents in kA up to which selectivity is provided between MCBs connected in series at 230 V AC.

Limit values of the MCBs/circuit-breakers selectivity in kA													
Downstream MCBs				Upstream circuit-breakers									
				5SX4 7 Characteristic C					5SP4 7 Characteristic C		5SP4 8 Characteristic D		
I_n [A]	$I > [A]$	I_{cn} [kA]		20	25	32	40	50	80	100	80	100	
				10	10	10	10	10	10	1,000	1,200	1,500	
				Selectivity limits [kA] ¹⁾									
5SX2/5SX4													
Characteristic B	6	30	6/10	0.2	0.2	0.3	0.5	0.5	0.8	1.5	3	5	
	10	50	6/10	0.2	0.2	0.3	0.5	0.5	0.8	1.2	3	4	
	13	65	6/10	0.2	0.2	0.3	0.4	0.5	0.8	1.2	2	3	
	16	80	6/10	0.2	0.2	0.3	0.4	0.5	0.8	1.2	2	3	
	20	100	6/10	-	0.2	0.3	0.4	0.5	0.8	1.2	2	3	
	25	125	6/10	-	-	-	0.4	0.4	0.6	1.2	1.5	3	
	32	160	6/10	-	-	-	0.4	0.4	0.6	1.2	1.5	3	
	40	200	6/10	-	-	-	-	0.4	0.6	1.2	1.5	2.5	
	50	250	6/10	-	-	-	-	-	0.6	1	1.5	2.5	
Characteristic C	0.5	5	6/10	0.2	0.3	0.5	0.8	0.8	1.2	4	6/10	6/10	
	1	10	6/10	0.2	0.3	0.5	0.8	0.8	1.2	4	6/10	6/10	
	1.5	15	6/10	0.2	0.3	0.5	0.8	0.8	1.2	4	6/10	6/10	
	2	20	6/10	0.2	0.3	0.5	0.8	0.8	1.2	4	6/10	6/10	
	3	30	6/10	0.2	0.2	0.3	0.5	0.5	0.8	1.5	3	4	
	4	40	6/10	0.2	0.2	0.3	0.5	0.5	0.8	1.5	3	4	
	6	60	6/10	0.2	0.2	0.3	0.5	0.5	0.8	1.5	3	4	
	8	80	6/10	0.2	0.2	0.3	0.4	0.4	0.6	1.2	2.5	3	
	10	100	6/10	0.2	0.2	0.3	0.4	0.4	0.6	1.2	2.5	3	
	13	130	6/10	0.2	0.2	0.3	0.4	0.4	0.6	1.2	2	3	
	16	160	6/10	0.2	0.2	0.3	0.4	0.4	0.6	1.2	2	3	
	20	200	6/10	-	0.2	0.3	0.4	0.4	0.6	1.2	2	3	
	25	250	6/10	-	-	-	0.3	0.4	0.6	1	1.5	2.5	
	32	320	6/10	-	-	-	0.3	0.4	0.6	1	1.5	2.5	
	40	400	6/10	-	-	-	-	-	-	0.8	1.5	2	
	50	500	6/10	-	-	-	-	-	-	0.8	1.5	2	
	63	630	6	-	-	-	-	-	-	0.8	1.2	1.5	

Values for 5SY on request.

Miniature Circuit-Breakers (MCBs) General Data

Description

2

Back-up protection, MCBs/fuses



If the level of the maximum short-circuit current flowing at the MCB location is unknown, or if the specified rated breaking

capacity is exceeded, an additional protective device must be connected upstream as back-up protection. This prevents

excessive stressing of the MCB. Generally, a fuse is used for this purpose.

The following table specifies the short-circuit currents in kA up to which back-up protection is ensured if fuses are used acc. to DIN VDE 0636 Part 21.

Limit values of the MCBs/fuses back-up protection in kA

Downstream MCBs	I_n [A]	Upstream fuses					
		50 A	63 A	80 A	100 A	125 A	160 A
5SX2/5SX4		no back-up protection required up to 50 kA					
	0.3-4	no back-up protection required up to 50 kA					
	6	50	50	50	50	50	35
	8	50	50	50	50	50	35
	10	50	50	50	50	50	35
	13	50	50	50	35	35	30
	16	50	50	50	35	30	30
	20	50	50	50	35	25	25
	25	50	50	50	35	30	25
	32	50	50	50	35	30	25
	40	50	50	50	50	25	15
	50	50	50	50	50	25	15
	63	50	50	35	25	25	15
	5SY4/5SY7		no back-up protection required				
	0.3-6	no back-up protection required					
	8	50	50	50	50	45	45
	10	50	50	50	50	45	45
	13	50	50	50	45	40	35
	16	50	50	50	45	40	35
	20	50	50	50	40	35	30
	25	50	50	50	40	35	30
	32	50	50	50	45	40	30
	40	50	50	50	45	40	30
	50	50	50	50	40	35	25
	63	50	50	45	40	35	25

Test circuit data:

$U_D = 250$ V
 $\cos \varphi = 0.3$ to 0.5

Test cycle:

Acc. to EN 60 947 - 2 (0 - C0)

Miniature Circuit-Breakers (MCBs)

General Data

Description

Back-up protection MCBs/circuit-breakers

If MCBs are used in fuseless distribution boards, circuit-breakers are to be provided as

back-up protection according to EN 60 947-2 and DIN VDE 0660 Part 101.

The following table shows the short-circuit currents in kA up to which back-up protection is

guaranteed if circuit-breakers are used.

Limit values of the MCBs/circuit-breakers back-up protection in kA



Downstream MCBs			Upstream circuit-breakers											
I_n [A]	$I > [A]$	I_{cn} [kA]	3VF3 adjustable						3VF3 fixed setting					
			50	63	80	100	125	1 60	50	63	80	100	125	160
5SX2/5SX4			back-up-protection up to kA											
Characteristic A, I_n 0.3-4	6/10		no back-up protection required up to 50 kA											
Characteristic B, I_n 6	6/10		50	50	50	50	50	50	50	50	50	50	50	50
Characteristic C, I_n 8-20	6/10		25	25	25	25	25	25	25	25	25	25	25	25
Characteristic D, I_n 25	6/10		20	20	20	20	20	20	20	20	20	20	20	20
I_n 32	6/10		20	20	20	20	20	20	20	20	20	20	20	20
I_n 40	6/10		20	20	20	20	20	20	20	20	20	20	20	20
I_n 50	6/10		10	10	10	10	10	10	10	10	10	10	10	10
I_n 63	6		10	10	10	10	10	10	10	10	10	10	10	10
5SY4/5SY7			back-up-protection up to kA											
Characteristic A, I_n 0.3-6	10/15		no back-up protection required up to 50 kA											
Characteristic B, I_n 8-10	10/15		35	35	35	35	35	35	35	35	35	35	35	35
Characteristic C, I_n 13-16	10/15		35	35	35	35	35	35	35	35	35	35	35	35
Characteristic D, I_n 20-25	10/15		25	25	25	25	25	25	25	25	25	25	25	25
I_n 32-40	10/15		25	25	25	25	25	25	25	25	25	25	25	25
I_n 50-63	10/15		20	20	20	20	20	20	20	20	20	20	20	20
Downstream MCBs			Upstream circuit-breakers											
I_n [A]	$I > [A]$	I_{cn} [kA]	3VF4				3VF5			3VF6	3VF7	3VF8	3WN1/3WS1	
			125	160	200	250	200	250	315	400	315-630	400-1,250	1,600-2,000	315-6,300
			1,250	1,600	2,000	2,500	2,000	2,500	3,150	4,000	3,200-6,300	15,000	20,000	3,780-75,600
			40/70/100	40/70/100	40/70/100	40/70/100	45/70/100	45/70/100	45/70/100	45/70/100	45/70/100	50/70/100	70/100	65-100
5SX2/5SX4			back-up-protection up to kA											
Characteristic A, I_n 0.3-4	6/10		no back-up protection required up to 50 kA											
Characteristic B, I_n 6	6/10		50	50	50	50	50	50	50	50	50	50	50	
Characteristic C, I_n 8-20	6/10		25	25	25	25	25	25	25	25	25	25	25	
Characteristic D, I_n 25	6/10		20	20	20	20	20	20	20	20	20	20	20	
I_n 32	6/10		20	20	20	20	20	20	20	20	20	20	20	
I_n 40	6/10		20	20	20	20	20	20	20	20	20	20	20	
I_n 50	6/10		10	10	10	10	10	10	10	10	10	10	10	
I_n 63	6		10	10	10	10	10	10	10	10	10	10	10	
5SY4/5SY7			back-up-protection up to kA											
Characteristic A, I_n 0.3-6	10/15		no back-up protection required up to 50 kA											
Characteristic B, I_n 8-10	10/15		35	35	35	35	35	35	35	35	35	35	35	
Characteristic C, I_n 13-16	10/15		35	35	35	35	35	35	35	35	35	35	35	
Characteristic D, I_n 20-25	10/15		25	25	25	25	25	25	25	25	25	25	25	
I_n 32-40	10/15		25	25	25	25	25	25	25	25	25	25	25	
I_n 50-63	10/15		20	20	20	20	20	20	20	20	20	20	20	

Miniature Circuit-Breakers (MCBs) General Data

Description

2

Internal resistances and power losses		Data is per pole (with load I_n)							
I_n [A]	Type A		Type B		Type C		Type D		
	R_1 mΩ	P_V W	R_1 mΩ	P_V W	R_1 mΩ	P_V W	R_1 mΩ	P_V W	
5SX2, 5SX4, 5SX5									
0.5	-	-	-	-	10,500	0.95	-	-	
1	1,400	1.4	-	-	3,000	0.75	3,000	0.75	
1.6	-	-	-	-	640	0.64	650	0.65	
2	540	1.4	-	-	312	0.80	270	0.7	
3	380	1.5	-	-	212	0.85	165	0.66	
4	170	1.5	-	-	82	0.74	77	0.7	
6	120	1.9	-	-	53	0.85	60	1	
8	43	1.5	39	1.4	30	1.10	20	0.7	
10	-	-	-	-	15	0.96	14	0.9	
13	18	1.8	16.5	1.65	12.5	1.25	12	1.2	
16	-	-	11.5	1.94	9	1.52	10	1.7	
20	10	2.5	8.5	1.17	7.8	2	7	1.8	
25	7.5	3	6.5	2.6	6	2.4	5.6	2.2	
32	4.7	2.9	4.8	3	4.5	2.8	4.5	2.8	
40	3.1	3.6	4	4.1	3.7	3.8	2.9	3	
50	2.6	4.2	2.7	4.3	2.5	4	2.4	3.8	
63	-	-	2	5	1.9	4.7	1.8	4.5	
63	-	-	-	-	1.6	6.6	-	-	
5SY4, 5SY7									
0.3	-	-	-	-	11,000	1.0	-	-	
0.5	-	-	-	-	3,340	0.8	3,220	0.8	
1	1983	2.0	-	-	1,760	1.8	1,560	1.6	
1.6	854	2.2	-	-	710	1.8	670	1.7	
2	554	2.2	-	-	470	1.9	465	1.9	
3	218	2.0	-	-	210	1.9	205	1.8	
4	127	2.0	-	-	110	1.8	100	1.6	
6	65	2.3	70	2.5	50	1.8	50	1.8	
8	29.6	1.9	-	-	14	0.9	12	0.8	
10	20.2	2.0	13	1.3	11	1.1	8.8	0.9	
13	11.7	2.0	9.7	1.6	8.5	1.4	8.5	1.4	
16	10.1	2.6	7.2	1.8	6.3	1.6	6.3	1.6	
20	6.2	2.5	4.7	1.9	3.7	1.5	3.7	1.5	
25	5.1	3.2	3.7	2.3	3.6	2.2	3.6	2.2	
32	3.1	3.2	3.0	3.0	3.0	3.0	3.0	3.0	
40	2.5	4.0	2.3	3.7	2.3	3.7	2.3	3.7	
50	1.9	4.8	1.9	4.8	1.9	4.8	1.9	4.8	
63	1.3	5.2	1.3	5.2	1.3	5.2	1.3	5.2	
5SP4									
80	-	-	-	-	0.9	5.8	0.9	5.8	
100	-	-	-	-	0.88	8	0.8	8	
125	-	-	-	-	0.7	10.9	-	-	

Correction factors for power losses

- DC and AC up to 60 Hz x 1.0
- AC
 - 200 Hz x 1.1
 - 400 Hz x 1.15
 - 1,100 Hz x 1.3

Miniature Circuit-Breakers (MCBs)

General Data

Description

Personnel protection using MCBs

According to DIN VDE 0100 Part 410, to provide protection against hazardous shock currents in TN supply networks, the dimensioning of the cross sections of conductors and/or their lengths after the protective

device must ensure that a fault with negligible impedance (i.e. a short circuit) at an arbitrary position between an external and a protective conductor or a connected exposed conductive part causes an automatic

disconnection within the specified times of 0.4 s or 5 s.

This requirement is met by the following condition:

$$Z_s \times I_a \leq U_o$$

Z_s $\hat{=}$ Impedance of the entire fault loop circuit

I_a $\hat{=}$ Current, which causes the disconnection within the specified times

U_o $\hat{=}$ Voltage to ground

Maximum permissible impedance of the fault loop at $U_o = 230 \text{ V AC}$ to comply with the disconnection condition according to DIN VDE 0100 Part 410.

	I_n [A]	Characteristic A		Characteristic B		Characteristic C		Characteristic D	
		$t_a \leq 0.4 \text{ s}$	$\leq 5 \text{ s}$	$t_a \leq 0.4 \text{ s}$	$\leq 5 \text{ s}$	$t_a \leq 5 \text{ s}$	$\leq 5 \text{ s}$	$t_a \leq 0.4 \text{ s}$	$\leq 5 \text{ s}$
		Ω	Ω	Ω	Ω	Ω	Ω	Ω	Ω
5SX, 5SY, 5SP4									
	0.3	-	-	-	-	76.6	153	-	-
	0.5	-	-	-	-	46	92	-	92
	1.0	76.6	76.6	-	-	23	46	15.3	46
	1.6	47.9	47.9	-	-	14.4	28.8	9.6	28.8
	2	38.3	38.3	-	-	11.5	23	7.6	23
	3	25.5	25.5	-	-	7.7	15.4	5.1	15.4
	4	19.1	19.1	-	-	5.8	11.6	3.8	11.6
	6	12.7	12.7	7.6	7.6	3.8	7.6	2.5	7.6
	8	-	-	-	-	2.8	5.7	1.9	5.7
	10	7.6	7.6	4.6	4.6	2.3	4.6	1.1	4.6
	13	-	-	-	3.57	1.7	3.4	0.9	3.4
	16	4.7	4.7	2.9	2.9	1.4	2.8	0.7	2.8
	20	3.8	3.8	2.3	2.3	1.1	2.2	0.5	2.2
	25	3.0	3.0	1.8	1.8	0.9	1.8	0.4	1.8
	32	2.4	2.4	1.4	1.4	0.7	1.4	0.3	1.4
	40	1.9	1.9	1.1	1.1	0.6	1.2	0.28	1.2
	50	-	-	0.9	0.9	0.5	1.0	0.23	1.0
	63	-	-	0.7	0.7	0.4	0.8	0.2	0.8
	80	-	-	-	-	0.3	0.6	0.14	0.6
	100	-	-	-	-	0.2	0.4	0.1	0.4
	125	-	-	-	-	0.16	0.3	0.1	0.3

For $U_o = 240 \text{ V AC}$, $Z_s \times 1.04$.

For $U_o = \text{AC } 127 \text{ V}$, $Z_s \times 0.55$.

Miniature Circuit-Breakers (MCBs) General Data

Description

2

Protecting luminaire circuits

Maximum permissible lamp load for miniature circuit-breaker when feeding fluorescent lamps L 18 W, L 36 W, L 38 W, L 58 W.

Max. number of fluorescent lamps

I _n [A]	Lamp	Conventional controlgear		Electronic controlgear							
		single lamp uncomp.	parallel comp.	full circuit single lamp			two lamps	group circuit single lamp two lamps			
5SX2, 5SX4, 5SX5											
Characteristic		all	all	B	C	D	B	C	D	all	all
10	L 18 W	27	33	25	51	100	34	70	116	100	116
	L 36 W	23	33	25	51	58	34	60	60	58	60
	L 38 W	23	33	25	51	55	34	58	58	55	58
	L 58 W	14	21	17	35	38	16	32	38	38	38
13	L 18 W	35	43	33	66	130	44	90	152	130	152
	L 36 W	30	43	33	66	76	44	78	78	76	78
	L 38 W	30	43	33	66	72	44	76	76	72	76
	L 58 W	19	27	22	45	50	20	42	50	50	50
16	L 18 W	43	53	41	82	160	56	112	188	160	188
	L 36 W	37	53	41	82	94	56	96	96	94	96
	L 38 W	37	53	41	82	88	56	94	94	88	94
	L 58 W	23	34	28	56	61	26	52	62	61	62
20	L 18 W	54	66	51	102	200	70	140	234	200	234
	L 36 W	46	66	51	102	117	70	120	120	117	120
	L 38 W	46	66	51	102	111	70	116	116	111	116
	L 58 W	29	42	35	70	76	32	66	78	76	78
25	L 18 W	67	83	64	128	250	86	174	294	250	294
	L 36 W	58	83	64	128	147	86	150	150	147	150
	L 38 W	58	83	64	128	138	86	146	146	138	146
	L 58 W	37	53	43	87	96	40	82	98	96	98
32	L 18 W	86	106	82	164	320	112	224	376	320	376
	L 36 W	74	106	82	164	188	112	192	192	188	192
	L 38 W	74	106	82	164	177	112	188	188	177	188
	L 58 W	47	68	56	112	123	52	106	124	123	124

Comment:

MCB version:

The specified lamp load values are valid for single-pole MCBs. When using multi-pole MCBs, the permissible number of lamps is reduced by 20 %.

Circuit impedance:

The specified lamp load values are valid, taking into account a cable impedance of 800 mΩ.

For 400 mΩ the permissible values are reduced by 10 %, for 200 mΩ by 20 %.

DC operation:

The values in the table are also valid for DC operation for 5SX5 MCBs in conjunction with electronic controlgear.

Maximum number of 12 V low-voltage halogen lamps

I _n [A]	Lamp 20 W		Lamp 50 W		
	transf.	5NZ5 071	5NZ5 081	5NZ5 072	5NZ5 081
5SX4					
Characteristic B	6	14	42	12	21
	10	23	70	20	35
	16	38	112	32	57
	20	47	141	40	71
	25	59	176	50	89
	32	76	225	65	114
	40	95	282	81	142
	50	102	302	87	153
Characteristic C	6	28	54	23	25
	10	47	90	38	41
	16	76	145	61	66
	20	95	181	76	83
	25	119	227	96	104
	32	153	290	123	133
	40	191	363	153	166
	50	239	454	192	208

Miniature Circuit-Breakers (MCBs)

General Data

Description

Protecting luminaire circuits

Max. number of fluorescent lamps

I_n [A]	Lamp	Electronic controlgear											
		full circuit 230 V single lamp ¹⁾						group circuit 230 V single lamp ²⁾					
		two lamps			two lamps			two lamps			two lamps		
5SY4, 5SY7		B	C	D	B	C	D	B	C	D	B	C	D
6	L 18 W	17	37	66	17	35	35	66	66	66	35	35	35
	L 36 W	17	37	37	17	19	19	37	37	37	19	19	19
	L 58 W	17	19	19	12	12	12	19	19	19	12	12	12
8	L 18 W	-	50	88	-	47	47	-	88	88	-	-	47
	L 36 W	-	50	50	-	25	25	-	50	50	-	25	25
	L 58 W	-	25	25	-	16	16	-	25	25	-	16	16
10	L 18 W	36	67	111	36	58	58	111	111	111	58	58	58
	L 36 W	36	62	62	32	32	32	62	62	62	32	32	32
	L 58 W	32	32	32	20	20	20	32	32	32	20	20	20
13	L 18 W	44	81	144	44	76	76	144	144	144	76	76	76
	L 36 W	44	81	81	41	41	41	81	81	81	41	41	41
	L 58 W	41	41	41	26	26	26	41	41	41	26	26	26
16	L 18 W	56	100	177	56	94	94	177	177	177	94	94	94
	L 36 W	56	100	100	51	51	51	100	100	100	51	51	51
	L 58 W	51	51	51	32	32	32	51	51	51	32	32	32
20	L 18 W	70	117	222	70	117	117	222	222	222	117	117	117
	L 36 W	70	117	125	64	64	64	125	125	125	64	64	64
	L 58 W	64	64	64	40	40	40	64	64	64	40	40	40
25	L 18 W	85	157	277	85	147	147	277	277	277	147	147	147
	L 36 W	85	156	156	80	80	80	156	156	156	80	80	80
	L 58 W	80	80	80	51	51	51	80	80	80	51	51	51
32	L 18 W	100	144	355	100	144	188	355	355	355	188	188	188
	L 36 W	100	144	200	100	103	103	200	200	200	103	103	103
	L 58 W	100	103	103	65	65	65	103	103	103	65	65	65
40	L 18 W	126	216	444	126	216	235	444	444	444	235	235	235
	L 36 W	126	216	250	126	129	129	250	250	250	129	129	129
	L 58 W	126	129	129	81	81	81	129	129	129	81	81	81
50	L 18 W	180	247	555	180	247	294	555	555	555	294	294	294
	L 36 W	180	247	312	161	161	161	312	312	312	161	161	161
	L 58 W	161	161	161	102	102	102	161	161	161	102	102	102
63	L 18 W	170	340	567	170	340	370	700	700	700	370	370	370
	L 36 W	170	340	393	170	203	203	393	393	393	203	203	203
	L 58 W	170	203	203	128	128	128	203	203	203	128	128	128

1) All electronic controlgear are switched on simultaneously.

2) The electronic controlgear are one after another switched on in groups.

Circuit impedance: The specified lamp load values are valid taking into account a cable impedance of 800 mΩ.
At 400 mΩ the permissible values are reduced by 10 %.

Reduction factors for MCBs for a simultaneous switch-on of an incandescent lamp load referred to the rated current of the MCB and the total operating current of the lamps

	Reduction factor	
	switching using MCBs	switching using a separate switch
5SQ, 5SX, 5SY, 5SP4		
Characteristic A	0.3	0.35
Characteristic B	0.5	0.6
Characteristic C	1	1
Characteristic D	1	1

Miniature Circuit-Breakers (MCBs) General Data

Description

2

Load capacity of MCBs with compensated and non-compensated HQ, HQI and NAV lamps (number)

		Lamp rating [W]							
		35	70	150	250	400	1,000	2,000	3,500
Lamp current	[A]	0.5	1	1.8	3	3.5	9.5	10.3	18
Comp. lamp current	[A]	0.3	0.5	1	1.5	2	6	5.5	9.8
Inrush	[A]	10	18	36	60	70	120	125	220

I_n [A]	Lamp rating [W]							
	35	70	150	250	400	1,000	2,000	3,500

5SX2, 5SX4									
Characteristic B	6	3	1	0	0	0	0	0	0
	10	5	2	1	0	0	0	0	0
	13	6	3	1	1	1	0	0	0
	16	8	4	2	1	1	0	0	0
	20	10	5	2	1	1	0	0	0
	25	13	7	3	2	1	1	1	0
	32	16	8	4	2	2	1	1	0
	40	20	11	5	3	3	1	1	1
	50	21	12	6	3	3	1	1	1
	Characteristic C	1	1	0	0	0	0	0	0
1.6		1	1	0	0	0	0	0	0
2		2	1	0	0	0	0	0	0
3		3	1	0	0	0	0	0	0
4		4	2	1	0	0	0	0	0
6		6	3	1	1	0	0	0	0
8		8	4	2	1	1	0	0	0
10		10	5	2	1	1	0	0	0
13		13	7	3	2	1	1	1	0
16		16	9	4	2	2	1	1	0
20		20	11	5	3	2	1	1	0
25		25	14	7	4	3	2	1	1
32		32	17	8	5	4	2	2	1
40		40	22	11	6	5	3	3	1
50		50	27	13	8	7	4	3	2
Characteristic D	1	1	0	0	0	0	0	0	0
	1.6	2	1	0	0	0	0	0	0
	2	2	1	0	0	0	0	0	0
	3	3	2	1	0	0	0	0	0
	4	5	2	1	1	0	0	0	0
	6	8	4	2	1	1	0	0	0
	8	11	5	3	2	1	0	0	0
	10	14	7	4	2	2	0	0	0
	13	18	9	5	3	2	1	1	0
	16	22	11	6	3	3	1	1	0
	20	28	14	7	4	4	1	1	0
	25	35	17	9	5	5	2	1	1
	32	44	22	12	7	6	2	2	1
	40	56	28	15	9	8	3	3	1
	50	70	35	19	11	10	4	3	2

Miniature Circuit-Breakers (MCBs)

General Data

Description

Load capacity of MCBs with compensated and non-compensated HQ, HQI and NAV lamps (number)

		Lamp rating [W]							
		35	70	150	250	400	1,000	2,000	3,500
Lamp current	[A]	0.5	1	1.8	3	3.5	9.5	10.3	18
Comp. lamp current	[A]	0.3	0.5	1	1.5	2	6	5.5	9.8
Inrush	[A]	10	18	36	60	70	120	125	220

		Lamp rating [W]							
I_n [A]		35	70	150	250	400	1,000	2,000	3,500
5SY4, 5SY7									
Characteristic B	6	2	1	0	0	0	0	0	0
	10	5	3	1	1	0	0	0	0
	13	7	4	2	1	1	0	0	0
	16	8	5	2	1	1	0	0	0
	20	11	6	3	1	1	1	1	0
	25	13	7	3	2	2	1	1	0
	32	16	8	4	2	2	1	1	0
	40	20	11	5	3	3	1	1	1
	50	28	15	7	4	4	2	2	1
	63	26	14	7	4	3	2	2	1
Characteristic C	6	6	3	1	1	0	0	0	0
	8	8	4	2	1	1	0	0	0
	10	10	6	3	1	1	0	0	0
	13	13	7	3	2	1	1	1	0
	16	16	9	4	2	2	1	1	0
	20	18	10	5	3	2	1	1	0
	25	25	14	7	4	3	2	1	1
	32	22	12	6	3	3	2	1	1
	40	33	18	9	5	4	2	2	1
	50	38	21	10	6	5	3	3	1
63	53	29	14	9	7	4	4	2	
Characteristic D	6	8	4	2	1	1	0	0	0
	8	11	5	3	2	1	0	0	0
	10	14	7	4	2	2	0	0	0
	13	18	9	5	3	2	1	1	0
	16	22	11	6	3	3	1	1	0
	20	28	14	7	4	4	1	1	0
	25	35	17	9	5	5	2	1	1
	32	44	22	12	7	6	2	2	1
	40	56	28	15	9	8	3	2	1
	50	70	35	19	11	10	4	3	2
63	88	44	24	14	12	4	4	2	
5SP4									
Characteristic C	80	76	42	21	12	11	6	6/5	3
	100	98	54	27	16	14	8/7	8/6	4
	125	116	64	32	19	16	9	9/8	5
Characteristic D	80	143/112	80/56	40/31	24/18	20/16	9/6	10/5	5/3
	100	186/140	103/70	51/39	31/23	26/20	11/7	12/6	7/4
	125	186/175	103/87	51/48	31/29	26/25	14/9	15/8	8/5

Compensated/non-compensated lamps are subject to different values.

Voltage-independent, selective main miniature circuit-breakers (SHU)

According to DIN VDE 0645 Selective main miniature circuit-breakers are essentially based on the mode of operation of conventional MCBs and have a delayed thermal release for overload protection and an electromagnetic fast release with an impact armature for short-circuit protection. Further, a selectivity device is included which identifies whether the downstream MCB in the load circuit can handle the short circuit by itself or not. For situations where the MCB cannot handle the short circuit, the selective main miniature circuit-breaker trips.

Independent of its rated current, the selective main miniature circuit-breaker guarantees a selectivity with regard to the downstream MCBs acc. to EN 60 898 and DIN VDE 0641 Part 11 up to their rated breaking capacity. 6 000
3

Further, the selective main miniature circuit-breaker provides back-up protection up to 25 kA for all downstream MCBs. In the past, sealed fuses were generally used at the meter panel to prevent power theft. As a result of various modes of operation and therefore different characteristics only a limited short-circuit selectivity can be achieved in a cascade of upstream fuses and downstream MCBs. This selectivity depends on the difference of the particular rated currents. If a meter fuse was blown due to an overcurrent or a short circuit, the power supply company service department had to be called-in to replace the sealed fuse because this could not be done by a non-specialist. The selective main miniature circuit-breaker, however, can be reclosed by non-specialists.

The new selective main miniature circuit-breaker offers the following advantages for the system/plant operator:

- Improved current limiting by supporting the downstream MCB using the selective main miniature circuit-breaker
- System-compatibility, as, with the exception of the downstream MCB, the operating characteristics of other devices are not influenced
- High and reliable selectivity between the sub-distribution and meter panel
- Safe, fast and economical reclosure by non-specialists
- Reclosure is not possible as long as the cause of the short circuit has not been removed
- A tariff monitoring function ensures that power taken from the line is registered
- Isolator characteristics with contact position indication according to EN 60 204.

Application examples

Selectivity with regard to downstream MCBs up to the rated breaking capacity 6 000
3

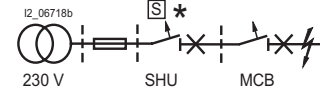

Selectivity with regard to upstream fuses up to 2 000 A

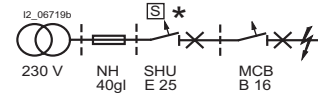

Summary of technical data

		Selective main miniature circuit-breaker
Standards		DIN VDE 0645
Tripping characteristic		E
Rated voltage	V AC	230/400
Rated breaking capacity	kA	25
Size acc. to DIN 43 880		5 when mounted on standard mounting rails acc. to DIN EN 50 022 6 when mounted on busbars using an adapter
Insulation coordination		
• Rated insulation voltage	V AC	690
• Degree of pollution for overvoltage class IV		3
Connection		Individual connection or group connection using busbars
Terminals		Saddle terminals on both ends
Cross sections		On both ends
• Stranded, max.	mm ²	70
• Finely stranded, max.	mm ²	50

Tripping characteristic E

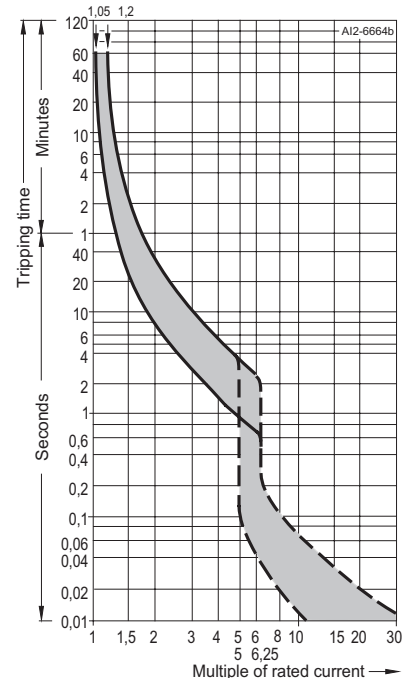

Miniature Circuit-Breakers (MCBs)

General Data

Description

DC, AC/DC

In DC networks up to 60 V or 120 V, all MCBs of the N System, are suitable for single-pole and double-pole application.

The 5SX5 design is required for higher voltages. Contrary to the standard product range, the 5SX5 are equipped with

additional permanent magnets in the quenching chamber to support arc suppression.

For this reason, the polarity of the MCB is clearly marked and must be observed when connecting the cables and conductors.

Up to max. 220 V DC battery voltage

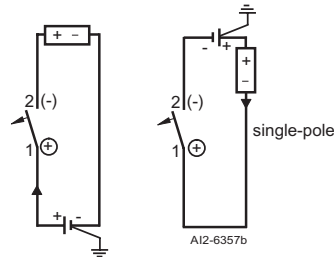

Up to max. 220 V DC battery voltage

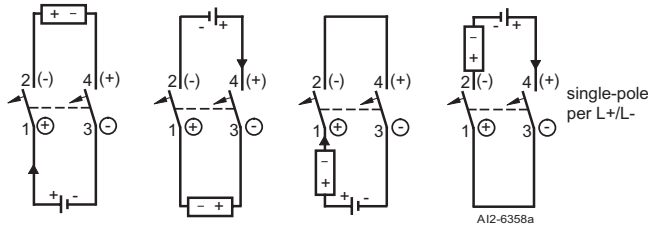

Up to max. 440 V DC battery voltage

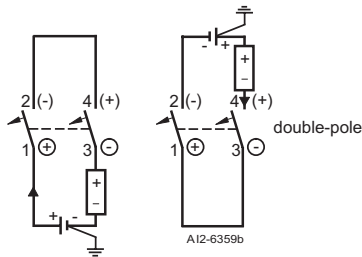

Miniature Circuit-Breakers (MCBs) Power Supply Company Product Range

5SP3 selective main miniature circuit-breakers (SHU), 25 kA

2

Features

- U_n : 230/400 V, 50-60 Hz can be used in supply networks up to 250/440 V AC
- Standards: DIN VDE 0645
- 91 mm device mounting depth.

Applications

- As main miniature circuit-breaker in meter panels.
- As group miniature circuit-breaker in distribution boards.
- Characteristic E: Adapted to the special application conditions encountered in cascade circuit configurations between fuses and MCBs.



Advantages

- Protects insulated cables against overcurrents
- Isolates loads
- Power drawn from the supply is registered
- Non-specialists can reclose the circuit
- Meets defined selectivity requirements with respect to upstream and downstream overcurrent protective devices
- Can be screwed to mounting panels
- Can be clipped onto busbars using an adapter
- Can be snapped onto mounting rails in accordance with DIN EN 50 022 using the mounting plate.

Selection and ordering data

	I_n	MW	Characteristic E	Price	Weight 1 item	Pack. unit
	A		Order No.	1 item	kg	Items
Selective main miniature circuit-breaker 	16	2	5SP3 716		0.55	3
	20		5SP3 720			
	25		5SP3 725			
	32		5SP3 732			
	35		5SP3 735			
	40		5SP3 740			
	50		5SP3 750			
	63		5SP3 763			
	80		5SP3 780			
	100		5SP3 791			

Accessories

		Order No.	Price	Weight 1 item	Pack. unit
			1 item	kg	Items
For selective main miniature circuit-breakers (SHU)   	Breaker-blocking cover prevents manual tripping of the breaker	5ST1 318		0.001	10
	Operation-blocking cover, gray prevents the manual tripping and resetting of the breaker	5ST1 320		0.002	10
	Operating protective cover, transparent several possibilities against accidental and deliberate actuation <ul style="list-style-type: none"> • with padlock • using crosstip screwdrivers • using special wrenches (Antilux) can be provided by operators and the power supply companies	5ST1 323		0.012	3

For dimension drawings see page 2/64.

Miniature Circuit-Breakers (MCBs) Power Supply Company Product Range

Accessories

General accessories



Mounting plates

for mounting onto standard mounting rails acc. to DIN EN 50 022
for 1 or 2 standard mounting rails universally applicable, 125 mm clearance

Order No.	Price	Weight 1 item	Pack. unit
	1 item	kg	Items

5ST1 322

0.021 10



Busbar adapters

suitable for 40 mm clearance to accept 3 selective main miniature circuit-breakers

5ST1 314

0.35 1



with integrated terminals 50 mm² for infeed

5ST1 315

0.65



to accept 1 selective main miniature circuit-breaker

5ST1 321

0.105



Terminals

for CU busbars 12 mm x 5 mm, for connection of N and PE conductors up to 10 mm²

8GR5 487

0.14 1



Terminal covers

2 are required per device to cover envelopes within the overall dimensions acc. to DIN 43 880

5ST1 316

0.001 6

For covering terminals and cut-out of meter panels with 125 mm clearance

5ST1 317

0.01



6 000
3

Miniature Circuit-Breakers (MCBs) N-Type Standard Product Range

5SQ3 miniature circuit breakers
6 kA, AC model

2

Features





- U_n : 230 V, 50-60 Hz
- Standards: EN 60 898, DIN VDE 0641 Part 11, IEC 60 898
- 58 mm device mounting depth
- 1+N in 1 MW for distributions with little space.

Application

Characteristic B:
Cable and line protection mainly in socket outlet circuits, proof regarding shock-hazard protection is not necessary.

Characteristic C:
Cable and line protection, especially advantageous in case of high inrush currents (lamps, motors etc.).

Selection and ordering data

	I_n	MW	Order No.	Price	Weight 1 item	Pack. unit
	A			1 item	kg	Items
Characteristic B						
	1-pole + N					
		6	1	5SQ3 560-0KV06 5SQ3 560-0KV10 5SQ3 560-0KV13 5SQ3 560-0KV16	0.216	12
		10				
		13				
		16				
Characteristic C						
	1-pole + N					
		6	1	5SQ3 570-0KV06 5SQ3 570-0KV10 5SQ3 570-0KV13 5SQ3 570-0KV16 5SQ3 570-0KV20	0.216	12
		10				
		13				
		16				
	20					

For dimension drawings and terminal connections see pages 2/63 and 2/64.

Miniature Circuit-Breakers (MCBs)

N-Type Standard Product Range

5SX2 miniature circuit-breakers 6 kA, AC model







Features

- U_n : 230/400 V, 50-60 Hz applicable in networks up to 250/440 V AC, 60 V AC per pole
- Standards: IEC 60 898, EN 60 898, DIN VDE 0641 Part 11
- 55 mm device mounting depth
- Additional components can be retrofitted.

Application

- Characteristic A:
- For limited semiconductor protection
 - Protection of measuring circuits with transformers
- Protection of circuits with long cable lengths which will require tripping within 0.4 s according to DIN VDE 0100 Part 410.

Selection and ordering data

	I_n	MW	Order No.	Price	Weight 1 item	Pack. unit	
	A			1 item	kg	Items	
Characteristic A							
	1-pole						
							
		1	1	5SX2 101-5		0.150	12
		1.6		5SX2 115-5			
		2		5SX2 102-5			
		3		5SX2 103-5			
		4		5SX2 104-5			
		6		5SX2 106-5			
		10		5SX2 110-5			
		16		5SX2 116-5			
		20		5SX2 120-5			
		25		5SX2 125-5			
		32		5SX2 132-5			
	40		5SX2 140-5				
	2-pole						
							
		1	2	5SX2 201-5		0.300	6
		1.6		5SX2 215-5			
		2		5SX2 202-5			
		3		5SX2 203-5			
		4		5SX2 204-5			
		6		5SX2 206-5			
		10		5SX2 210-5			
		16		5SX2 216-5			
		20		5SX2 220-5			
		25		5SX2 225-5			
		32		5SX2 232-5			
	40		5SX2 240-5				
	3-pole						
							
		1	3	5SX2 301-5		0.450	4
		1.6		5SX2 315-5			
		2		5SX2 302-5			
		3		5SX2 303-5			
		4		5SX2 304-5			
		6		5SX2 306-5			
		10		5SX2 310-5			
		16		5SX2 316-5			
		20		5SX2 320-5			
		25		5SX2 325-5			
		32		5SX2 332-5			
	40		5SX2 340-5				

For additional components see page 2/39.

For accessories see page 2/40 to 2/42.

For dimension drawings and terminal connections see pages 2/63 and 2/64.

6 000
3

Miniature Circuit-Breakers (MCBs) N-Type Standard Product Range









**5SX2 miniature circuit-breakers
6 kA, AC model**

2

Application

Characteristic B:
Cable and line protection mainly
in residential buildings, proof re-
garding shock-hazard protec-
tion is not necessary.

Selection and ordering data

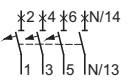
	I_n	MW	Order No.	Price	Weight 1 item	Pack. unit	
	A			1 item	kg	Items	
Characteristic B							
	1-pole						
		6	1	5SX2 106-6		0.140	12
		10		5SX2 110-6			
		13		5SX2 113-6			
		16		5SX2 116-6			
		20		5SX2 120-6			
		25		5SX2 125-6			
	32		5SX2 132-6		0.115		
	40		5SX2 140-6				
	50		5SX2 150-6				
	1-pole + N						
		6	2	5SX2 506-6		0.210	6
		10		5SX2 510-6			
		13		5SX2 513-6			
		16		5SX2 516-6			
		20		5SX2 520-6			
		25		5SX2 525-6			
	32		5SX2 532-6		0.300		
	40		5SX2 540-6				
	50		5SX2 550-6				
	2-pole						
		6	2	5SX2 206-6		0.280	6
		10		5SX2 210-6			
		13		5SX2 213-6			
		16		5SX2 216-6			
		20		5SX2 220-6			
		25		5SX2 225-6			
	32		5SX2 232-6		0.300		
	40		5SX2 240-6				
	50		5SX2 250-6				
	3-pole						
		6	3	5SX2 306-6		0.440	4
		10		5SX2 310-6			
		13		5SX2 313-6			
		16		5SX2 316-6			
		20		5SX2 320-6			
		25		5SX2 325-6			
	32 ¹⁾		5SX2 332-6		0.450		
	40		5SX2 340-6				
	50		5SX2 350-6				
	3-pole + N						
		10	4	5SX2 610-6		0.450	3
		13		5SX2 613-6			
		16		5SX2 616-6			
		20		5SX2 620-6			
		25		5SX2 625-6			
		32		5SX2 632-6			
	40		5SX2 640-6		0.610		
	50		5SX2 650-6				

The versions 5SX2 B 6 ... 50, C 0.5 ... 50 and D 0.5 ... 32 1-pole, 2-pole and 3-pole are certified acc. to UL 1077 and CSA 22.2 No. 235-M 89 and can be used as "supplementary protectors" up to 277 V AC (1-pole) and 480 V AC (2-pole, 3-pole).

For additional components see page 2/39.

For accessories see page 2/40 to 2/42.

For dimension drawings and terminal connections see pages 2/63 and 2/64.

1) Also suitable for 21 kW active power for 3-phase 400 V (e. g. continuous-flow water heaters with short-time operation) or 7 kW active power for 230 V AC (e. g. storage heater in non-continuous operation). For continuous load conditions, we recommend to use miniature circuit-breakers with characteristic B and C and $I_n = 40$ A.

Miniature Circuit-Breakers (MCBs) N-Type Standard Product Range











6 000
3

**5SX2 miniature circuit-breakers
6 kA, AC model**

Application

Characteristic C:
Cable and line protection, especially advantageous with high inrush currents (lamps, motors etc.).

Selection and ordering data

	I_n	MW	Order No.	Price	Weight 1 item	Pack. unit		
	A			1 item	kg	Items		
Characteristic C								
	1-pole							
			0.3	1	5SX2 114-7	0.140	12	
			0.5		5SX2 105-7			
			1		5SX2 101-7			
			1.6		5SX2 115-7			
			2		5SX2 102-7			
			3		5SX2 103-7			
			4		5SX2 104-7			
			6		5SX2 106-7			
			8		5SX2 108-7			
			10		5SX2 110-7			
			13		5SX2 113-7			
			16		5SX2 116-7			
			20		5SX2 120-7			
			25		5SX2 125-7			
32 ¹⁾				5SX2 132-7				
40		5SX2 140-7	0.115					
50		5SX2 150-7	0.150					
63 ²⁾		5SX2 163-7						
	1-pole + N							
			6	2	5SX2 506-7	0.210	6	
			10		5SX2 510-7			
			13		5SX2 513-7			
			16		5SX2 516-7			
			20		5SX2 520-7			
			25		5SX2 525-7			
			32		5SX2 532-7			
			40		5SX2 540-7			0.300
			50		5SX2 550-7			
			2-pole					
			0.5	2	5SX2 205-7	0.280	6	
			1		5SX2 201-7			
			1.6		5SX2 215-7			
			2		5SX2 202-7			
			3		5SX2 203-7			
			4		5SX2 204-7			
			6		5SX2 206-7			
			8		5SX2 208-7			
			10		5SX2 210-7			
			13		5SX2 213-7			
			16		5SX2 216-7			
			20		5SX2 220-7			
			25		5SX2 225-7			
			32		5SX2 232-7			
			40		5SX2 240-7			0.300
			50		5SX2 250-7			
			63 ²⁾		5SX2 263-7			

The versions 5SX2 B 6 ... 50, C 0.5 ... 50 and D 0.5 ... 32 1-pole, 2-pole and 3-pole are certified acc. to UL 1077 and CSA 22.2 No. 235-M 89 and can be used as „supplementary protectors“ up to 277 V AC (1-pole) and 480 V AC (2-pole, 3-pole).

For additional components see page 2/39.

For accessories see pages 2/40 to 2/42.

For dimension drawings and terminal connections see pages 2/63 and 2/64.

1) Also suitable for 21 kW active power for 3-phase 400 V (e. g. continuous-flow water heaters with short-time operation) or 7 kW active power for 230 V AC (e. g. storage heater in non-continuous operation). For continuous load conditions we recommend to use miniature circuit-breakers with characteristic B and C and $I_n = 40$ A.

2) Without 



6 000
3

Miniature Circuit-Breakers (MCBs) N-Type Standard Product Range

**5SX2 miniature circuit-breakers
6 kA, AC model**

2

Selection and ordering data

	I_n A	MW	Order No.	Price 1 item	Weight 1 item kg	Pack. unit Items	
Characteristic C							
	3-pole						
		0.5	3	5SX2 305-7		0.440	4
		1		5SX2 301-7			
		1.6		5SX2 315-7			
		2		5SX2 302-7			
		3		5SX2 303-7			
		4		5SX2 304-7			
		6		5SX2 306-7			
		8		5SX2 308-7			
		10		5SX2 310-7			
		13		5SX2 313-7			
		16		5SX2 316-7			
		20		5SX2 320-7			
	25		5SX2 325-7				
	32 ¹⁾		5SX2 332-7				
	40		5SX2 340-7		0.450		
	50		5SX2 350-7				
	63 ²⁾		5SX2 363-7				
	3-pole + N						
		6	4	5SX2 606-7		0.450	3
		10		5SX2 610-7			
		13		5SX2 613-7			
		16		5SX2 616-7			
		20		5SX2 620-7			
		25		5SX2 625-7			
		32		5SX2 632-7			
		40		5SX2 640-7		0.610	
		50		5SX2 650-7			
	4-pole						
		6 ²⁾	4	5SX2 406-7		0.590	3
		10 ²⁾		5SX2 410-7			
		13 ²⁾		5SX2 413-7			
		16 ²⁾		5SX2 416-7			
		20 ²⁾		5SX2 420-7			
		25 ²⁾		5SX2 425-7			
		32 ²⁾		5SX2 432-7			
		40		5SX2 440-7			
		50		5SX2 450-7			

The versions 5SX2 B 6 ... 50, C 0.5 ... 50 and D 0.5 ... 32 1-pole, 2-pole and 3-pole are certified acc. to UL 1077 and CSA 22.2 No. 235-M 89 and can be used as "supplementary protectors" up to 277 V AC (1-pole) and 480 V AC (2-pole, 3-pole).

For additional components see page 2/39.

For accessories see pages 2/40 to 2/42.

For dimension drawings and terminal connections see pages 2/63 and 2/64.

1) Also suitable for 21 kW active power for 3-phase 400 V (e. g. continuous-flow water heaters with short-time operation) or 7 kW active power for 230 V AC (e. g. storage heater in non-continuous operation). For continuous load conditions, we recommend to use miniature circuit-breakers with characteristic B and C and $I_n = 40$ A.

2) Without 

Miniature Circuit-Breakers (MCBs) N-Type Standard Product Range





6 000

**5SX2 miniature circuit-breakers
6 kA, AC model**

Application

Characteristic D:
The tripping range has been matched to applications involving equipment generating significant pulses (transformers, solenoid valves).

Selection and ordering data

	I_n	MW	Order No.	Price	Weight 1 item	Pack. unit	
	A			1 item	kg	Items	
Characteristic D							
	1-pole						
		0.5	1	5SX2 105-8		0.140	12
		1		5SX2 101-8			
		1.6		5SX2 115-8			
		2		5SX2 102-8			
		3		5SX2 103-8			
		4		5SX2 104-8			
		6		5SX2 106-8			
		8		5SX2 108-8			
		10		5SX2 110-8			
		13		5SX2 113-8			
		16		5SX2 116-8			
		20		5SX2 120-8		0.150	
		25		5SX2 125-8			
	32		5SX2 132-8		0.140		
	40 ¹⁾		5SX2 140-8		0.150		
	50 ¹⁾		5SX2 150-8				
	2-pole						
		0.5	2	5SX2 205-8		0.280	6
		1		5SX2 201-8			
		1.6		5SX2 215-8			
		2		5SX2 202-8			
		3		5SX2 203-8			
		4		5SX2 204-8			
		6		5SX2 206-8			
		8		5SX2 208-8			
		10		5SX2 210-8			
		13		5SX2 213-8			
		16		5SX2 216-8			
		20		5SX2 220-8			
		25		5SX2 225-8			
	32		5SX2 232-8				
	40 ¹⁾		5SX2 240-8		0.300		
	50 ¹⁾		5SX2 250-8				
	3-pole						
		0.5	3	5SX2 305-8		0.440	4
		1		5SX2 301-8			
		1.6		5SX2 315-8			
		2		5SX2 302-8			
		3		5SX2 303-8			
		4		5SX2 304-8			
		6		5SX2 306-8			
		8		5SX2 308-8			
		10		5SX2 310-8			
		13		5SX2 313-8			
		16		5SX2 316-8			
		20		5SX2 320-8			
		25		5SX2 325-8		0.450	
	32		5SX2 332-8		0.440		
	40 ¹⁾		5SX2 340-8		0.450		
	50 ¹⁾		5SX2 350-8				

The versions 5SX2 B 6 ... 50, C 0.5 ... 50 and D 0.5 ... 32 1-pole, 2-pole and 3-pole are certified acc. to UL 1077 and CSA 22.2 No. 235-M 89 and can be used as "supplementary protectors" up to 27 V AC (1-pole) and 480 V AC (2-pole, 3-pole).

[For additional components see page 2/39.](#)

[For accessories see pages 2/40 to 2/42.](#)

[For dimension drawings and terminal connections see pages 2/63 and 2/64.](#)

1) Rated breaking capacity 4,500 A.

10 000
3

Miniature Circuit-Breakers (MCBs) N-Type Standard Product Range

5SX4 miniature circuit-breakers
10 kA, AC model

2





Features

- U_n : 230/400 V, 50-60 Hz applicable in networks up to 250/440 V AC, 60 V AC per pole
- Standards: IEC 60 898, EN 60 898, DIN VDE 0641 Part 11
- 55 mm device mounting depth

Application

Characteristic B:
Cable and line protection mainly in socket outlet circuits, proof regarding shock-hazard protection is not necessary.

Selection and ordering data

	I_n	MW	Order No.	Price	Weight 1 item	Pack. unit
	A			1 item	kg	Items
Characteristic B						
	1-pole					
	$\times 2$	6	1	5SX4 106-6	0.140	12
	1	10	5SX4 110-6			
		13	5SX4 113-6			
		16	5SX4 116-6			
		20	5SX4 120-6			
	25	5SX4 125-6				
	32 ¹⁾		5SX4 132-6	0.115		
	40		5SX4 140-6			
	50		5SX4 150-6			
	1-pole + N					
	$\times 2$ $\times N/14$	6	2	5SX4 506-6	0.210	6
	1 $N/13$	10	5SX4 510-6			
		13	5SX4 513-6			
		16	5SX4 516-6			
		20	5SX4 520-6			
	25	5SX4 525-6				
	32		5SX4 532-6	0.280	6	
	40		5SX4 540-6			
	50		5SX4 550-6			
	2-pole					
	$\times 2$ $\times 4$	6	2	5SX4 206-6	0.280	6
	1 3	10	5SX4 210-6			
		13	5SX4 213-6			
		16	5SX4 216-6			
		20	5SX4 220-6			
	25	5SX4 225-6				
	32		5SX4 232-6	0.440	4	
	40		5SX4 240-6			
	50		5SX4 250-6			
	3-pole					
	$\times 2$ $\times 4$ $\times 6$	6	3	5SX4 306-6	0.440	4
	1 3 5	10	5SX4 310-6			
		13	5SX4 313-6			
		16	5SX4 316-6			
		20	5SX4 320-6			
	25	5SX4 325-6				
	32 ¹⁾		5SX4 332-6	0.450		
	40		5SX4 340-6			
	50		5SX4 350-6			
	3-pole + N					
	$\times 2$ $\times 4$ $\times 6$ $\times N/14$	10	4	5SX4 610-6	0.450	3
	1 3 5 $N/13$	13	5SX4 613-6			
		16	5SX4 616-6			
		20	5SX4 620-6			
		25	5SX4 625-6			
	32		5SX4 632-6	0.610		
	40		5SX4 640-6			
	50		5SX4 650-6			

For additional components see page 2/39.

For accessories see pages 2/40 to 2/42.

For dimension drawings and terminal connections see pages 2/63 and 2/64.

1) Also suitable for 21 kW active power for 3-phase 400 V (e. g. continuous-flow water heaters with short-time operation) or 7 kW active power for 230 V AC (e. g. storage heater in non-continuous operation). For continuous load conditions, we recommend to use miniature circuit-breakers with characteristic B and C and $I_n = 40$ A.

Miniature Circuit-Breakers (MCBs) N-Type Standard Product Range









10 000
3

**5SX4 miniature circuit-breakers
10 kA, AC model**

Application

Characteristic C:
Cable and line protection, especially advantageous with high inrush currents (lamps, motors etc.).

Selection and ordering data

		I_n	MW	Order No.	Price	Weight 1 item	Pack. unit
		A			1 item	kg	Items
Characteristic C							
	1-pole						
		0.5	1	5SX4 105-7		0.140	12
		1		5SX4 101-7			
		1.6		5SX4 115-7			
		2		5SX4 102-7			
		3		5SX4 103-7			
		4		5SX4 104-7			
		6		5SX4 106-7			
		8		5SX4 108-7			
		10		5SX4 110-7			
		13		5SX4 113-7			
		16		5SX4 116-7			
		20		5SX4 120-7			
	25		5SX4 125-7				
	32 ¹⁾		5SX4 132-7				
	40		5SX4 140-7			0.115	
	50		5SX4 150-7				
	1-pole + N						
		6	2	5SX4 506-7		0.210	6
		10		5SX4 510-7			
		13		5SX4 513-7			
		16		5SX4 516-7			
		20		5SX4 520-7			
		25		5SX4 525-7			
	32		5SX4 532-7				
	40		5SX4 540-7			0.300	
	50		5SX4 550-7				
	2-pole						
		0.5	2	5SX4 205-7		0.280	6
		1		5SX4 201-7			
		1.6		5SX4 215-7			
		2		5SX4 202-7			
		3		5SX4 203-7			
		4		5SX4 204-7			
		6		5SX4 206-7			
		8		5SX4 208-7			
		10		5SX4 210-7			
		13		5SX4 213-7			
		16		5SX4 216-7			
		20		5SX4 220-7			
		25		5SX4 225-7			
		32		5SX4 232-7			
	40		5SX4 240-7			0.300	
	50		5SX4 250-7				

For additional components see page 2/39.

For accessories see pages 2/40 to 2/42.

For dimension drawings and terminal connections see pages 2/63 und 2/64.

1) Also suitable for 21 kW active power for 3-phase 400 V (e. g. continuous-flow water heaters with short-time operation) or 7 kW active power for 230 V AC (e. g. storage heater in non-continuous operation). For continuous load conditions, we recommend to use miniature circuit-breakers with characteristic B and C and $I_n = 40$ A.



10 000
3

Miniature Circuit-Breakers (MCBs) N-Type Standard Product Range

5SX4 miniature circuit-breakers
10 kA, AC model

2

Selection and ordering data

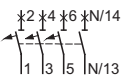
Characteristic C	I_n	MW	Order No.	Price	Weight	Pack.
	A			1 item	1 item	unit
					kg	Items
 <p>3-pole</p> 	0.5	3	5SX4 305-7 5SX4 301-7 5SX4 315-7 5SX4 302-7 5SX4 303-7 5SX4 304-7 5SX4 306-7 5SX4 308-7 5SX4 310-7 5SX4 313-7 5SX4 316-7 5SX4 320-7 5SX4 325-7 5SX4 332-7 5SX4 340-7 5SX4 350-7		0.440	4
	1					
	1.6					
	2					
	3					
	4					
	6					
	8					
	10					
	13					
	16					
	20					
	25					
	32 ¹⁾					
	40					
50						
 <p>3-pole + N</p> 	6	4	5SX4 606-7 5SX4 610-7 5SX4 613-7 5SX4 616-7 5SX4 620-7 5SX4 625-7 5SX4 632-7 5SX4 640-7 5SX4 650-7		0.450	3
	10					
	13					
	16					
	20					
	25					
	32					
	40					
	50					

For additional components see page 2/39.

For accessories see pages 2/40 to 2/42.

For dimension drawings and terminal connections see pages 2/63 und 2/64.

1) Also suitable for 21 kW active power for 3-phase 400 V (e. g. continuous-flow water heaters with short-time operation) or 7 kW active power for 230 V AC (e. g. storage heater in non-continuous operation). For continuous load conditions, we recommend to use miniature circuit-breakers with characteristic B and C and $I_n = 40$ A.

Miniature Circuit-Breakers (MCBs) N-Type AC/DC Product Range

4 500
3
10 000 T4

5SX5 miniature circuit-breakers
10 kA, 4.5 kA





Features

- U_n : 230/400 V, 50-60 Hz, 220 V DC per pole applicable in networks up to 250/440 V AC
- 220 V DC: 1-pole
- 440 V DC: 2-pole
- Additional components can be retrofitted.

Application

Characteristic B:
Cable and line protection mainly in socket outlet circuits, proof regarding shock-hazard protection is not necessary.

Characteristic C:
Cable and line protection, especially advantageous with high inrush currents (lamps, motors etc.).

	I_n A	MW	Order No.	Price 1 item	Weight 1 item kg	Pack. unit Items
Characteristic B						
	1-pole					
		6	1	5SX5 106-6		0.145 12
		10		5SX5 110-6		
		13		5SX5 113-6		
		16		5SX5 116-6		
		20		5SX5 120-6		
		25		5SX5 125-6		
	32		5SX5 132-6			
	2-pole					
		6	2	5SX5 206-6		0.290 6
		10		5SX5 210-6		
		13		5SX5 213-6		
		16		5SX5 216-6		
		20		5SX5 220-6		
		25		5SX5 225-6		
	32		5SX5 232-6			
Characteristic C						
	1-pole					
		0.5	1	5SX5 105-7		0.145 12
		1		5SX5 101-7		
		1.6		5SX5 115-7		
		2		5SX5 102-7		
		3		5SX5 103-7		
		4		5SX5 104-7		
		6		5SX5 106-7		
		8		5SX5 108-7		
		10		5SX5 110-7		
		13		5SX5 113-7		
		16		5SX5 116-7		
		20		5SX5 120-7		
	25		5SX5 125-7			
	32		5SX5 132-7			
	2-pole					
		0.5	2	5SX5 205-7		0.290 6
		1		5SX5 201-7		
		1.6		5SX5 215-7		
		2		5SX5 202-7		
		3		5SX5 203-7		
		4		5SX5 204-7		
		6		5SX5 206-7		
		8		5SX5 208-7		
		10		5SX5 210-7		
		13		5SX5 213-7		
		16		5SX5 216-7		
		20		5SX5 220-7		
	25		5SX5 225-7			
	32		5SX5 232-7			

Rated currents 40 A, 50 A on request.
For additional components see page 2/39.
For accessories see pages 2/40 to 2/42.
For dimension drawings and terminal connections see pages 2/63 and 2/64.

Miniature Circuit-Breakers (MCBs) N-Type Standard and AC/DC Product Range

Additional components for 5SX2, 5SX4, 5SX5 miniature circuit-breakers

2

Additional components

- Can be retrofitted
- Can be connected to *instabus EIB* and AS-Interface bus via binary inputs.

Auxiliary switch (AS) and fault signal contact (FC)

- Mounting with factory-installed clips
- Max. contact load:
6 A, 230 V AC, AC-15
1 A, 220 V DC, DC-13
acc. to DIN VDE 0660 Part 200, EN 60 947-5-1
- Short-circuit protection due to the 5SX miniature circuit-breaker depending on the version ...-6, -7 with $I_n = 6$ A of fuse gL 6 A.

Application

Remote display of the switching status of the miniature circuit-breaker

- AS: ON/OFF
- FC: tripped.

Shunt trip (ST)

- Mounting with attached screws
- Suitable for voltages from 110 to 415 V AC
- Short-circuit protection due to the 5SX...-7 MCBs with $I_n \geq 16$ A

Application

- Remote controlled release of the MCB.

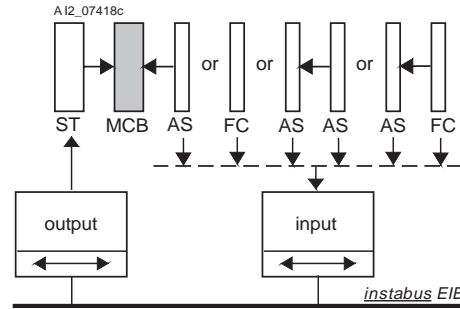

MW	Order No.	Price	Weight 1 item	Pack. unit
		1 item	kg	Items

Auxiliary switches and fault signal contacts



Auxiliary switches (AS)

	1 NO + 1 NC	0.5	5SX9 100	0.040	1
	2 NO		5SX9 101		
	2 NC		5SX9 102		

Fault signal contacts (FC)

	1 NO + 1 NC	0.5	5SX9 200	0.040	1
	2 NO		5SX9 201		
	2 NC		5SX9 202		

Shunt trips (ST) 100% ED

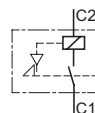

1

5SX9 300

0.141 1

For dimension drawings and terminal connections see pages 2/63 to 2/64.

Miniature Circuit-Breakers (MCBs) N-Type Standard and AC/DC Product Range

Accessories for 5SX2, 5SX4, 5SX5 miniature circuit-breakers

5ST2 1 Busbar system

Features

- Acc. to DIN 57 606 and DIN 57 659

- Load at infeed at one end/centered
50 A/90 A for 10 mm²
65 A/120 A for 16 mm²

- Single- and multi-phase
• Cu 10 mm² and 16 mm² fully insulated

- 18 mm lug spacing
• For connection at the bottom, no additional terminal is required.

	Length mm	Order No.	Price	Weight	Pack. unit Items
Cu busbars 10 mm²			1 item	1 item	
	With end caps				
	1-phase	210	5ST2 137	0.090	25
	2-phase		5ST2 138	0.100	10
	Without end caps				
	1-phase	1,000	5ST2 146	0.410	10
	2-phase		5ST2 147	0.520	5
	3-phase		5ST2 148	0.840	10
Cu busbar 16 mm²			1 item	1 item	
	With end caps				
	1-phase	210	5ST2 142	0.100	25
	2-phase		5ST2 143	0.150	10
	3-phase		5ST2 144	0.230	
	Without end caps				
	1-phase	1,000	5ST2 151	0.490	10
	2-phase		5ST2 152	0.700	5
	3-phase		5ST2 153	1.100	10
	3-phase + N		5ST2 154	1.500	5
	Without end caps				
	lug spacing is adapted to the busbar of devices				
	1-pole, 2-pole, 3-pole with 1 auxiliary switch each				
	1-phase + AS	1,000	5ST2 163	0.460	5
	2-phase + AS		5ST2 164	0.900	5
	3-phase + AS		5ST2 165	1.490	10
End caps and terminals			1 item	1 item	
	Required to isolate the ends of cut-to-length busbars				
	1- and 2-phase		5ST2 155	0.013	10
	Terminals up to 35 mm² (stranded)				
	for direct infeed into miniature circuit-breakers from the top or the bottom, can be mounted side by side				
	for busbar 1- and 2-phase		5ST2 166	0.002	10
	for busbar 3- and 4-phase		5ST2 167		
	Terminal 35 mm² (stranded)				
	for direct infeed into the busbar system side-by-side mounting				
			100 items	100 items	
		5ST2 157		3.000	10

For application examples of busbars see page 2/5.

Miniature Circuit-Breakers (MCBs) N-Type Standard and AC/DC Product Range

Accessories for 5SX2, 5SX4, 5SX5
miniature circuit-breakers

2

5ST2 4 busbar system

Features







- According to IEC 60 664, 500 V (40 °C), fully-insulated
- Load at central infeed: 1-phase up to 70 A 2- to 4-phase up to 120 A.

Application

- Any length can be attained by combining the 3 fixed busbar lengths
- A favorable current and temperature conduction is achieved by overlapping of individual elements

- Time consuming work such as cutting, cutting to length, deburring and cleaning cut surfaces and mounting end caps are all eliminated

- Reliable shock-hazard protection of connections which are not used.

	Order No.	Price	Weight 1 item	Pack. unit	
Number of circuits		1 item	kg	Items	
Cu Busbars					
	1-phase busbar				
	2 x 1	5ST2 400		0.006	20
	6 x 1	5ST2 401		0.017	
	12 x 1	5ST2 402		0.033	
	2 x (1 + AS/FC)	5ST2 403		0.008	
	6 x (1 + AS/FC)	5ST2 404		0.024	
9 x (1 + AS/FC)	5ST2 405		0.035		
	2-phase busbar				
	2 x 2	5ST2 406		0.011	10
	3 x 2	5ST2 407		0.017	
	6 x 2	5ST2 408		0.033	
	2 x (2 + AS/FC)	5ST2 410		0.023	
	3 x (2 + AS/FC)	5ST2 411		0.034	
5 x (2 + AS/FC)	5ST2 412		0.056		
	3-phase busbar				
	2 x 3	5ST2 413		0.037	10
	3 x 3	5ST2 414		0.055	
	4 x 3	5ST2 415		0.086	
	2 x (3 + AS/FC)	5ST2 416		0.057	
	3 x (3 + AS/FC)	5ST2 417		0.065	
	2 x (3 x (1 + AS/FC))	5ST2 418		0.057	
	3 x (3 x (1 + AS/FC))	5ST2 420		0.086	
3-phase busbar, for a 5SM1 RCCB 4-pole with 8 miniature circuit-breakers					
3/N + 8 connections	5ST2 424		0.091	5	
	4-phase busbar				
	2 x 4	5ST2 421		0.046	5
	3 x 4	5ST2 422		0.090	
2 x 3 x (1 + N)	5ST2 423		0.073		
	Feeder terminal				
	for side-by-side mounting, for infeed into the 35 mm ² busbar system (stranded)	5ST2 425		0.024	10
	Shock-hazard protection				
	for free connections, yellow (RAL 1004)	5ST2 426		0.004	

Miniature Circuit-Breakers (MCBs) N-Type Standard and AC/DC Product Range

Accessories for 5SX2, 5SX4, 5SX5
miniature circuit-breakers

Mounting and cover parts



	Length mm	Order No.	Price	Weight kg	Pack. unit Items
Cable links					
6 mm ² cross section end sleeves on both ends, 5SX MCBs					
	125	5ST1 292	100 items	0.850	50
	250	5ST1 293		1.700	50
Snap-on terminal					
for 16 mm ² solid or 10 mm ² stranded width 0.5 MW					
		5ST2 112		0.840	50
Spacer					
(contour of N-type MCB, 0.5 MW)					
		5ST2 122		0.900	10
Packer					
to increase the height from 53 to 60 mm snap-snap adapter 1 MW					
		5ST2 120		0.200	10
Fixing parts					
1 MW (sheet metal)					
		5ST2 121	1 item	1.700	10
4 MW (plastic)					
		5ST2 201		0.012	20
Handle locking device					
for 1-pole 5SX N-type MCBs for protecting against unintended mechanical switching (red part) disconnection (transparent part)					
		5ST2 168 5ST2 170	1 item	0.007	1
Terminal cover, gray					
surface mounting, degree of protection IP 40 with 35 mm standard mounting rail, sealable up to 2.5 MW up to 4.5 MW					
		5SW3 004 5SW3 005		0.090 0.120	10 5
flush mounting, degree of protection IP 40 with 35 mm standard mounting rail up to 2.5 MW up to 4.5 MW					
		5SW3 006 5SW3 007		0.130 0.150	10 5
Molded-plastic enclosure					
surface mounting, IP 54 with 35 mm stan- dard mounting rail, sealable with transparent flap up to 4.5 MW					
		5SW1 200		0.500	1
Cover					
for assembly of mini distribution boards cover parts are prepared for mounting of standard label caps consisting of					
		5ST2 134		0.022	10
• end plate (can be snapped onto standard mounting rail)					
		5ST2 135		0.330	5
• angled profile (approx. 1 m long)					
		5ST2 136		0.260	
• or alternatively flat profile (as cover be- tween the rows of devices).					



10 000
3

Miniature Circuit-Breakers (MCBs) Industry Guard Product Range

5SY4 miniature circuit-breakers
10 kA, AC model

2



Features

- U_n : 230/400 V, 50-60 Hz applicable in networks up to 250/440 V AC, 60 V DC per pole
- Standards: EN 60 898, DIN VDE 0641 Part 11, IEC 60 898
- 70 mm device mounting depth
- Additional components can be retrofitted.

Application

- Characteristic A:
- For limited semiconductor protection
 - Protection of measuring circuits with transformers
 - Protection of circuits with long cable lengths which will require tripping within 0.4 s according to DIN VDE 0100 Part 410.

Selection and ordering data

	I_n	MW	Order No.	Price	Weight 1 item	Pack. unit	
	A			1 item	kg	Items	
Characteristic A							
	1-pole						
		1		5SY4 101-5		0.147	12
		1.6		5SY4 115-5			
		2		5SY4 102-5			
		3		5SY4 103-5			
		4		5SY4 104-5			
		6		5SY4 106-5			
		8		5SY4 108-5			
		10		5SY4 110-5			
		13		5SY4 113-5			
		16		5SY4 116-5			
		20		5SY4 120-5			
		25		5SY4 125-5			
		32		5SY4 132-5			
	40		5SY4 140-5				
	50		5SY4 150-5				
	63		5SY4 163-5				
	1-pole + N						
		1		5SY4 501-5		0.304	6
		1.6		5SY4 515-5			
		2		5SY4 502-5			
		3		5SY4 503-5			
		4		5SY4 504-5			
		6		5SY4 506-5			
		8		5SY4 508-5			
		10		5SY4 510-5			
		13		5SY4 513-5			
		16		5SY4 516-5			
		20		5SY4 520-5			
		25		5SY4 525-5			
		32		5SY4 532-5			
	40		5SY4 540-5				
	50		5SY4 550-5				
	63		5SY4 563-5				
	2-pole						
		1		5SY4 201-5		0.304	6
		1.6		5SY4 215-5			
		2		5SY4 202-5			
		3		5SY4 203-5			
		4		5SY4 204-5			
		6		5SY4 206-5			
		8		5SY4 208-5			
		10		5SY4 210-5			
		13		5SY4 213-5			
		16		5SY4 216-5			
		20		5SY4 220-5			
		25		5SY4 225-5			
		32		5SY4 232-5			
	40		5SY4 240-5				
	50		5SY4 250-5				
	63		5SY4 263-5				

For additional components see pages 2/60 and 2/61.
For accessories see pages 2/55 and 2/60
For dimension drawings see page 2/64.







Miniature Circuit-Breakers (MCBs) Industry Guard Product Range

10 000
3



**5SY4 miniature circuit-breakers
10 kA, AC model**

Selection and ordering data

		I_n	MW	Order No.	Price	Weight 1 item	Pack. unit
Characteristic A		A			1 item	kg	Items
	3-pole 	1		5SY4 301-5		0.456	4
		1.6		5SY4 315-5			
		2		5SY4 302-5			
		3		5SY4 303-5			
		4		5SY4 304-5			
		6		5SY4 306-5			
		8		5SY4 308-5			
		10		5SY4 310-5			
		13		5SY4 313-5			
		16		5SY4 316-5			
		20		5SY4 320-5			
		25		5SY4 325-5			
		32		5SY4 332-5			
		40		5SY4 340-5			
		50		5SY4 350-5			
63		5SY4 363-5					
	3-pole + N 	1		5SY4 601-5		0.608	3
		1.6		5SY4 615-5			
		2		5SY4 602-5			
		3		5SY4 603-5			
		4		5SY4 604-5			
		6		5SY4 606-5			
		8		5SY4 608-5			
		10		5SY4 610-5			
		13		5SY4 613-5			
		16		5SY4 616-5			
		20		5SY4 620-5			
		25		5SY4 625-5			
		32		5SY4 632-5			
		40		5SY4 640-5			
		50		5SY4 650-5			
63		5SY4 663-5					
	4-pole 	1		5SY4 401-5		0.608	3
		1.6		5SY4 415-5			
		2		5SY4 402-5			
		3		5SY4 403-5			
		4		5SY4 404-5			
		6		5SY4 406-5			
		8		5SY4 408-5			
		10		5SY4 410-5			
		13		5SY4 413-5			
		16		5SY4 416-5			
		20		5SY4 420-5			
		25		5SY4 425-5			
		32		5SY4 432-5			
		40		5SY4 440-5			
		50		5SY4 450-5			
63		5SY4 463-5					

For additional components see pages 2/60 and 2/61.
 For accessories see pages 2/55 and 2/60.
 For dimension drawings and terminal connections see page 2/64.

Footnote referring to page 2/45:

- Also suitable for 21 kW active power for 3-phase 400 V (e. g. continuous-flow water heater with short time operation) or 7 kW active power with 230 V AC (e. g. storage heater in non-continuous operation). For continuous load conditions, we recommend to use miniature circuit-breakers with characteristic B and C and $I_n = 40$ A.



10 000
3

Miniature Circuit-Breakers (MCBs) Industry Guard Product Range

5SY4 miniature circuit-breakers
10 kA, AC model







2

Application

Characteristic B:
Cable and line protection mainly
in residential building install-

ations, no proof concerning per-
sonnel protection required.

Selection and ordering data

	I_n	MW	Order No.	Price	Weight 1 item	Pack. unit	
	A			1 item	kg	Items	
Characteristic B							
	1-pole						
		6	1	5SY4 106-6		0.147	12
		10		5SY4 110-6			
		13		5SY4 113-6			
		16		5SY4 116-6			
		20		5SY4 120-6			
		25		5SY4 125-6			
		32 ¹⁾		5SY4 132-6			
	40		5SY4 140-6				
	50		5SY4 150-6				
	63		5SY4 163-6				
	1-pole + N						
		6	2	5SY4 506-6		0.304	6
		10		5SY4 510-6			
		13		5SY4 513-6			
		16		5SY4 516-6			
		20		5SY4 520-6			
		25		5SY4 525-6			
		32		5SY4 532-6			
	40		5SY4 540-6				
	50		5SY4 550-6				
	63		5SY4 563-6				
	2-pole						
		6	2	5SY4 206-6		0.304	6
		10		5SY4 210-6			
		13		5SY4 213-6			
		16		5SY4 216-6			
		20		5SY4 220-6			
		25		5SY4 225-6			
		32		5SY4 232-6			
	40		5SY4 240-6				
	50		5SY4 250-6				
	63		5SY4 263-6				
	3-pole						
		6	3	5SY4 306-6		0.456	4
		10		5SY4 310-6			
		13		5SY4 313-6			
		16		5SY4 316-6			
		20		5SY4 320-6			
		25		5SY4 325-6			
		32		5SY4 332-6			
	40		5SY4 340-6				
	50		5SY4 350-6				
	63		5SY4 363-6				
	3-pole + N						
		6	4	5SY4 606-6		0.608	3
		10		5SY4 610-6			
		13		5SY4 613-6			
		16		5SY4 616-6			
		20		5SY4 620-6			
		25		5SY4 625-6			
		32		5SY4 632-6			
	40		5SY4 640-6				
	50		5SY4 650-6				
	63		5SY4 663-6				
	4-pole						
		6	4	5SY4 406-6		0.608	3
		10		5SY4 410-6			
		13		5SY4 413-6			
		16		5SY4 416-6			
		20		5SY4 420-6			
		25		5SY4 425-6			
		32		5SY4 432-6			
	40		5SY4 440-6				
	50		5SY4 450-6				
	63		5SY4 463-6				

Miniature Circuit-Breakers (MCBs) Industry Guard Product Range



10 000
3









5SY4 miniature circuit-breakers 10 kA, AC model

Application

Characteristic C: inrush currents (lamps, motors etc.).
Cable and line protection, especially advantageous with high

Selection and ordering data

	I_n	MW	Order No.	Price	Weight 1 item	Pack. unit
Characteristic C	A			1 item	kg	Items
 <p>1-pole</p> 	0.3	1	5SY4 114-7		0.147	12
	0.5		5SY4 105-7			
	1		5SY4 101-7			
	1.6		5SY4 115-7			
	2		5SY4 102-7			
	3		5SY4 103-7			
	4		5SY4 104-7			
	6		5SY4 106-7			
	8		5SY4 108-7			
	10		5SY4 110-7			
	13		5SY4 113-7			
	16		5SY4 116-7			
	20		5SY4 120-7			
	25		5SY4 125-7			
	32 ¹⁾		5SY4 132-7			
40	5SY4 140-7					
50	5SY4 150-7					
63	5SY4 163-7					
 <p>1-pole + N</p> 	0.3	2	5SY4 514-7		0.304	6
	0.5		5SY4 505-7			
	1		5SY4 501-7			
	1.6		5SY4 515-7			
	2		5SY4 502-7			
	3		5SY4 503-7			
	4		5SY4 504-7			
	6		5SY4 506-7			
	8		5SY4 508-7			
	10		5SY4 510-7			
	13		5SY4 513-7			
	16		5SY4 516-7			
	20		5SY4 520-7			
	25		5SY4 525-7			
	32		5SY4 532-7			
40	5SY4 540-7					
50	5SY4 550-7					
63	5SY4 563-7					
 <p>2-pole</p> 	0.3	2	5SY4 214-7		0.304	6
	0.5		5SY4 205-7			
	1		5SY4 201-7			
	1.6		5SY4 215-7			
	2		5SY4 202-7			
	3		5SY4 203-7			
	4		5SY4 204-7			
	6		5SY4 206-7			
	8		5SY4 208-7			
	10		5SY4 210-7			
	13		5SY4 213-7			
	16		5SY4 216-7			
	20		5SY4 220-7			
	25		5SY4 225-7			
	32		5SY4 232-7			
40	5SY4 240-7					
50	5SY4 250-7					
63	5SY4 263-7					

For additional components see pages 2/60 and 2/61.
For accessories see pages 2/55 and 2/60.
For dimension drawings see page 2/64.

1) Also suitable for 21 kW active power for 3-phase 400 V (e. g. continuous-flow water heater with short time operation) or 7 kW active power with 230 V AC (e. g. storage heater in non-continuous operation). For continuous load conditions, we recommend to use miniature circuit-breakers with characteristic B and C and $I_n = 40$ A.







10 000
3

Miniature Circuit-Breakers (MCBs) Industry Guard Product Range

5SY4 miniature circuit-breakers
10 kA, AC model

2

Selection and ordering data

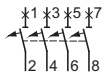
	I_n	MW	Order No.	Price	Weight 1 item	Pack. unit
Characteristic C	A			1 item	kg	Items
 <p>3-pole</p> 	0.3	3	5SY4 314-7		0.456	4
	0.5		5SY4 305-7			
	1		5SY4 301-7			
	1.6		5SY4 315-7			
	2		5SY4 302-7			
	3		5SY4 303-7			
	4		5SY4 304-7			
	6		5SY4 306-7			
	8		5SY4 308-7			
	10		5SY4 310-7			
	13		5SY4 313-7			
	16		5SY4 316-7			
	20		5SY4 320-7			
	25		5SY4 325-7			
	32 ¹⁾		5SY4 332-7			
	40		5SY4 340-7			
50	5SY4 350-7					
63	5SY4 363-7					
 <p>3-pole + N</p> 	0.3	4	5SY4 614-7		0.608	3
	0.5		5SY4 605-7			
	1		5SY4 601-7			
	1.6		5SY4 615-7			
	2		5SY4 602-7			
	3		5SY4 603-7			
	4		5SY4 604-7			
	6		5SY4 606-7			
	8		5SY4 608-7			
	10		5SY4 610-7			
	13		5SY4 613-7			
	16		5SY4 616-7			
	20		5SY4 620-7			
	25		5SY4 625-7			
	32		5SY4 632-7			
	40		5SY4 640-7			
50	5SY4 650-7					
63	5SY4 663-7					
 <p>4-pole</p> 	0.3	4	5SY4 414-7		0.608	3
	0.5		5SY4 405-7			
	1		5SY4 401-7			
	1.6		5SY4 415-7			
	2		5SY4 402-7			
	3		5SY4 403-7			
	4		5SY4 404-7			
	6		5SY4 406-7			
	8		5SY4 408-7			
	10		5SY4 410-7			
	13		5SY4 413-7			
	16		5SY4 416-7			
	20		5SY4 420-7			
	25		5SY4 425-7			
	32		5SY4 432-7			
	40		5SY4 440-7			
50	5SY4 450-7					
63	5SY4 463-7					

For additional components see pages 2/60 and 2/61.
For accessories see pages 2/55 and 2/60.
For dimension drawings and terminal connections see page 2/64.

1) Also suitable for 21 kW active power for 3-phase 400 V (e. g. continuous-flow water heater with short time operation) or 7 kW active power with 230 V AC (e. g. storage heater in non-continuous operation). For continuous load conditions, we recommend to use miniature circuit-breakers with characteristic B and C and $I_n = 40$ A.

Miniature Circuit-Breakers (MCBs) Industry Guard Product Range



10 000
3









5SY4 miniature circuit-breakers 10 kA, AC model

Application

Characteristic D:
The tripping range has been matched to applications involving equipment generating significant pulses (transformers, solenoid valves).

Selection and ordering data

	I_n	MW	Order No.	Price	Weight 1 item	Pack. unit	
	A			1 item	kg	Items	
Characteristic D							
	1-pole						
			0.3	1	5SY4 114-8	0.147	12
			0.5		5SY4 105-8		
			1		5SY4 101-8		
			1.6		5SY4 115-8		
			2		5SY4 102-8		
			3		5SY4 103-8		
			4		5SY4 104-8		
			6		5SY4 106-8		
			8		5SY4 108-8		
			10		5SY4 110-8		
			13		5SY4 113-8		
			16		5SY4 116-8		
20				5SY4 120-8			
25		5SY4 125-8					
32		5SY4 132-8					
40		5SY4 140-8					
50		5SY4 150-8					
63		5SY4 163-8					
	1-pole + N						
		0.3	2	5SY4 514-8	0.304	6	
		0.5		5SY4 505-8			
		1		5SY4 501-8			
		1.6		5SY4 515-8			
		2		5SY4 502-8			
		3		5SY4 503-8			
		4		5SY4 504-8			
		6		5SY4 506-8			
		8		5SY4 508-8			
		10		5SY4 510-8			
		13		5SY4 513-8			
		16		5SY4 516-8			
20			5SY4 520-8				
25		5SY4 525-8					
32		5SY4 532-8					
40		5SY4 540-8					
50		5SY4 550-8					
63		5SY4 563-8					
	2-pole						
		0.3	2	5SY4 214-8	0.304	6	
		0.5		5SY4 205-8			
		1		5SY4 201-8			
		1.6		5SY4 215-8			
		2		5SY4 202-8			
		3		5SY4 203-8			
		4		5SY4 204-8			
		6		5SY4 206-8			
		8		5SY4 208-8			
		10		5SY4 210-8			
		13		5SY4 213-8			
		16		5SY4 216-8			
20			5SY4 220-8				
25		5SY4 225-8					
32		5SY4 232-8					
40		5SY4 240-8					
50		5SY4 250-8					
63		5SY4 263-8					

For additional components see pages 2/60 and 2/61.
For accessories see pages 2/55 and 2/60.
For dimension drawings see page 2/64.









10 000
3

Miniature Circuit-Breakers (MCBs) Industry Guard Product Range

5SY4 miniature circuit-breakers
10 kA, AC model

2

Selection and ordering data

		I_n	MW	Order No.	Price	Weight 1 item	Pack. unit
		A			1 item	kg	Items
Characteristic D							
	3-pole						
		0.3	3	5SY4 314-8		0.456	4
		0.5		5SY4 305-8			
		1		5SY4 301-8			
		1.6		5SY4 315-8			
		2		5SY4 302-8			
		3		5SY4 303-8			
		4		5SY4 304-8			
		6		5SY4 306-8			
		8		5SY4 308-8			
		10		5SY4 310-8			
		13		5SY4 313-8			
		16		5SY4 316-8			
		20		5SY4 320-8			
	25		5SY4 325-8				
	32		5SY4 332-8				
	40		5SY4 340-8				
	50		5SY4 350-8				
	63		5SY4 363-8				
	3-pole + N						
		0.3	4	5SY4 614-8		0.608	3
		0.5		5SY4 605-8			
		1		5SY4 601-8			
		1.6		5SY4 615-8			
		2		5SY4 602-8			
		3		5SY4 603-8			
		4		5SY4 604-8			
		6		5SY4 606-8			
		8		5SY4 608-8			
		10		5SY4 610-8			
		13		5SY4 613-8			
		16		5SY4 616-8			
		20		5SY4 620-8			
	25		5SY4 625-8				
	32		5SY4 632-8				
	40		5SY4 640-8				
	50		5SY4 650-8				
	63		5SY4 663-8				
	4-pole						
		0.3	4	5SY4 414-8		0.608	3
		0.5		5SY4 405-8			
		1		5SY4 401-8			
		1.6		5SY4 415-8			
		2		5SY4 402-8			
		3		5SY4 403-8			
		4		5SY4 404-8			
		6		5SY4 406-8			
		8		5SY4 408-8			
		10		5SY4 410-8			
		13		5SY4 413-8			
		16		5SY4 416-8			
		20		5SY4 420-8			
	25		5SY4 425-8				
	32		5SY4 432-8				
	40		5SY4 440-8				
	50		5SY4 450-8				
	63		5SY4 463-8				

For additional components see pages 2/60 and 2/61.
For accessories see pages 2/55 and 2/60.
For dimension drawings and terminal connections see page 2/64.

Miniature Circuit-Breakers (MCBs) Industry Guard Product Range



15000
3



5SY7 miniature circuit-breakers 15 kA, AC model







Features

- U_n : 230/400 V, 50-60 Hz applicable in networks up to 250/400 V AC, 60 V DC per pole
- Standards: EN 60 898, DIN VDE 0641 Part 11, IEC 60 898
- 70 mm device mounting depth
- Additional components can be retrofitted.

Application

Characteristic B:
Cable and line protection mainly in socket outlet circuits, proof regarding shock-hazard protection is not necessary.

Selection and ordering data

	I_n	MW	Order No.	Price	Weight 1 item	Pack. unit					
	A			1 item	kg	Items					
Characteristic B											
	1-pole										
		1-pole + N									
			2-pole								
				3-pole							
					3-pole + N						
						4-pole					
						6	1	5SY7 106-6		0.147	12
						10		5SY7 110-6			
13							5SY7 113-6				
16						5SY7 116-6					
20		5SY7 120-6									
25		5SY7 125-6									
32 ¹⁾		5SY7 132-6									
40		5SY7 140-6									
50		5SY7 150-6									
63		5SY7 163-6									
6	2	5SY7 506-6		0.304	6						
10		5SY7 510-6									
13		5SY7 513-6									
16		5SY7 516-6									
20		5SY7 520-6									
25		5SY7 525-6									
32		5SY7 532-6									
40		5SY7 540-6									
50		5SY7 550-6									
63		5SY7 563-6									
6	2	5SY7 206-6		0.304	6						
10		5SY7 210-6									
13		5SY7 213-6									
16		5SY7 216-6									
20		5SY7 220-6									
25		5SY7 225-6									
32		5SY7 232-6									
40		5SY7 240-6									
50		5SY7 250-6									
63		5SY7 263-6									
6	3	5SY7 306-6		0.456	4						
10		5SY7 310-6									
13		5SY7 313-6									
16		5SY7 316-6									
20		5SY7 320-6									
25		5SY7 325-6									
32		5SY7 332-6									
40		5SY7 340-6									
50		5SY7 350-6									
63		5SY7 363-6									
6	4	5SY7 606-6		0.608	3						
10		5SY7 610-6									
13		5SY7 613-6									
16		5SY7 616-6									
20		5SY7 620-6									
25		5SY7 625-6									
32		5SY7 632-6									
40		5SY7 640-6									
50		5SY7 650-6									
63		5SY7 663-6									
6	4	5SY7 406-6		0.608	3						
10		5SY7 410-6									
13		5SY7 413-6									
16		5SY7 416-6									
20		5SY7 420-6									
25		5SY7 425-6									
32		5SY7 432-6									
40		5SY7 440-6									
50		5SY7 450-6									
63		5SY7 463-6									



15000
3

Miniature Circuit-Breakers (MCBs) Industry Guard Product Range







5SY7 miniature circuit-breakers
15 kA, AC model

2

Application

Characteristic C: inrush currents (lamps, motors etc.).
Cable and line protection, especially advantageous with high

Selection and ordering data

	I_n	MW	Order No.	Price	Weight 1 item	Pack. unit
Characteristic C	A			1 item	kg	Items
 <p>1-pole</p> 	0.3	1	5SY7 114-7		0.147	12
	0.5		5SY7 105-7			
	1		5SY7 101-7			
	1.6		5SY7 115-7			
	2		5SY7 102-7			
	3		5SY7 103-7			
	4		5SY7 104-7			
	6		5SY7 106-7			
	8		5SY7 108-7			
	10		5SY7 110-7			
	13		5SY7 113-7			
	16		5SY7 116-7			
	20		5SY7 120-7			
	25		5SY7 125-7			
	32 ¹⁾		5SY7 132-7			
40	5SY7 140-7					
50	5SY7 150-7					
63	5SY7 163-7					
 <p>1-pole + N</p> 	0.3	2	5SY7 514-7		0.304	6
	0.5		5SY7 505-7			
	1		5SY7 501-7			
	1.6		5SY7 515-7			
	2		5SY7 502-7			
	3		5SY7 503-7			
	4		5SY7 504-7			
	6		5SY7 506-7			
	8		5SY7 508-7			
	10		5SY7 510-7			
	13		5SY7 513-7			
	16		5SY7 516-7			
	20		5SY7 520-7			
	25		5SY7 525-7			
	32		5SY7 532-7			
40	5SY7 540-7					
50	5SY7 550-7					
63	5SY7 563-7					
 <p>2-pole</p> 	0.3	2	5SY7 214-7		0.304	6
	0.5		5SY7 205-7			
	1		5SY7 201-7			
	1.6		5SY7 215-7			
	2		5SY7 202-7			
	3		5SY7 203-7			
	4		5SY7 204-7			
	6		5SY7 206-7			
	8		5SY7 208-7			
	10		5SY7 210-7			
	13		5SY7 213-7			
	16		5SY7 216-7			
	20		5SY7 220-7			
	25		5SY7 225-7			
	32		5SY7 232-7			
40	5SY7 240-7					
50	5SY7 250-7					
63	5SY7 263-7					

Cross-references and footnote referring to the pages 2/50 and 2/51:

[For additional components see pages 2/60 and 2/61.](#)

[For accessories see pages 2/55 and 2/60.](#)

[For dimension drawings and terminal connections see page 2/64.](#)

1) Also suitable for 21 kW active power for 3-phase 400 V (e. g. continuous-flow water heater with short time operation) or 7 kW active power with 230 V AC (e. g. storage heater in non-continuous operation). For continuous load conditions, we recommend to use miniature circuit-breakers with characteristic B and C and $I_n = 40$ A.

Miniature Circuit-Breakers (MCBs) Industry Guard Product Range







15000
3

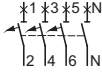

**5SY7 miniature circuit-breakers
15 kA, AC model**

Selection and ordering data

		I_n	MW	Order No.	Price	Weight 1 item	Pack. unit
		A			1 item	kg	Items
Characteristic C							
	3-pole 	0.3	3	5SY7 314-7		0.456	4
		0.5		5SY7 305-7			
		1		5SY7 301-7			
		1.6		5SY7 315-7			
		2		5SY7 302-7			
		3		5SY7 303-7			
		4		5SY7 304-7			
		6		5SY7 306-7			
		8		5SY7 308-7			
		10		5SY7 310-7			
		13		5SY7 313-7			
		16		5SY7 316-7			
		20		5SY7 320-7			
		25		5SY7 325-7			
		32 ¹⁾		5SY7 332-7			
40	5SY7 340-7						
50	5SY7 350-7						
63	5SY7 363-7						
	3-pole + N 	0.3	4	5SY7 614-7		0.608	3
		0.5		5SY7 605-7			
		1		5SY7 601-7			
		1.6		5SY7 615-7			
		2		5SY7 602-7			
		3		5SY7 603-7			
		4		5SY7 604-7			
		6		5SY7 606-7			
		8		5SY7 608-7			
		10		5SY7 610-7			
		13		5SY7 613-7			
		16		5SY7 616-7			
		20		5SY7 620-7			
		25		5SY7 625-7			
		32		5SY7 632-7			
40	5SY7 640-7						
50	5SY7 650-7						
63	5SY7 663-7						
	4-pole 	0.3	4	5SY7 414-7		0.608	3
		0.5		5SY7 405-7			
		1		5SY7 401-7			
		1.6		5SY7 415-7			
		2		5SY7 402-7			
		3		5SY7 403-7			
		4		5SY7 404-7			
		6		5SY7 406-7			
		8		5SY7 408-7			
		10		5SY7 410-7			
		13		5SY7 413-7			
		16		5SY7 416-7			
		20		5SY7 420-7			
		25		5SY7 425-7			
		32		5SY7 432-7			
40	5SY7 440-7						
50	5SY7 450-7						
63	5SY7 463-7						

For additional components see pages 2/60 and 2/61.
 For accessories see pages 2/55 and 2/60.
 For dimension drawings and terminal connections see page 2/64.

1) Also suitable for 21 kW active power for 3-phase 400 V (e. g. continuous-flow water heater with short time operation) or 7 kW active power with 230 V AC (e. g. storage heater in non-continuous operation). For continuous load conditions, we recommend to use miniature circuit-breakers with characteristic B and C and $I_n = 40$ A.



15000
3

Miniature Circuit-Breakers (MCBs) Industry Guard Product Range







5SY7 miniature circuit-breakers
15 kA, AC model

2

Application

Characteristic D:
The tripping range has been matched to applications involving equipment generating significant pulses (transformers, solenoid valves).

Selection and ordering data

	I_n	MW	Order No.	Price	Weight 1 item	Pack. unit	
	A			1 item	kg	Items	
Characteristic D							
	1-pole						
		0.3	1	5SY7 114-8		0.147	12
		0.5		5SY7 105-8			
		1		5SY7 101-8			
		1.6		5SY7 115-8			
		2		5SY7 102-8			
		3		5SY7 103-8			
		4		5SY7 104-8			
		6		5SY7 106-8			
		8		5SY7 108-8			
		10		5SY7 110-8			
		13		5SY7 113-8			
		16		5SY7 116-8			
20		5SY7 120-8					
25	5SY7 125-8						
32	5SY7 132-8						
40	5SY7 140-8						
50	5SY7 150-8						
63	5SY7 163-8						
	1-pole + N						
		0.3	2	5SY7 514-8		0.304	6
		0.5		5SY7 505-8			
		1		5SY7 501-8			
		1.6		5SY7 515-8			
		2		5SY7 502-8			
		3		5SY7 503-8			
		4		5SY7 504-8			
		6		5SY7 506-8			
		8		5SY7 508-8			
		10		5SY7 510-8			
		13		5SY7 513-8			
		16		5SY7 516-8			
20		5SY7 520-8					
25	5SY7 525-8						
32	5SY7 532-8						
40	5SY7 540-8						
50	5SY7 550-8						
63	5SY7 563-8						
	2-pole						
		0.3	2	5SY7 214-8		0.304	6
		0.5		5SY7 205-8			
		1		5SY7 201-8			
		1.6		5SY7 215-8			
		2		5SY7 202-8			
		3		5SY7 203-8			
		4		5SY7 204-8			
		6		5SY7 206-8			
		8		5SY7 208-8			
		10		5SY7 210-8			
		13		5SY7 213-8			
		16		5SY7 216-8			
20		5SY7 220-8					
25	5SY7 225-8						
32	5SY7 232-8						
40	5SY7 240-8						
50	5SY7 250-8						
63	5SY7 263-8						

For additional components see pages 2/60 and 2/61.
For accessories see pages 2/55 and 2/60.
For dimension drawings and terminal connections see page 2/64.

Miniature Circuit-Breakers (MCBs) Industry Guard Product Range







15000
3

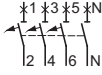

**5SY7 miniature circuit-breakers
15 kA, AC model**

Selection and ordering data

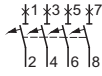
		I_n	MW	Order No.	Price	Weight 1 item	Pack. unit
		A			1 item	kg	Items
Characteristic D							
	3-pole 	0.3	3	5SY7 314-8		0.456	4
		0.5		5SY7 305-8			
		1		5SY7 301-8			
		1.6		5SY7 315-8			
		2		5SY7 302-8			
		3		5SY7 303-8			
		4		5SY7 304-8			
		6		5SY7 306-8			
		8		5SY7 308-8			
		10		5SY7 310-8			
		13		5SY7 313-8			
		16		5SY7 316-8			
		20		5SY7 320-8			
		25		5SY7 325-8			
		32		5SY7 332-8			
40	5SY7 340-8						
50	5SY7 350-8						
63	5SY7 363-8						
	3-pole + N 	0.3	4	5SY7 614-8		0.608	3
		0.5		5SY7 605-8			
		1		5SY7 601-8			
		1.6		5SY7 615-8			
		2		5SY7 602-8			
		3		5SY7 603-8			
		4		5SY7 604-8			
		6		5SY7 606-8			
		8		5SY7 608-8			
		10		5SY7 610-8			
		13		5SY7 613-8			
		16		5SY7 616-8			
		20		5SY7 620-8			
		25		5SY7 625-8			
		32		5SY7 632-8			
40	5SY7 640-8						
50	5SY7 650-8						
63	5SY7 663-8						
	4-pole 	0.3	4	5SY7 414-8		0.608	3
		0.5		5SY7 405-8			
		1		5SY7 401-8			
		1.6		5SY7 415-8			
		2		5SY7 402-8			
		3		5SY7 403-8			
		4		5SY7 404-8			
		6		5SY7 406-8			
		8		5SY7 408-8			
		10		5SY7 410-8			
		13		5SY7 413-8			
		16		5SY7 416-8			
		20		5SY7 420-8			
		25		5SY7 425-8			
		32		5SY7 432-8			
40	5SY7 440-8						
50	5SY7 450-8						
63	5SY7 463-8						

For additional components see pages 2/60 and 2/61.
 For accessories see pages 2/55 and 2/60.
 For dimension drawings and terminal connections see page 2/64.

Miniature Circuit-Breakers (MCBs) Industry Guard Product Range

Accessories for 5SY4, 5SY7
miniature circuit-breakers

2

Busbar system

Features

- According to DIN 57 606 and DIN 57 659
- Load when feeding at one end/center 65 A/120 A for 16 mm².

- Single- and multi-phase
- Cu 16 mm² fully insulated
- 18 mm lug spacing
- With connection up to 35 mm² stranded, no additional terminal required

- Very good access to the feeder cable.



	Length	Order No.	Price	Weight	Pack. unit
	mm			kg	Items
Fully insulated					
			1 item	1 item	
1-phase	214	5ST3 700		0.040	50
1-phase + AS		5ST3 702			
2-phase		5ST3 704		0.060	25
2-phase + AS		5ST3 706			
3-phase		5ST3 708		0.100	25
3-phase + AS		5ST3 711			
3 × (1-phase + AS)		5ST3 713			
4-phase		5ST3 715		0.150	20
Without end caps					
1-phase	1016	5ST3 701		0.190	50
1-phase + AS		5ST3 703			
2-phase		5ST3 705		0.290	20
2-phase + AS		5ST3 707			
3-phase		5ST3 710		0.430	20
3-phase + AS		5ST3 712			
3 × (1-phase + AS)		5ST3 714			
4-phase		5ST3 716		0.700	15
End caps to be mounted laterally for insulation of cut-to-length busbars					
			100 items	100 items	
2- and 3-phase		5SH5 514		0.1	10
			1 item	1 item	
4-phase		5ST3 718		0.001	

Miniature Circuit-Breakers (MCBs) High-Current Product Range



10 000

5SP4 miniature circuit-breakers 10 kA, AC model

Features

- U_n : 230/400 V, 50-60 Hz applicable in networks up to 250/440 V AC, 60 V DC per pole
- Standards: IEC 60 898, EN 60 898, EN 60 204, DIN VDE 0641 Part 11
- 70 mm device mounting depth
- Additional components can be retrofitted.









Application

- As main switch and miniature circuit-breaker in functional buildings and industry
- Characteristic B: Cable and line protection mainly in socket outlet circuits, proof regarding shock-hazard protection is not required.

Advantages

- Main switch characteristics according to EN 60 204
- Can be snapped onto standard mounting rails acc. to DIN EN 50 022.
- Can be screwed onto base.

Selection and ordering data

	I_n	MW	Order No.	Price	Weight 1 item	Pack. unit
	A			1 item	kg	Items
Characteristic B						
	1-pole			5SP4 180-6 5SP4 191-6 5SP4 192-6	0.260	6
	80	1.5				
	100					
	2-pole			5SP4 280-6 5SP4 291-6 5SP4 292-6	0.516	3
	80	3				
	100					
	3-pole			5SP4 380-6 5SP4 391-6 5SP4 392-6	0.760	2
	80	4.5				
	100					
	4-pole			5SP4 480-6 5SP4 491-6 5SP4 492-6	1.000	1
	80	6				
	100					
	125					

For additional components see pages 2/60 and 2/61.

For accessories see page 2/60.

For dimension drawings and terminal connections see page 2/64.



10 000

Miniature Circuit-Breakers (MCBs) High-Current Product Range





5SP4 miniature circuit-breakers
10 kA, AC model

2

Application

Characteristic C:
General cable and line protection,
especially advantageous
with high inrush currents
(lamps, motors etc.).

Selection and ordering data

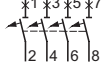
	I_n	MW	Order No.	Price	Weight 1 item	Pack. unit	
	A			1 item	kg	Items	
Characteristic C							
	1-pole		5SP4 180-7 5SP4 191-7 5SP4 192-7		0.260	6	
		80 100 125					1.5
	2-pole						5SP4 280-7 5SP4 291-7 5SP4 292-7
	80 100 125	3					
3-pole		5SP4 380-7 5SP4 391-7 5SP4 392-7		0.760	2		
	80 100 125					4.5	
4-pole						5SP4 480-7 5SP4 491-7 5SP4 492-7	
	80 100 125	6					

For additional components see pages 2/60 and 2/61.

For accessories see page 2/60.

For dimension drawings and terminal connections see page 2/64.

Miniature Circuit-Breakers (MCBs) High-Current Product Range









10 000

5SP4 miniature circuit-breakers 10 kA, AC model

Application

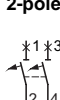
Characteristic D:
The tripping range has been matched to applications involving equipment generating significant pulses (transformers, solenoid valves).

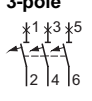
Selection and ordering data

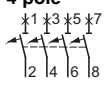
	I_n	MW	Order No.	Price	Weight 1 item	Pack. unit
Characteristic D	A			1 item	kg	Items
 <p>1-pole</p> 	80	1.5	5SP4 180-8 5SP4 191-8		0.260	6
	100					
 <p>2-pole</p> 	80	3	5SP4 280-8 5SP4 291-8		0.510	3
	100					
 <p>3-pole</p> 	80	4.5	5SP4 380-8 5SP4 391-8		0.760	2
	100					
 <p>4-pole</p> 	80	6	5SP4 480-8 5SP4 491-8		1.000	1
	100					

For additional components see pages 2/60 and 2/61.

For accessories see page 2/60.

For dimension drawings and terminal connections see page 2/64.

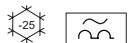

Miniature Circuit-Breakers (MCBs) Industry Guard/High Current Product Range

Additional components for 5SY4, 5SY7, 5SP4 miniature circuit-breakers

2

Features

- Standards: EN 61 009-1, EN 61 009-2-1, IEC 61 009-1 and IEC 61 009-2-1
- In combination with miniature circuit-breakers with characteristic B and C, can be retrofitted
- Rated voltage: 2-pole 125 V AC up to 230 V, 50 Hz up to 60 Hz
4-pole 230 V AC up to 400 V, 50 Hz up to 60 Hz
- Applicable in networks: 2-pole 230 V AC, 125/240 V AC
4-pole 220/380 V AC, 230/400 V AC, 240/415 V AC.

Selection and ordering data

	$I_{\Delta n}$ mA	I_n A	MW	Order No.	Price 1 item	Weight 1 item kg	Pack. unit Items
RCCB module for 5SY4, 5SY7 miniature circuit-breakers for AC and pulsating DC fault currents							
	2-pole						
		30	6/40	2	5SM2 322-6	0.245	1
		300	6/40	2	5SM2 622-6	0.350	1
		30	6/63		5SM2 325-6		
	300	6/63		5SM2 625-6			
	2-pole, for selective disconnection S						
	300	6/40	2	5SM2 622-8	0.350	1	
		6/63		5SM2 625-8			
	4-pole						
		30	6/40	3	5SM2 342-6	0.365	1
		300	6/40	3	5SM2 642-6	0.400	1
		30	6/63		5SM2 345-6		
	300	6/63		5SM2 645-6			
	4-pole, for selective disconnection S						
	300	6/40	3	5SM2 645-8	0.400	1	
	1,000	6/63		5SM2 845-8			
RCCB module for 5SP4 miniature circuit-breakers for AC and pulsating DC fault currents							
	2-pole						
		30	80/100	3.5	5SM2 327-6	0.550	1
		300	80/100	3.5	5SM2 627-6		
	2-pole, for selective disconnection S						
	300	80/100	3.5	5SM2 627-8	0.550	1	
	4-pole						
		30	80/100	5	5SM2 347-6	0.944	1
		300	80/100	5	5SM2 647-6		
	4-pole, for selective disconnection S						
	300	80/100	5	5SM2 647-8	0.950	1	
	1,000	80/100	5	5SM2 847-8			

For dimension drawings and terminal connections see page 2/64.

Miniature Circuit-Breakers (MCBs) Industry Guard/High-Current Product Range

Additional components for 5SY4/5SY7/5SP4 miniature circuit-breakers

- Features**
- Can be retrofitted
 - Mounting with factory-installed clips
 - Short-circuit protection due to miniature circuit-breakers with characteristic B or C and $I_n = 6\text{ A}$ or fuse gL 6 A

Application

Remote display of the switching status of the miniature circuit-breaker

- AS: ON/OFF
- FC: tripped.

- Auxiliary switches (AS) and fault signal contacts (FC)**
- Max. contact load:
NO contact:
2 A, 400 V AC, AC-14
6 A, 230 V AC, AC-13
1 A, 220 V DC, DC-13
1 A, 110 V DC, DC-13
3 A, 60 V DC, DC-13
6 A, 24 V DC, DC-13
NC contact:
2 A, 400 V AC, AC-13
6 A, 230 V AC, AC-13
1 A, 220 V DC, DC-13
1 A, 110 V DC, DC-13
3 A, 60 V DC, DC-13
6 A, 24 V DC, DC-13
 - Can be connected to *instabus EIB* and AS-Interface bus.

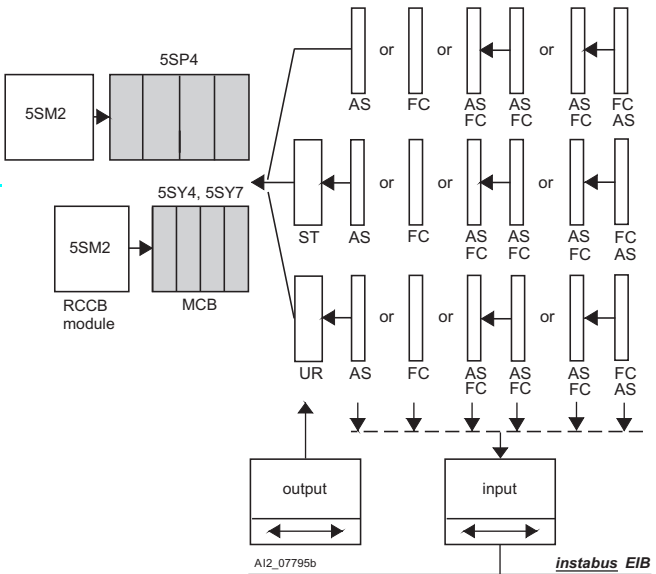

Selection and ordering data

MW	Order No.	Price	Weight 1 item	Pack. unit
		1 item	kg	Items

Auxiliary switches (AS) and fault signal contacts (FC)



Auxiliary switches (AS)

	1 NO + 1 NC	0.5
	2 NO	
	2 NC	

5ST3 010	0.050	1
5ST3 011		
5ST3 012		



Fault signal contacts (FC)

	1 NO + 1 NC	0.5
	2 NO	
	2 NC	

5ST3 020	0.050	1
5ST3 021		
5ST3 022		

For dimension drawings and terminal connections see page 2/64.

Miniature Circuit-Breakers (MCBs) Industry Guard/High-Current Product Range

Additional components for 5SY4/5SY7/5SP4
miniature circuit-breakers

2

Shunt trips

Features

- Operating limit acc. to DIN VDE 0660 Part 100, 7.2.1.4

- For voltages: 110 up to 415 V AC, 110 V DC, 24 up to 48 V DC

- Can be connected via binary outputs to *instabus* EIB and AS-Interface bus.

Application

Remote-controlled tripping of the MCB.

Undervoltage release

Features

- Operating limits acc. to DIN VDE 0660 Part 100, 7.2.1.3





- For voltages: 230 V AC, 110 V DC, 24 V AC
- Can be connected via binary outputs to *instabus* EIB und AS-Interface bus.

Application

- Can be used as remote release in an EMERGENCY STOP circuit
- Ensures disconnection of the control circuit acc. to EN 60 204

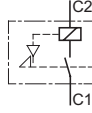
- In the event of an interrupted voltage or undervoltage, the undervoltage release trips the miniature circuit-breaker or prevents it from being switched on.

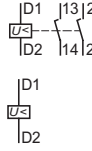
Selection and ordering data

		MW	Order No.	Price 1 item	Weight 1 item kg	Pack. unit Items
Shunt trip (ST)						
		110-415 V AC	1	5ST3 030	0.090	1
		24-48 V DC	1			
Undervoltage release (UR)						
		230 V AC	1	5ST3 040 5ST3 041 5ST3 042	0.115	1
		110 V DC				
24 V DC						
		230 V AC	1	5ST3 043 5ST3 044 5ST3 045		
		110 V DC				
		24 V DC				

For dimension drawings and terminal connections see page 2/64.

Miniature Circuit-Breakers (MCBs) Industry Guard/High-Current Product Range

Accessories for 5SY4/5SY7/5SP4
miniature circuit-breakers

Selection and ordering data



	Order No.	Price	Weight 1 item kg	Pack. unit Items
Handle locking device for all types of poles sealable to prevent unauthorized mechanical closing and opening, padlock with max. 3 mm shackle	5ST3 801	1 item	0.007	1
Terminal cover for all types of poles as an additional cover of screw openings also prevents the removal of the device from the standard mounting rail, sealable	5ST3 800		0.001	10
Padlock NEW for handle locking device 5ST3 801	5ST3 802		0.020	1
Locking mechanism NEW consisting of 5ST3 801 handle locking device and 5ST3 802 padlock	5ST3 803	1 set	1 set 0.027	1 set
Labeling system NEW Features <ul style="list-style-type: none"> • self-adhesive labels • inscription is possible <ul style="list-style-type: none"> - by hand with non-smearing waterproof markers - using computer-controlled labeling systems. Advantages <ul style="list-style-type: none"> • Time and cost saving • Standard size with legible inscription • All types of inscriptions are possible • Simple data entry and program handling via interactive dialogs • The labeling program can be downloaded free of charge at www.industry-guards.de. 				

Miniature Circuit-Breakers (MCBs)

Power Supply Comp., Standard, AC/DC, Industry Guard/High-Current Product Range

Accessories

2

Inscription labels

Features

- Self-adhesive
- Inscription is possible
 - by hand with non-smearing, waterproof markers
 - using computer-controlled labeling systems.

Advantages

- Time and cost saving
- Standard size with legible inscription
- All types of inscriptions are possible including special characters

- Simple data entry and program handling via interactive dialogs

Information can be obtained from:

Murrplastik-Systemtechnik GmbH
Fabrikstrasse 10
D-71570 Oppenweiler
Germany

Selection and ordering data

Order No.	Price	Weight 1 item	Pack. unit
	1 set	kg	set

Inscription labels (white)



15 x 9 mm, 3 frames with 44 labels each, to be stuck onto the lower housing collar

5ST2 173		0.038	1
-----------------	--	-------	---



Screw-in design acc. to DIN 49 500, 6 kA

Features

- U_n : 230/400 V AC, 50 - 60 Hz; 250 V DC
- I_n : 6 to 25 A
- I_{cn} : 6 000 A.

Application

Applicable in fuse bases with size DII/E 27.

Design

Operation with pushbuttons.

Selection and ordering data

I_n	Order No.	Price	Weight 1 item	Pack. unit
A		1 item	kg	Items

Characteristic L



1-pole

6
10
16
20
25

5SJ2 062		0.120	10
5SJ2 102			
5SJ2 162		0.130	
5SJ2 202			
5SJ2 252			

According to the valid VDE standard 0641 Part 3/04.84, screw-in MCBs may also be used with characteristic L in the future.

Planning Aid

Dimensions

5SX N-type miniature circuit-breaker

5SX2, 5SX4, 5SX5

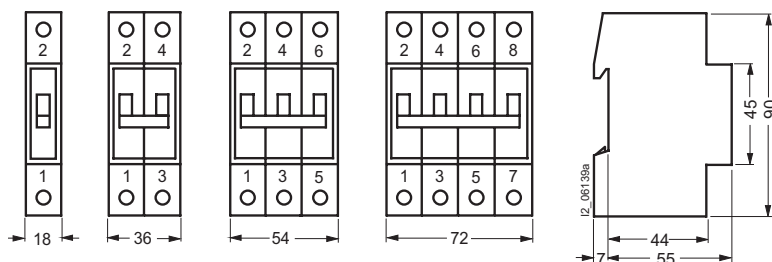

5SQ Miniature circuit-breaker

5SQ3 5..

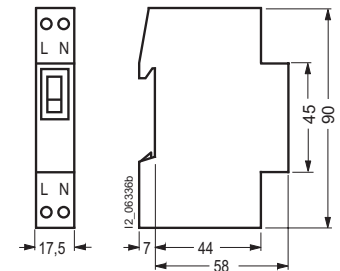

Miniature Circuit-Breakers (MCBs) Planning Aid

Dimensions

5SX9 auxiliary switch, 5SX9 fault signal contact

Additional component for 5SX2, 5SX4, 5SX5; can be retrofitted to 5SX9 1..., 5SX9 2..

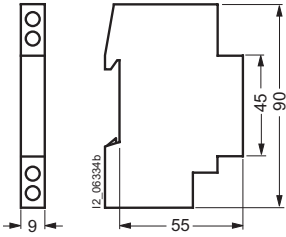

5SP3 7 main miniature circuit-breaker device mounting depth 91 mm

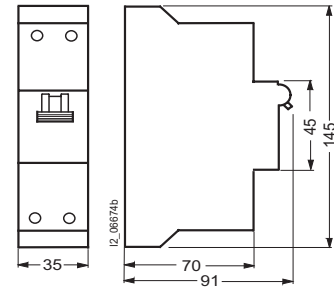

5SY4, 5SY7 miniature circuit-breakers

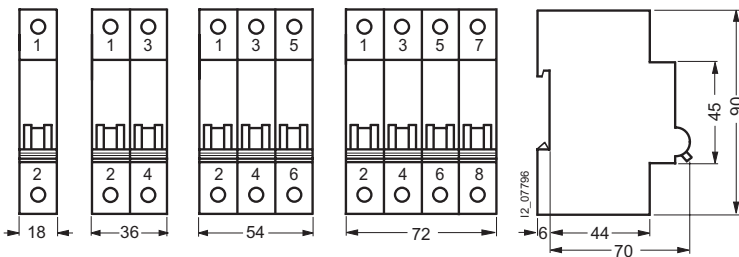

5ST3 auxiliary switch 5ST3 fault signal contact can be retrofitted to 5SP4, 5SY4, 5SY7

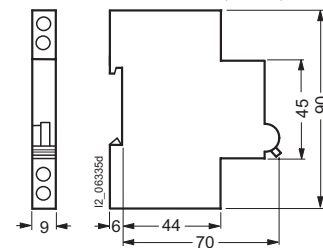

5SP4 miniature circuit-breaker

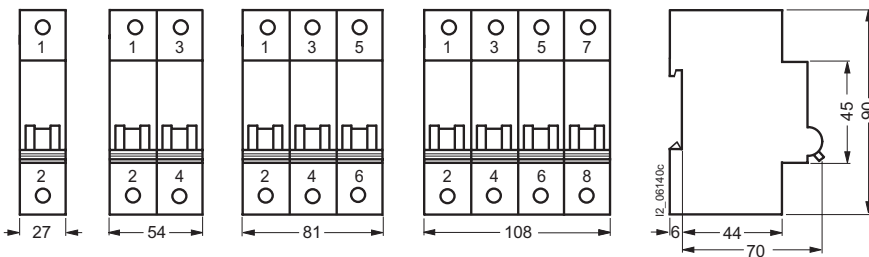

5ST3 shunt trip 5ST3 undervoltage release can be retrofitted to 5SP4, 5SY4, 5SY7

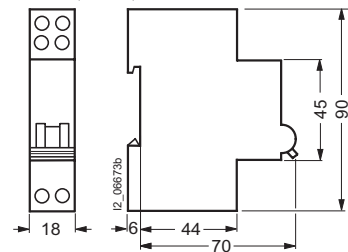

5SM2 RCCB module

Additional component for 5SY..

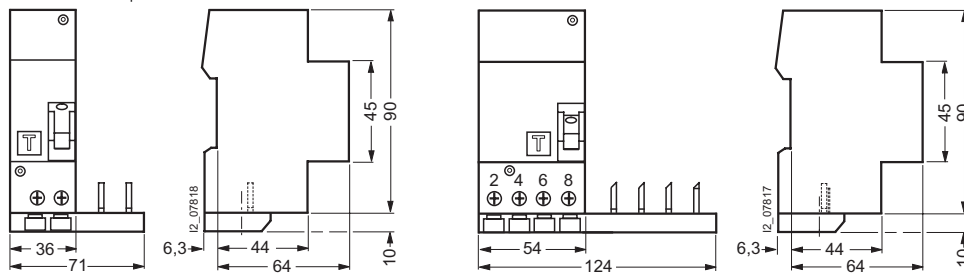

5SM2 RCCB module

Additional component for 5SP4

