

# ZM Series Mini Size Snap-acting Switches

## Features/Benefits

- **Reliable snap-acting mechanism**
- **Long electrical and mechanical life**
- **Compact size—Ideal when space is limited**
- **Various PCB terminals and actuators**
- **RoHS compliant / compatible**

## Typical Applications

- **PCB detection switch**
- **Communication devices**
- **Testing equipment**
- **Security/Alarm systems**
- **Consumer electronics**
- **Automotive: door latch, seat position detection, EV charging**

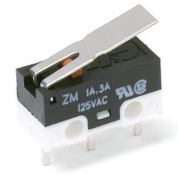

UL61058-1  

## Specifications

CONTACT RATING: F7: 3A @ 125 VAC  
M9: 0.2A @ 60 VDC.  
ELECTRICAL LIFE: 10,000 Cycles. @ 3A  
INSULATION RESISTANCE: 100 M ohm min.  
DIELECTRIC STRENGTH: 1000 Vrms.  
OPERATING TEMPERATURE: -30°C to 85°C.  
OPERATING FORCE: CJ: 150 grams, CH: 90 grams.

\* Low Level=conditions where no arcing occurs during switching, i.e., 0.4 VA max. @ 20 V AC or DC max.

## Materials



COVER: Nylon 6/6  
ACTUATOR BUTTON: Nylon 6/6  
CASE: Nylon 6/6  
SPRING: SUS  
MOVABLE BLADE: BeCu  
MOVABLE CONTACT: Silver alloy (M9 option gold plated)  
FIXED CONTACTS: Silver alloy (M9 option gold plated)  
FIXED TERMINALS: Brass - Ag plated.  
ACTUATOR (Leaf / Roller options): SUS

**NOTE:** Specifications and materials listed above are for switches with standard options. For information on specific and custom switches, consult Customer Service Center.

## Build-A-Switch

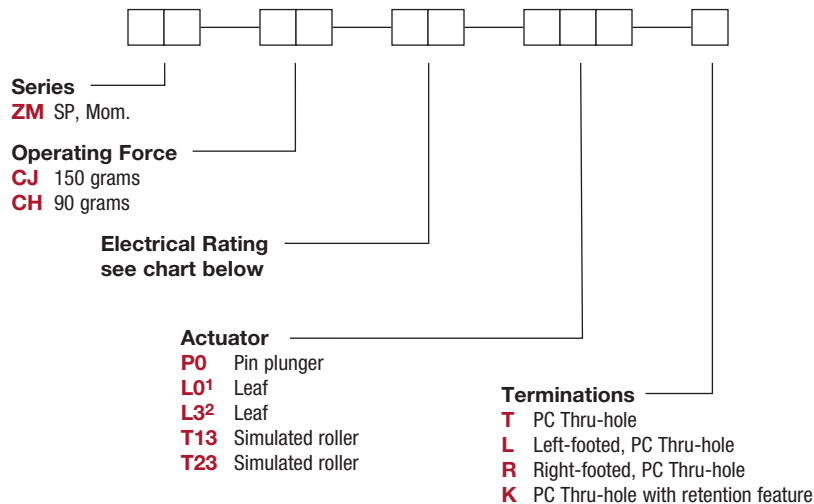
To order, simply select desired option from each category and place in the appropriate box. For additional options not shown in catalog, consult Customer Service Center.



Option Code	 1054	 61058-1	
<b>F7</b>	3 A 125 V AC	3 A 125 V AC 3 A 30 V DC	3 A 125 V AC
<b>M9</b>	0.1 A 48 V DC 0.2 A 60 V DC 0.1 A 125 V AC	0.1 A 48 V DC 0.2 A 60 V DC 0.1 A 125 V AC	0.1 A 48 V DC 0.2 A 60 V DC 0.1 A 125 V AC

Available in Operating Force-Actuator combination:  
CJ-L01  
CH-L32

# ZM Series Mini Size Snap-acting Switches

## SERIES

**ZM** MINI SIZE SNAP-ACTING SWITCHES – SP MOMENTARY

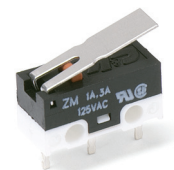
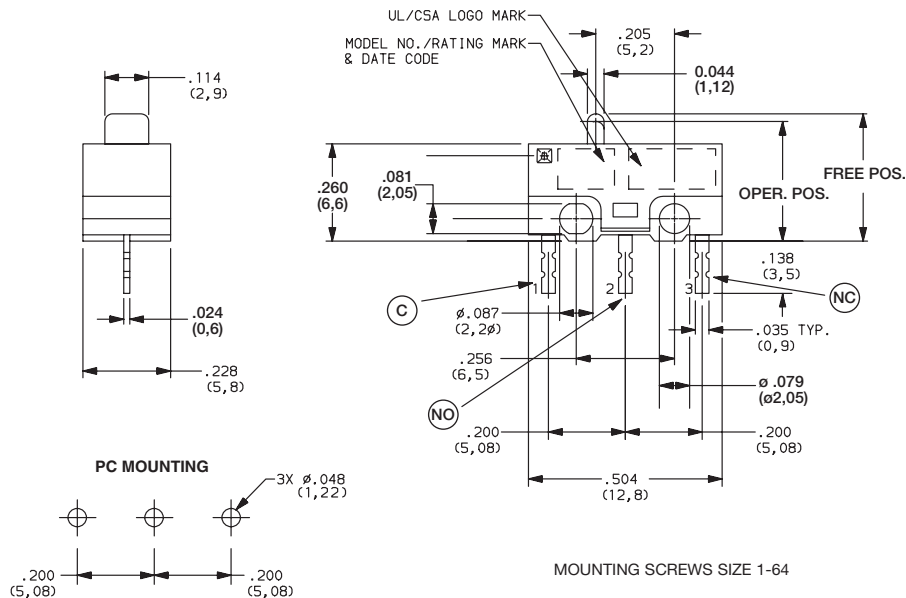

ZMCJF7L0T  
SPDT

Snap-acting

## OPERATING FORCE

OPTION CODE	BASIC SWITCH OPERATING FORCE (OZ./GRAMS)
<b>CJ</b>	5.29 150
<b>CH</b>	3.15 90

## ELECTRICAL RATING

OPTION CODE	RoHS COMPLIANT*	RoHS COMPATIBLE*	CONTACT MATERIAL		ELECTRICAL RATING
			MOVABLE CONTACT	STATIONARY CONTACT	
<b>F7</b>	Yes	Yes	Silver alloy		see chart
<b>M9</b>	Yes	Yes	Gold plating or silver alloy		see chart

\* Note: See Technical Data section of this catalog for RoHS compliant and compatible definition and specifications.

All models with all options.

Consult Customer Service center for availability and delivery of nonstandard ratings.

Option Code	US 1054	US 61058-1	4
<b>F7</b>	3 A 125 V AC	3 A 125 V AC 3 A 30 V DC	3 A 125 V AC
<b>M9</b>	0.1 A 48 V DC 0.2 A 60 V DC 0.1 A 125 V AC	0.1 A 48 V DC 0.2 A 60 V DC 0.1 A 125 V AC	0.1 A 48 V DC 0.2 A 60 V DC 0.1 A 125 V AC



Third Angle Projection

Dimensions are shown: Inch (mm)  
Specifications and dimensions subject to change



# ZM Series Mini Size Snap-acting Switches

## ACTUATOR

**P0** PIN PLUNGER

**L0** LEAF, 50 GRAMS (CJ ONLY)  
**L3** LEAF, 30 GRAMS (CH ONLY)

**T13** SIMULATED ROLLER, 40 GRAMS (CJ ONLY)  
**T23** SIMULATED ROLLER, 25 GRAMS (CH ONLY)

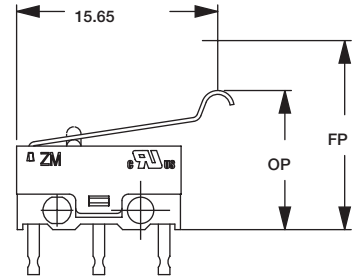
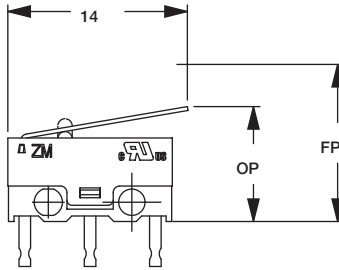
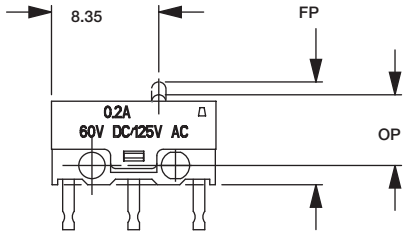

ACTUATOR OPTION CODE	A (mm)	B Ref (mm)	C (mm)	D (mm)	E (mm)	DIFF. MOTION mm MAX	OPER. FORCE grams MAX		RELEASED FORCE Grams MAX	OVER TRAVEL MIN
	LENGTH OF LEVER	LEVER LENGTH MTG. HOLE TO OP	PRE- TRAVEL MAX	OPERATING POSITION	FREE POSITION MAX		CJ	CH		
P0 PIN PLUNGER	NA	NA	1.3	7.0 ±0.3	8.0	0.3	150	90	15-20	0.2
L0 LEAF	13.0	4.03	3.4	8.4 ±0.8	11.0	1.3	50	-	8	0.6
L3 LEAF	13.0	4.03	3.4	8.4 ±0.8	11.0	1.3	-	30	5	0.6
T13 SIMULATED ROLLER	15.0	5.36	3.8	10.5 ±0.8	13.0	1.5	40	-	7	0.6
T23 SIMULATED ROLLER	15.0	5.36	3.8	10.5 ±0.8	13.0	1.5	-	25	4	0.6

## TERMINATIONS

**T** (STD.) PC THRU-HOLE

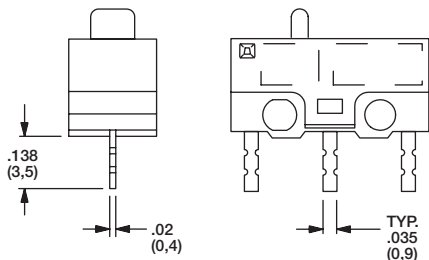

**K** PC THRU-HOLE WITH RETENTION FEATURE

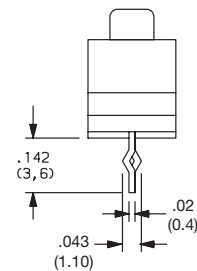

**L** LEFT FOOTED, PC THRU-HOLE

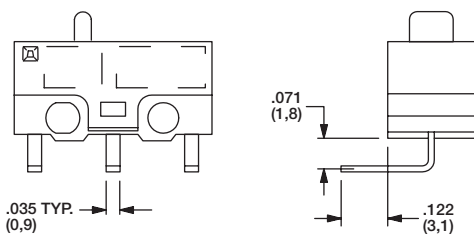

**R** RIGHT FOOTED, PC THRU-HOLE

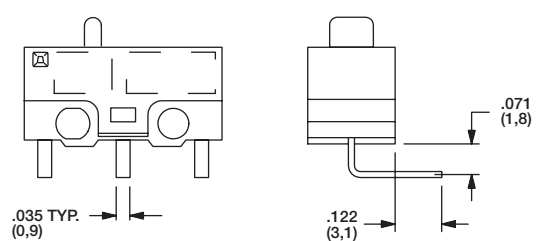

Third Angle  
Projection

Dimensions are shown: Inches (mm)  
Specifications and dimensions subject to change