

D10SC6MR Forward Voltage

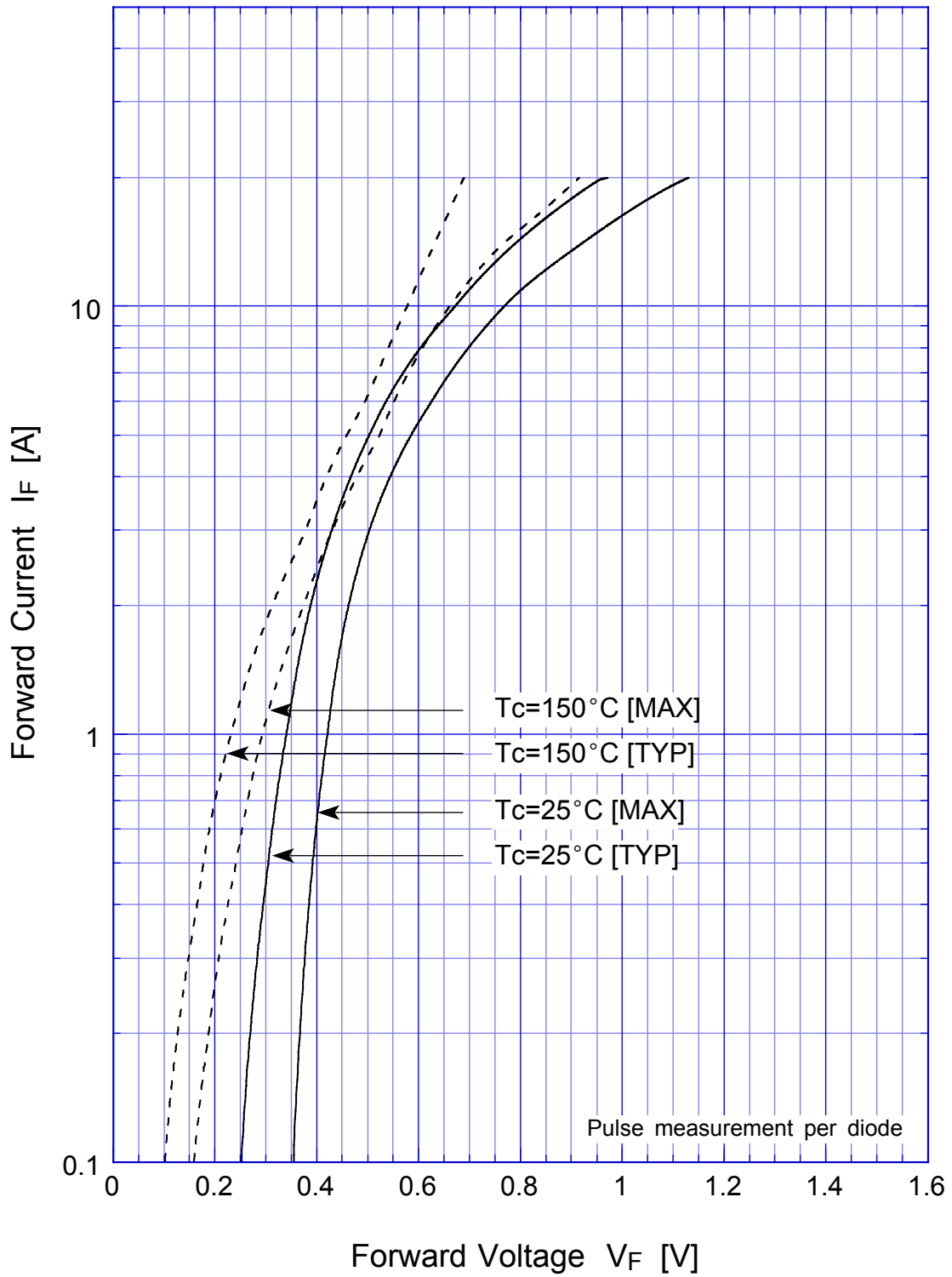

D10SC6MR Junction Capacitance

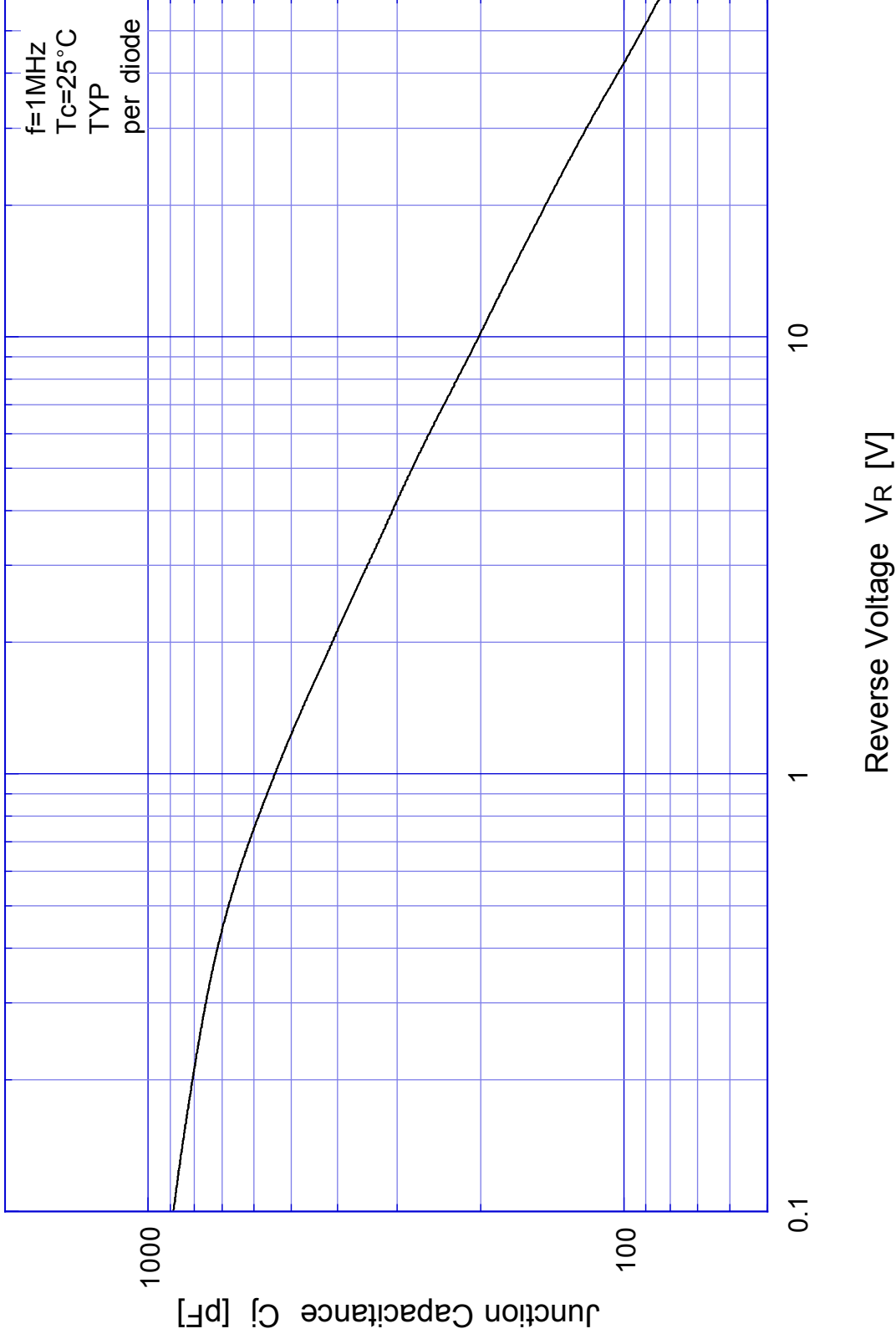

D10SC6MR Reverse Current

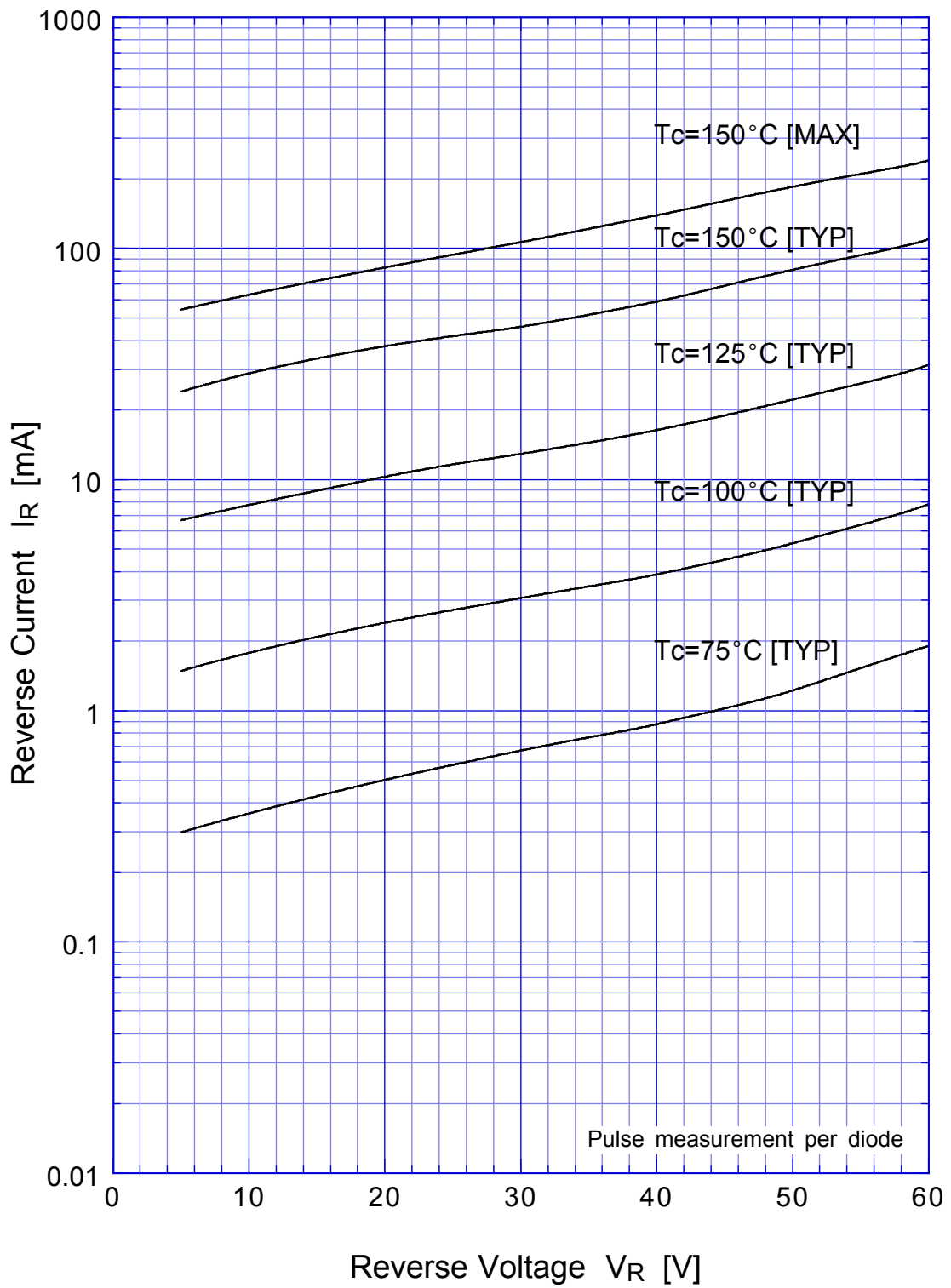

D10SC6MR Reverse Power Dissipation

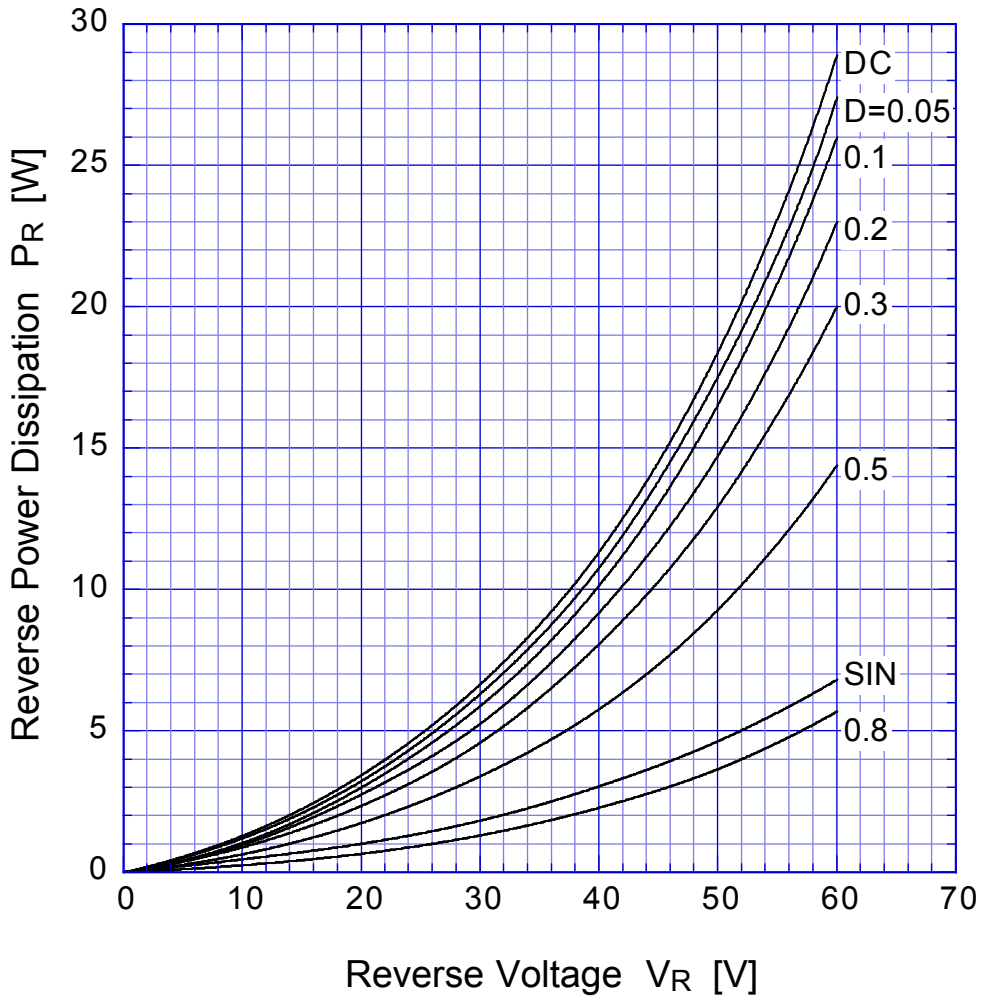

$T_j = 150^\circ\text{C}$

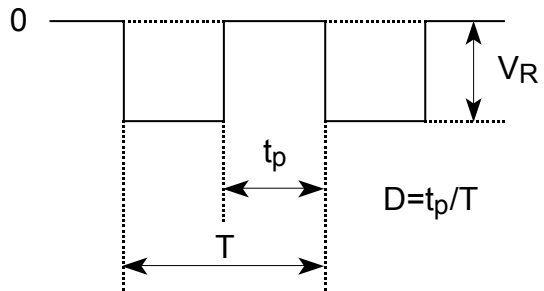

D10SC6MR Forward Power Dissipation

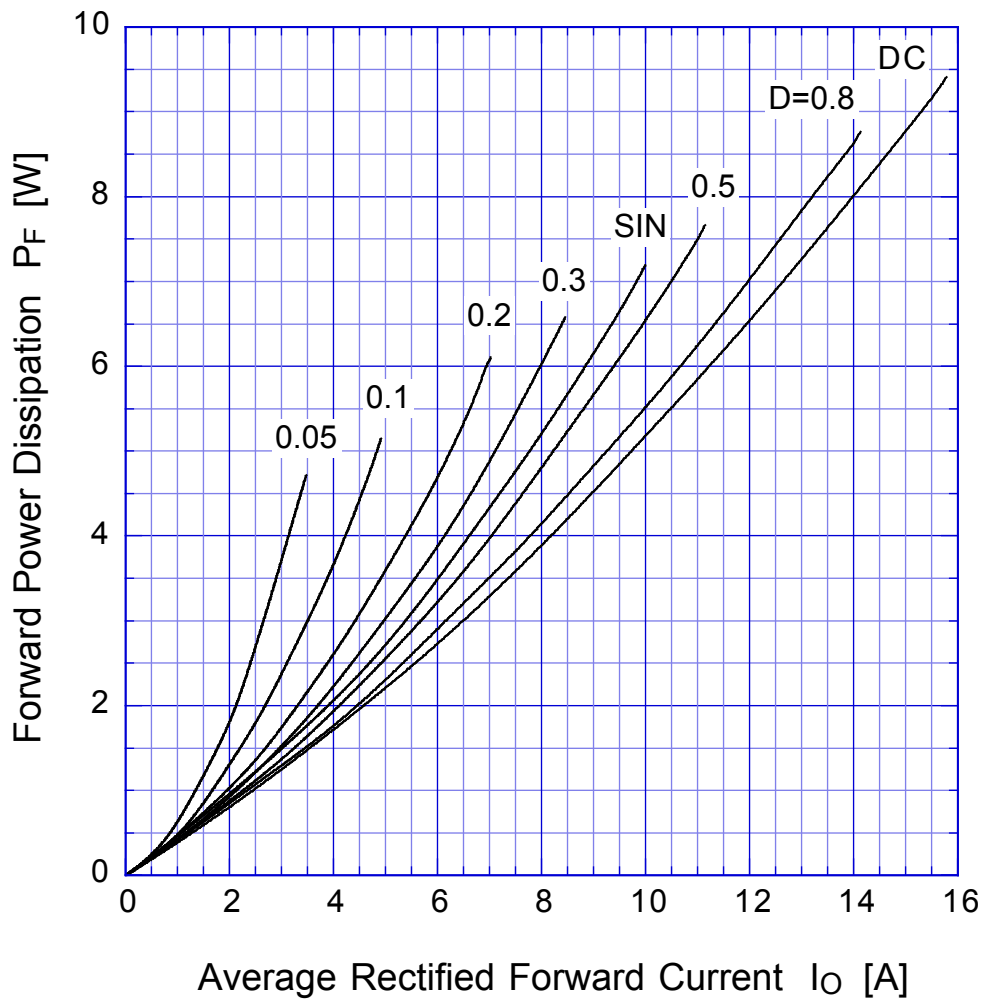

$T_j = 150^\circ\text{C}$

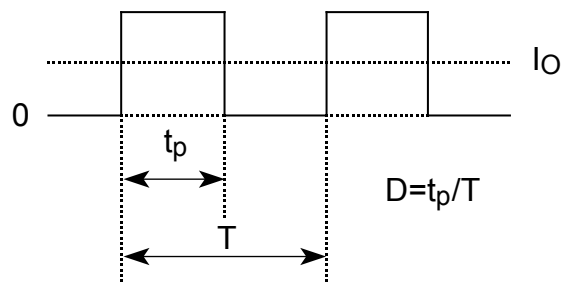

D10SC6MR

Derating Curve

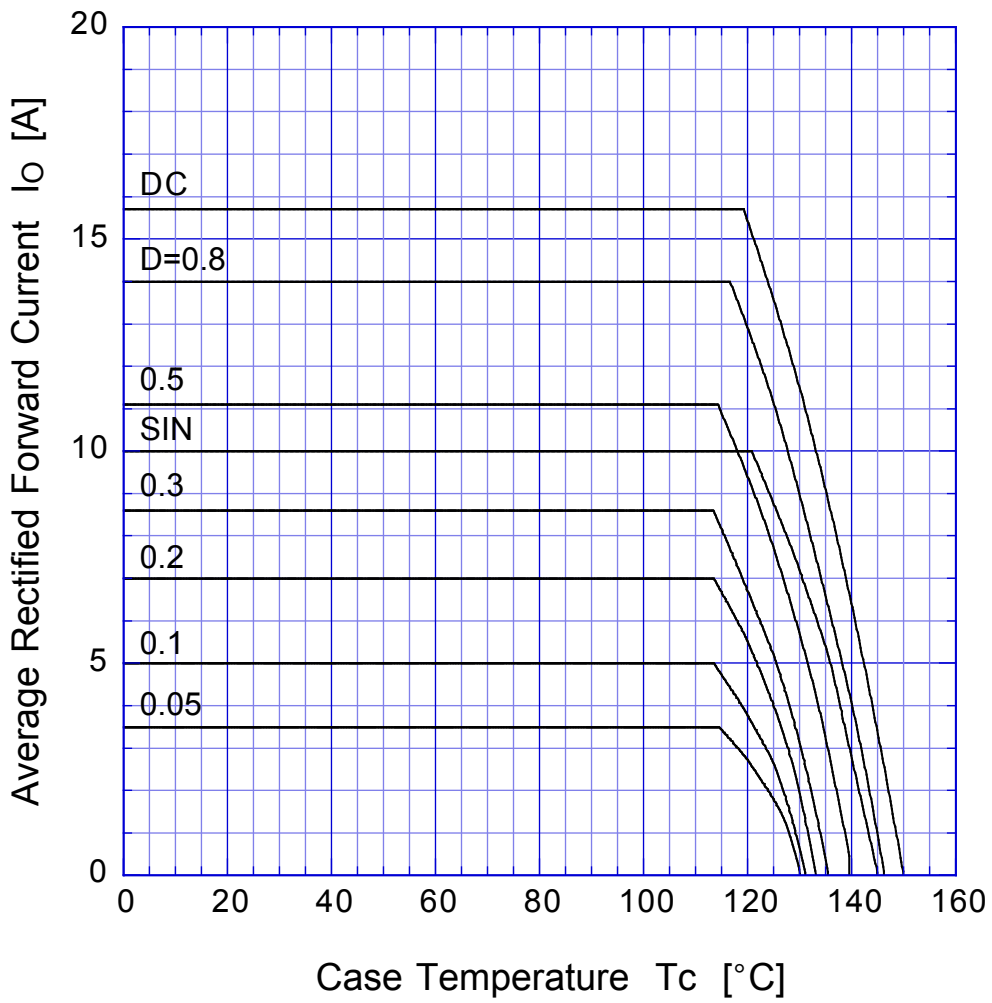

$V_R = 30V$



D10SC6MR

Derating Curve

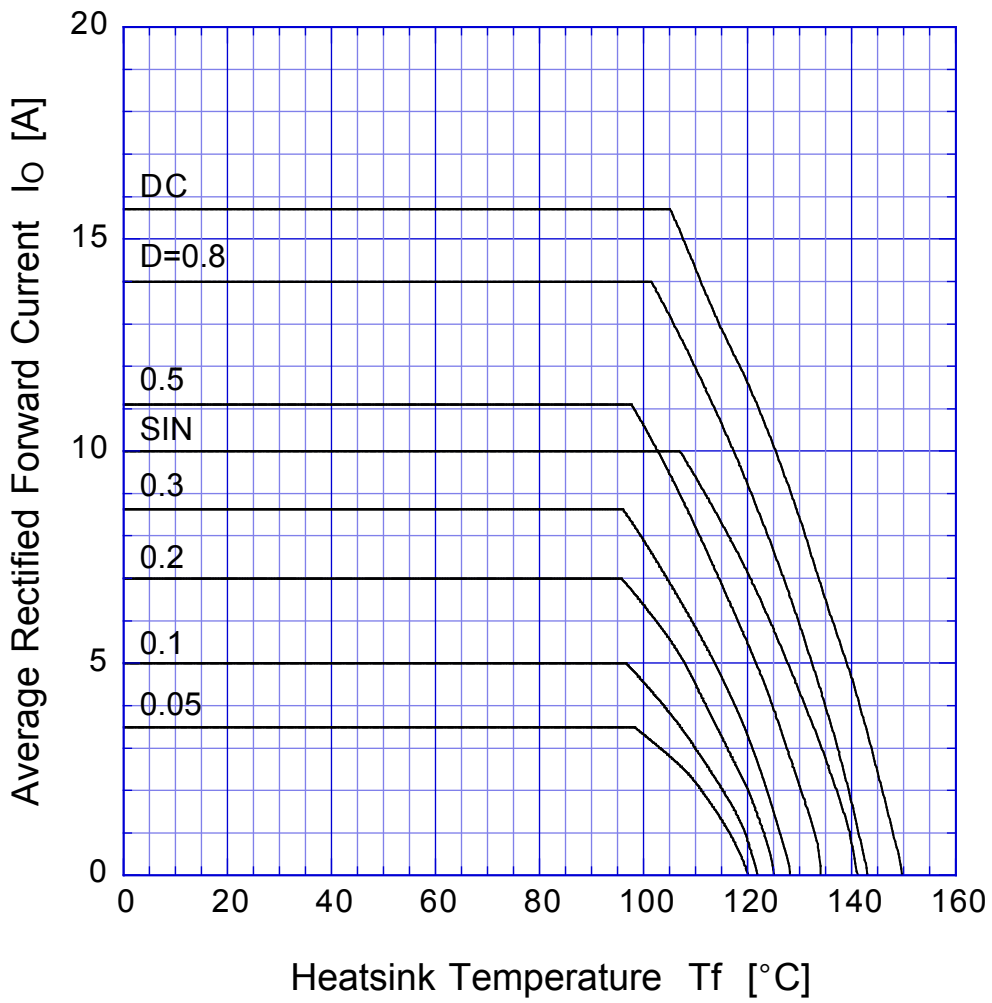

$V_R = 30V$

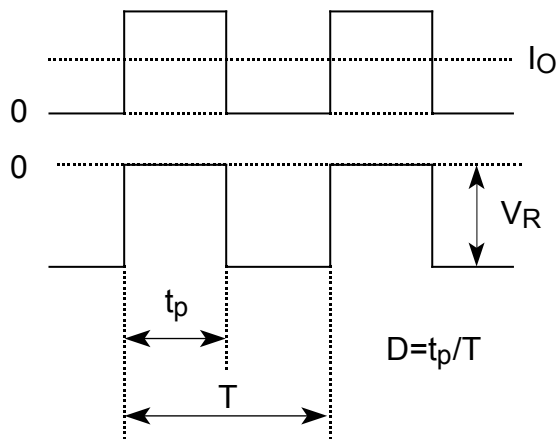

D10SC6MR Peak Surge Forward Capability

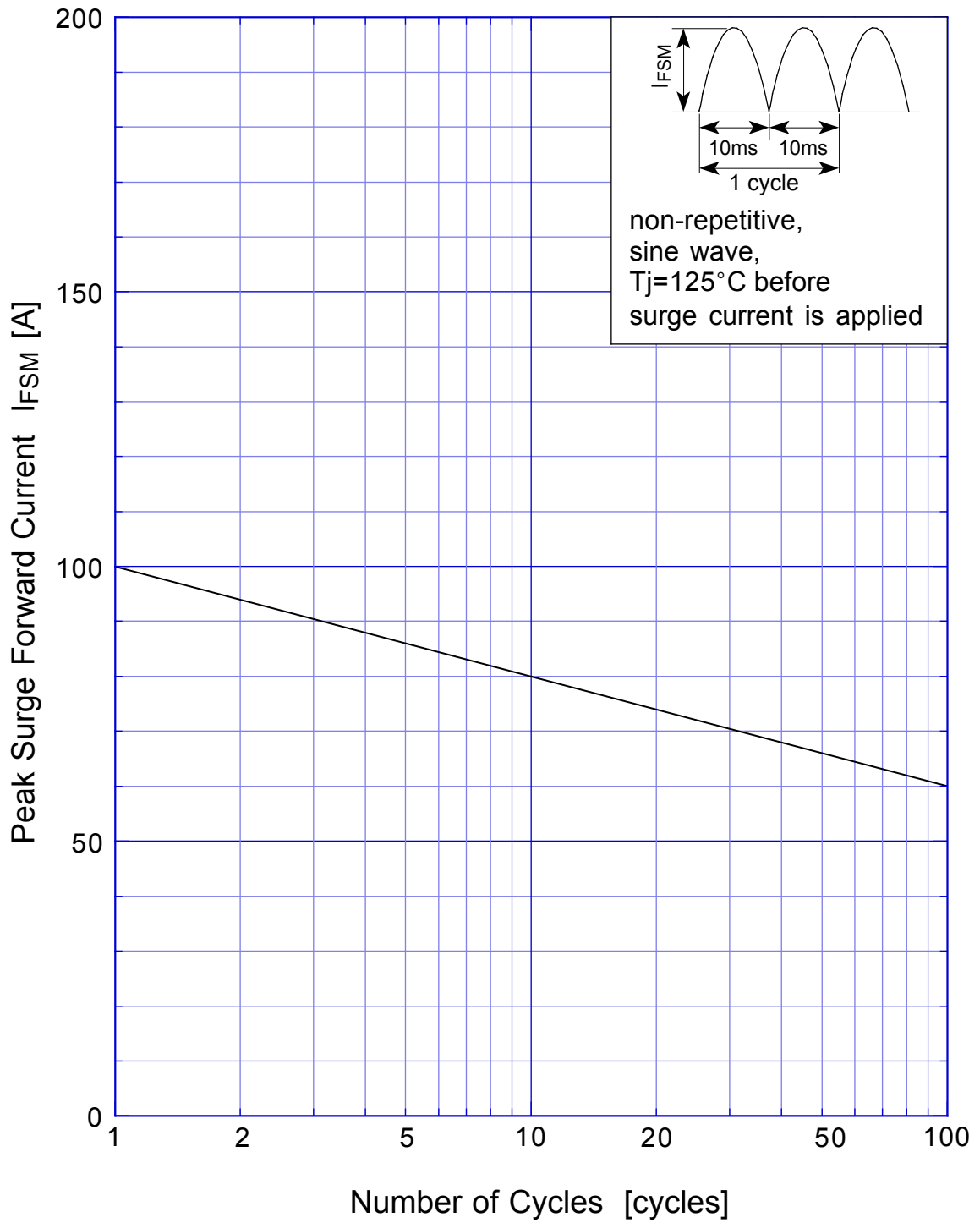

SBD Repetitive Surge Reverse Power Derating Curve



SBD

Repetitive Surge Reverse Power Capability

