

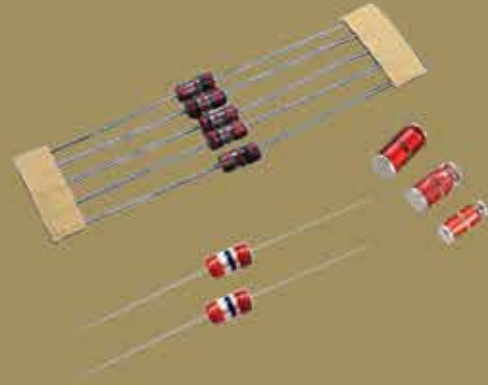

WORLD PRODUCTS INC.

SPARK GAP PROTECTORS



WORLD PRODUCTS INC. || 19654 Eighth Street East || P.O. Box 517 || Sonoma, CA 95476
Phone: (707) 996.5201 || FAX: (707) 996.3380 || www.worldproducts.com || sales@worldproducts.com
©2013 World Products Inc.



THIS PAGE INTENTIONALLY LEFT BLANK.

Table of Contents

L Series - Low Current Axial Lead Type 2

M Series - Medium Current Axial Lead Type 6

H Series - High Current Axial Lead Type 10

HX Series - Super High Current Axial Lead Type 14

LS Series - Low Current SMD Type 18

MS Series - Medium Current SMD Type 22

HS Series - High Current SMD Type 26

WPSPG Spark Gap Protectors – L Series

Part Numbering System

WPSPG - 20 L 200 TA
(1) (2) (3) (4) (5)

(1) World Products Spark Gap Protector

(2) DC Spark-over Voltage
Tolerance: (Example: 20=20% tolerance)

(3) Series Type
L= Low Current

(4) DC Spark-over Voltage:
(Example: 200 = 200V)

(5) Packaging:
Nil = Bulk
TA = Taped/Ammo Box



FEATURES:

1. RoHS Compliant and Halogen Free
2. UL497B – PENDING
3. Fast Responding
4. Low Capacitance
5. Zero leakage current
6. Stable electrical characteristics over time
7. Can withstand repeated surges
8. Symmetrical
9. Operate and storage temperature: -40°C to +85°C

WPSPG Spark Gap Protectors - L Series

DIMENSIONS in mm.

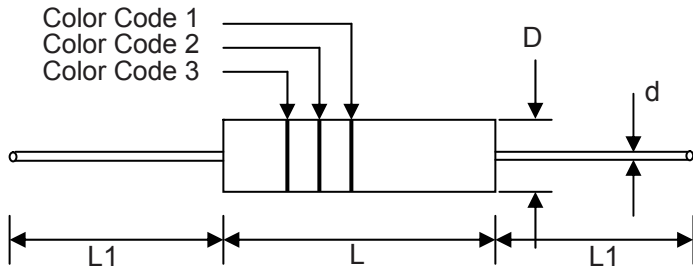

Item	
L	4.0 ± 0.5
L1	28.0 ± 3.0
D	2.0 ± 0.5
d	0.5 ± 0.05

ELECTRICAL CHARACTERISTICS

Part Number	DC Spark-Over Voltage Vs (V)	Minimum Insulation Resistance		Maximum Capacitance (1KHz-6V _{MAX}) C (pf)	Surge current capacity (8/20µs)	Surge Life Test (8/20µs)
		Test Voltage (V)	IR OHM (MΩ)			
WPSPG-XXL 140	140	50	100	0.8	>500A	100A >150 times
WPSPG-XXL 200	200	100	100	0.8		
WPSPG-XXL 220	220	100	100	0.8		
WPSPG-XXL 300	300	100	100	0.8		
WPSPG-XXL 400	400	250	100	0.8		
WPSPG-XXL 500	500	250	100	0.8		
WPSPG-XXL 600	600	250	100	0.8		
WPSPG-XXL 700	700	250	100	0.8		
WPSPG-XXL 1000	1000	500	100	0.8		
WPSPG-XXL 1500	1500	500	100	0.8		

Note: Vs±XX% (DC Spark-over Voltage Tolerance 30% and 20%),140V device is only available in 30% tolerance.

WPSPG Spark Gap Protectors - L Series

COLOR CODE

Part Number	Color Code 1	Color Code 2	Color Code 3
WPSPG-XXL140	Black	Yellow	—
WPSPG-XXL200	Red	—	—
WPSPG-XXL220	Red	Red	—
WPSPG-XXL300	Orange	—	—
WPSPG-XXL400	Yellow	—	—
WPSPG-XXL500	Green	—	—
WPSPG-XXL600	Blue	—	—
WPSPG-XXL700	White	Brown	—
WPSPG-XXL1000	Black	—	—
WPSPG-XXL1500	Brown	Green	Red

TEST METHODS AND RESULTS

ITEM	TEST METHOD	STANDARD						
DC Spark over Voltage(Vs)	Measure starting discharge voltage (Vs) by gradually increasing applied DC voltage. Test current is 0.5mA max. And the DC voltage ascends up within as follow condition. <table border="1" style="margin-left: 20px;"> <tr> <td>Vs <1000V</td> <td>100V/second</td> </tr> <tr> <td>Vs >1000V</td> <td>500V/second</td> </tr> </table>	Vs <1000V	100V/second	Vs >1000V	500V/second	Meet specified value.		
Vs <1000V	100V/second							
Vs >1000V	500V/second							
Insulation Resistance(IR)	Measure the insulation resistance across the terminal at regular voltage. But the test voltage doesn't go beyond the DC spark-over voltage.							
Capacitance	Measure the electrostatic capacitance by applying a voltage of less than 6V (at 1KHZ) between terminals.							
Static Life	10KV with 1500pf condenser is discharged through 0Ω resistor. 200 times at an interval of 10sec.	Rate of change ≤30%. Characteristics of other items must meet the specified value.						
Surge Current Capacity	The following impulse current for specified current applied ± 5 times at 60 seconds intervals. Thereafter, outer appearance shall be visually examined. <table border="1" style="margin-left: 20px;"> <tr> <th>Type</th> <th>Impulse current</th> </tr> <tr> <td>Vs < 400V</td> <td>1.2/50μs & 8/20μs, 500A</td> </tr> <tr> <td>Vs > 400V</td> <td>1.2/50μs & 8/20μs, 500A, electrically connected with a resistor (1~2 Ω).</td> </tr> </table>	Type	Impulse current	Vs < 400V	1.2/50μs & 8/20μs, 500A	Vs > 400V	1.2/50μs & 8/20μs, 500A, electrically connected with a resistor (1~2 Ω).	No crack and no failures.
Type	Impulse current							
Vs < 400V	1.2/50μs & 8/20μs, 500A							
Vs > 400V	1.2/50μs & 8/20μs, 500A, electrically connected with a resistor (1~2 Ω).							
Cold Resistance	Measurement after -40°C/1000 HRS & normal temperature/2 HRS.	Features are conformed to rated spec.						
Heat Resistance	Measurement after 125°C/1000 HRS & normal temperature/2 HRS.							
Humidity Resistance	Measurement after humidity 90~95%(45°C) /1000 HRS & normal temperature/2 HRS.							
Temperature Cycle	10 times repetition of cycle -40°C/30min normal, temp/2 min 125°C/30min, measurement after normal temp/2 HRS.							
Solder Ability	Apply flux and immerse in molten solder 230±5°C for 3sec up to the point of 1.5mm from body. Check for solder adhesion.	Lead wire is evenly covered by solder.						
Solder Heat	Measurement after lead wire is dipped up to the point of 1.5mm from body into 260±5°C solder for 10sec.	Conformed to rated spec.						
Pull Strength	Apply 0.5kg load for 10sec.	Lead shall not pull out or snap.						
Flexural Strength	Bend lead wire at the point of 2mm from body under 0.25 load and back to its original point. Repeat 1 time.							

WPSPG Spark Gap Protectors - L Series

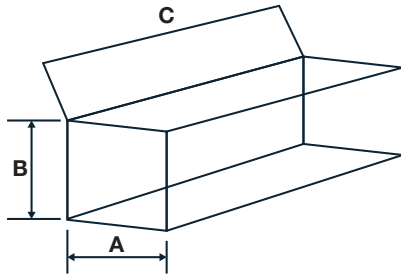

unit: mm

Item	Dimensions
A	78
B	78
C	255

SERIES	Minimum Package Quantity
L	5000 pcs
M	2500 pcs
H	1500 pcs

INNER BOX DIMENSIONS

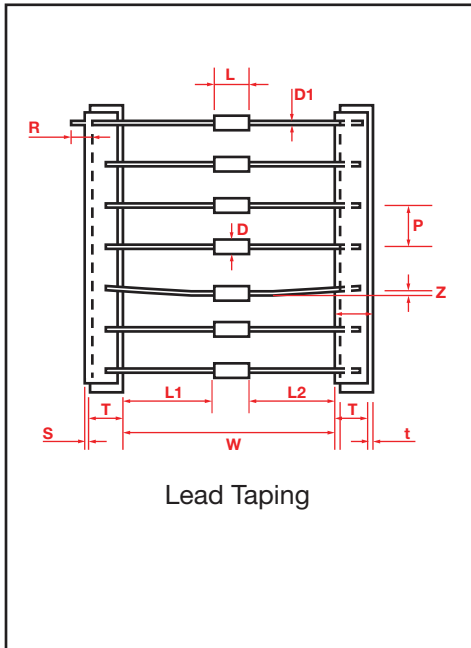

ITEM	Dimensions (mm)
W	52 ± 1.5
P	5.0 ± 0.5
T	6.0 ± 1.0
Z	1.2 max.
R	Leads cannot extend beyond tape.
t	3.2 max.
S	0.8 max.
D	1.5 ~ 4.5
D1	0.5 ± .05
L	4.5 max
L1 & L2	1 max

Flow/wave Soldering Recommendation Parameters

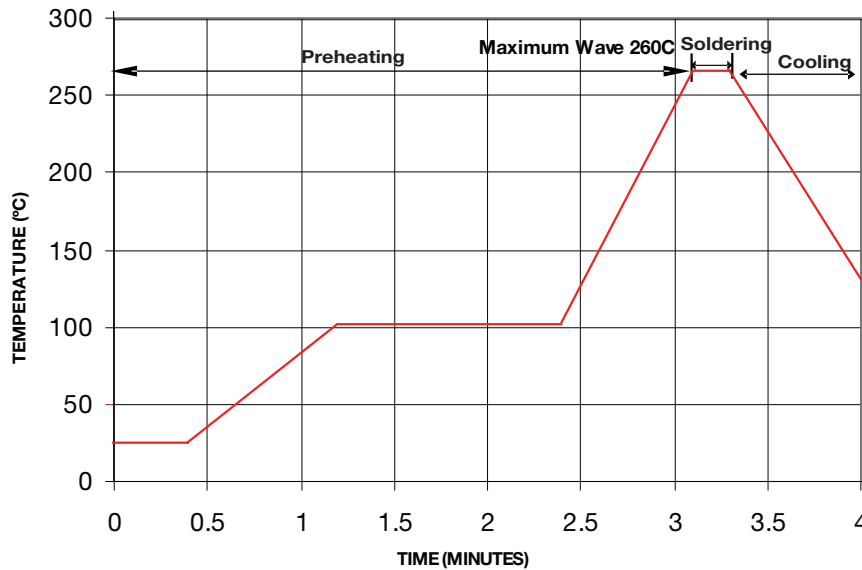

Item	Conditions
Peak Temperature	260 °C
Dipping Time	10 seconds
Soldering	1 time

WPSPG Spark Gap Protectors – M Series

Part Numbering System

WPSPG - 20 M 200 TA
(1) (2) (3) (4) (5)

(1) World Products Spark Gap Protector

(2) DC Spark-over Voltage
Tolerance: (Example: 20=20% tolerance)

(3) Series Type
M = Medium Current

(4) DC Spark-over Voltage:
(Example: 200 = 200V)

(5) Packaging:
Nil = Bulk
TA = Taped/Ammo Box



FEATURES:

1. RoHS Compliant and Halogen Free
2. UL497B – File #E135015 (see specific voltage values)
3. Fast Responding
4. Low Capacitance
5. Zero leakage current
6. Stable electrical characteristics over time
7. Can withstand repeated surges
8. Symmetrical

WPSPG Spark Gap Protectors - M Series

DIMENSIONS in mm.

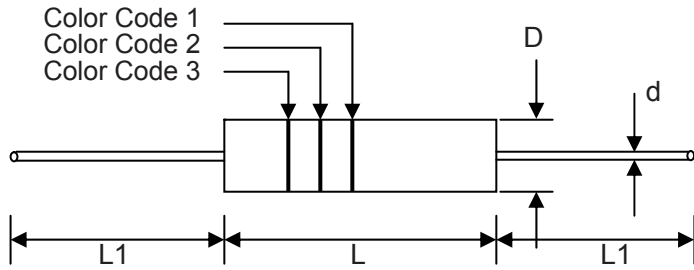

Item	
L	4.3 ± 0.5
L1	28.0 ± 3.0
D	φ2.6 ± 0.5
d	φ0.5 ± 0.05

ELECTRICAL CHARACTERISTICS

Part Number	DC Spark-Over Voltage Vs (V)	Minimum Insulation Resistance		Maximum Capacitance (1KHz-6V _{MAX}) C (pf)	Surge current capacity (8/20μs) >1000A	Surge Life Test (8/20μs) 100A >200 times
		Test Voltage (V)	IR OHM (MΩ)			
*WPSPG-XXM140	140	50	100	0.8	>1000A	100A >200 times
*WPSPG-XXM200	200	100	100	0.8		
*WPSPG-XXM220	220	100	100	0.8		
*WPSPG-XXM300	300	100	100	0.8		
*WPSPG-XXM400	400	250	100	0.8		
*WPSPG-XXM500	500	250	100	0.8		
WPSPG-XXM600	600	250	100	0.8		
WPSPG-XXM700	700	250	100	0.8		
WPSPG-XXM1000	1000	500	100	0.8		
WPSPG-XXM1500	1500	500	100	0.8		

Note: Vs±XX% (DC Spark-over Voltage Tolerance 30% and 20%), 140V device is only available in 30% tolerance.

*UL 497B recognized (30% tolerance only).

WPSPG Spark Gap Protectors - M Series

COLOR CODE

Part Number	Color Code 1	Color Code 2	Color Code 3
WPSPG-XXM140	Black	Yellow	—
WPSPG-XXM200	Red	—	—
WPSPG-XXM220	Red	Red	—
WPSPG-XXM300	Orange	—	—
WPSPG-XXM400	Yellow	—	—
WPSPG-XXM500	Green	Green	—
WPSPG-XXM600	Blue	—	—
WPSPG-XXM700	Purple	—	—
WPSPG-XXM1000	Black	—	—
WPSPG-XXM1500	Brown	Green	Red

TEST METHODS AND RESULTS

ITEM	TEST METHOD	STANDARD						
DC Spark over Voltage(Vs)	<p>Measure starting discharge voltage (Vs) by gradually increasing applied DC voltage. Test current is 0.5mA max. And the DC voltage ascends up within as follow condition.</p> <table border="1"> <tr> <td>Vs <1000V</td> <td>100V/second</td> </tr> <tr> <td>Vs >1000V</td> <td>500V/second</td> </tr> </table>	Vs <1000V	100V/second	Vs >1000V	500V/second	Meet specified value		
Vs <1000V	100V/second							
Vs >1000V	500V/second							
Insulation Resistance(IR)	Measure the insulation resistance across the terminal at regular voltage. But the test voltage doesn't go beyond the DC spark-over voltage.							
Capacitance	Measure the electrostatic capacitance by applying a voltage of less than 6V (at 1KHZ) between terminals.							
Static Life	10KV with 1500pf condenser is discharged through 0Ω resistor. 200 times at an interval of 10sec.	Rate of change ≤30%. Characteristics of other items must meet the specified value.						
Surge Current Capacity	<p>The following impulse current for specified current applied ± 5 times at 60 seconds intervals. Thereafter, outer appearance shall be visually examined.</p> <table border="1"> <tr> <th>Type</th> <th>Impulse current</th> </tr> <tr> <td>Vs < 400V</td> <td>1.2/50µs & 8/20µs, 1000A</td> </tr> <tr> <td>Vs > 400V</td> <td>1.2/50µs & 8/20µs, 1000A, electrically connected with a resistor (1~2 Ω).</td> </tr> </table>	Type	Impulse current	Vs < 400V	1.2/50µs & 8/20µs, 1000A	Vs > 400V	1.2/50µs & 8/20µs, 1000A, electrically connected with a resistor (1~2 Ω).	No crack and no failures
Type	Impulse current							
Vs < 400V	1.2/50µs & 8/20µs, 1000A							
Vs > 400V	1.2/50µs & 8/20µs, 1000A, electrically connected with a resistor (1~2 Ω).							
Cold Resistance	Measurement after -40°C/1000 HRS & normal temperature/2 HRS.	Features are conformed to rated spec.						
Heat Resistance	Measurement after 125°C/1000 HRS & normal temperature/2 HRS.							
Humidity Resistance	Measurement after humidity 90~95% (45°C) /1000 HRS & normal temperature/2 HRS.							
Temperature Cycle	10 times repetition of cycle -40°C/30min normal, temp/2 min 125°C/30min, measurement after normal temp/2 HRS.							
Solder Ability	Apply flux and immerse in molten solder 230± 5°C for 3sec up to the point of 1.5mm from body. Check for solder adhesion.	Lead wire is evenly covered by solder.						
Solder Heat	Measurement after lead wire is dipped up to the point of 1.5mm from body into 260± 5°C solder for 10sec.	Conformed to rated spec.						
Pull Strength	Apply 0.5kg load for 10sec.	Lead shall not pull out or snap.						
Flexural Strength	Bend lead wire at the point of 2mm from body under 0.25 load and back to its original point. Repeat 1 time.							

WPSPG Spark Gap Protectors - M Series

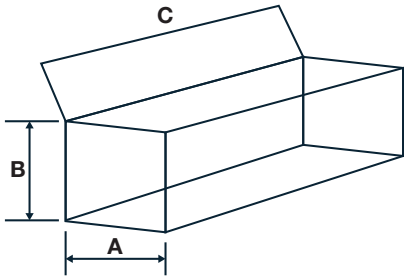

unit: mm
Item **Dimensions**
 A 78
 B 78
 C 255

SERIES	Minimum Package Quantity
L	5000 pcs
M	2500 pcs
H	1500 pcs

INNER BOX DIMENSIONS

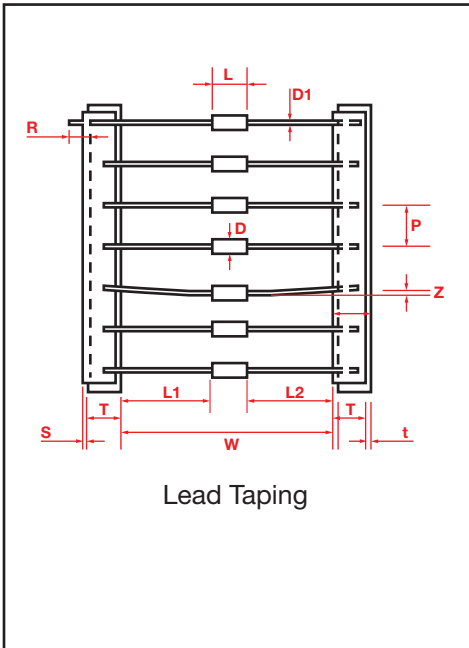

ITEM	Dimensions (mm)
W	52 ± 1.5
P	5.0 ± 0.5
T	6.0 ± 1.0
Z	1.2 max.
R	Leads cannot extend beyond tape.
t	3.2 max.
S	0.8 max.
D	1.5 ~ 4.5
D1	0.5 ± .05
L	3.0 - 7.5
L1 & L2	1 max

Flow/wave Soldering Recommendation Parameters

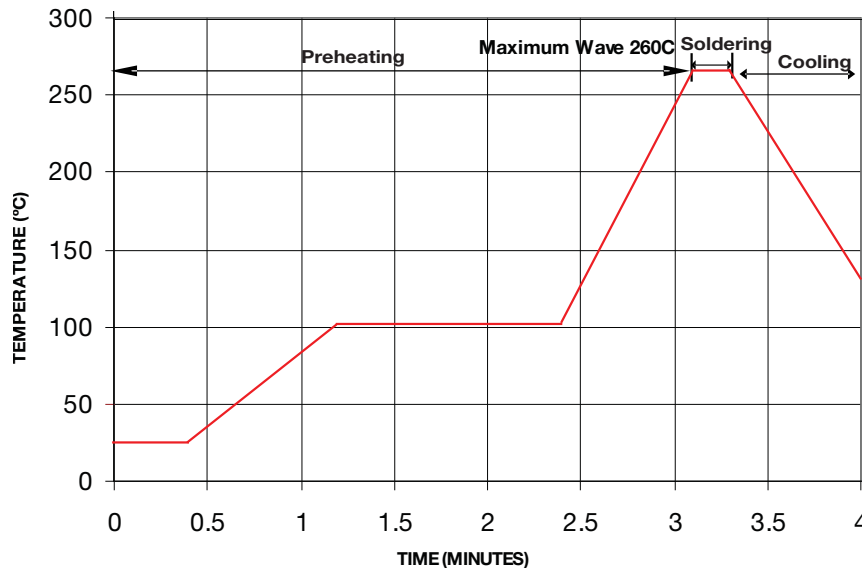

Item	Conditions
Peak Temperature	260 °C
Dipping Time	10 seconds
Soldering	1 time

WPSPG Spark Gap Protectors – H Series

Part Numbering System

WPSPG - 20 H 200 TA
(1) (2) (3) (4) (5)

(1) World Products Spark Gap Protector

(2) DC Spark-over Voltage
Tolerance: (Example: 20=20% tolerance)

(3) Series Type
H= High Current

(4) DC Spark-over Voltage:
(Example: 200 = 200V)

(5) Packaging:
Nil = Bulk
TA = Taped/Ammo Box



FEATURES:

1. RoHS Compliant and Halogen Free
2. UL497B – File #E135015 (see specific voltage values)
3. Fast Responding
4. Low Capacitance
5. Zero leakage current
6. Stable electrical characteristics over time
7. Can withstand repeated surges
8. Symmetrical

WPSPG Spark Gap Protectors - H Series

DIMENSIONS (in mm)

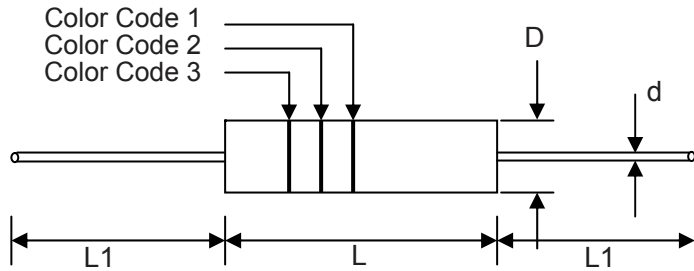

Item		DC Spark-Over Voltage
L	4.0±0.5	140V – 700V
	5.3±0.5	1000V – 5000V
L1	28.0±3.0	
D	3.1±0.5	
d	0.5±0.05	

ELECTRICAL CHARACTERISTICS

Part Number	DC Spark-Over Voltage Vs (V)	Minimum Insulation Resistance		Maximum Capacitance (1KHz-6V _{MAX}) C (pf)	Surge current capacity (8/20µs)	Surge Life Test (8/20µs)
		Test Voltage (V)	IR OHM (MΩ)			
*WPSPG-XXH140	140	50	100	0.8	>3000A	100A >250 times
*WPSPG-XXH200	200	100	100	0.8		
*WPSPG-XXH300	300	100	100	0.8		
*WPSPG-XXH400	400	250	100	0.8		
*WPSPG-XXH500	500	250	100	0.8		
WPSPG-XXH700	700	250	100	0.8		
WPSPG-XXH1000	1000	500	100	0.8	**>2000A	
WPSPG-XXH1500	1500	500	100	0.8		
WPSPG-XXH1800	1800	500	100	0.8		
WPSPG-XXH2000	2000	500	100	0.8		
WPSPG-XXH2400	2400	500	100	0.8		
WPSPG-XXH2700	2700	500	100	0.8		
WPSPG-XXH3000	3000	500	100	0.8		
WPSPG-XXH3600	3600	500	100	0.8		
WPSPG-XXH4000	4000	500	100	0.8		
WPSPG-XXH4500	4500	500	100	0.8		
WPSPG-XXH5000	5000	500	100	0.8		

Note: Vs±XX% (DC Spark-over Voltage Tolerance 30% and 20%), 140V device is only available in 30% tolerance.

* UL497B Recognized (30% tolerance only).

**Parts rated 1000V – 5000V 1.2/50µs and 8/20µs, with 3000A rating add “X” suffix to part number.

WPSPG Spark Gap Protectors - H Series

COLOR CODE

PartNumber	Color Code 1	Color Code 2	Color Code 3
WPSPG-XXH140	Black	Yellow	—
WPSPG-XXH200	Red	—	—
WPSPG-XXH300	Orange	—	—
WPSPG-XXH400	Yellow	—	—
WPSPG-XXH500	Green	—	—
WPSPG-XXH700	Purple	—	—
WPSPG-XXH1000	Brown	Black	Red
WPSPG-XXH1500	Brown	Green	Red
WPSPG-XXH1800	Brown	Gray	Red
WPSPG-XXH2000	Red	Black	Red
WPSPG-XXH2400	Red	Yellow	Red
WPSPG-XXH2700	Red	Purple	Red
WPSPG-XXH3000	Orange	Black	Red
WPSPG-XXH3600	Orange	Blue	Red
WPSPG-XXH4000	Yellow	Black	Red
WPSPG-XXH4500	Yellow	Green	Red
WPSPG-XXH5000	Green	Black	Red

TEST METHODS AND RESULTS

ITEM	TEST METHOD	STANDARD						
DC Spark over Voltage(Vs)	<p>Measure starting discharge voltage (Vs) by gradually increasing applied DC voltage. Test current is 0.5mA max. And the DC voltage ascends up within as follow condition.</p> <table border="1"> <tr> <td>Vs <1000V</td> <td>100V/second</td> </tr> <tr> <td>Vs >1000V</td> <td>500V/second</td> </tr> </table>	Vs <1000V	100V/second	Vs >1000V	500V/second	Meet specified value		
Vs <1000V	100V/second							
Vs >1000V	500V/second							
Insulation Resistance(IR)	Measure the insulation resistance across the terminal at regular voltage. But the test voltage doesn't go beyond the DC spark-over voltage.							
Capacitance	Measure the electrostatic capacitance by applying a voltage of less than 6V (at 1KHZ) between terminals.							
Static Life	10KV with 1500pf condenser is discharged through 0Ω resistor. 200 times at an interval of 10sec.	Rate of change ≤30%. Characteristics of other items must meet the specified value.						
Surge Current Capacity	<p>The following impulse current for specified current applied ± 5 times at 60 seconds intervals. Thereafter, outer appearance shall be visually examined.</p> <table border="1"> <tr> <th>Type</th> <th>Impulse current</th> </tr> <tr> <td>Vs <1000V</td> <td>1.2/50μs & 8/20μs, 3000A, electrically connected with a resistor (1~2 Ω).</td> </tr> <tr> <td>Vs >1000V</td> <td>1.2/50μs & 8/20μs, 3000A, electrically connected with a resistor (4~6 Ω).</td> </tr> </table>	Type	Impulse current	Vs <1000V	1.2/50μs & 8/20μs, 3000A, electrically connected with a resistor (1~2 Ω).	Vs >1000V	1.2/50μs & 8/20μs, 3000A, electrically connected with a resistor (4~6 Ω).	No crack and no failures
Type	Impulse current							
Vs <1000V	1.2/50μs & 8/20μs, 3000A, electrically connected with a resistor (1~2 Ω).							
Vs >1000V	1.2/50μs & 8/20μs, 3000A, electrically connected with a resistor (4~6 Ω).							
Cold Resistance	Measurement after -40°C/1000 HRS & normal temperature/2 HRS.	Features are conformed to rated spec.						
Heat Resistance	Measurement after 125°C/1000 HRS & normal temperature/2 HRS.							
Humidity Resistance	Measurement after humidity 90~95%(45°C) /1000 HRS & normal temperature/2 HRS.							
Temperature Cycle	10 times repetition of cycle -40°C/30min normal, temp/2 min 125°C/30min, measurement after normal temp/2 HRS.							
Solder Ability	Apply flux and immerse in molten solder 230±5°C for 3sec up to the point of 1.5mm from body. Check for solder adhesion.	Lead wire is evenly covered by solder.						
Solder Heat	Measurement after lead wire is dipped up to the point of 1.5mm from body into 260±5°C solder for 10sec.	Conformed to rated spec.						
Pull Strength	Apply 0.5kg load for 10sec.	Lead shall not pull out or snap.						
Flexural Strength	Bend lead wire at the point of 2mm from body under 0.25 load and back to its original point. Repeat 1 time.							

WPSPG Spark Gap Protectors - H Series

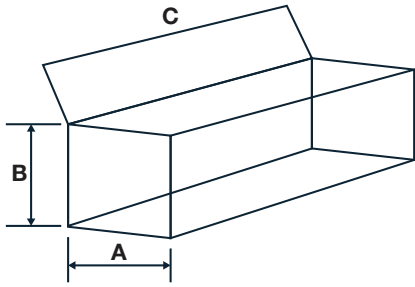

unit: mm

Item	Dimensions
A	78
B	78
C	255

SERIES	Minimum Package Quantity
L	5000 pcs
M	2500 pcs
H	1500 pcs

INNER BOX DIMENSIONS

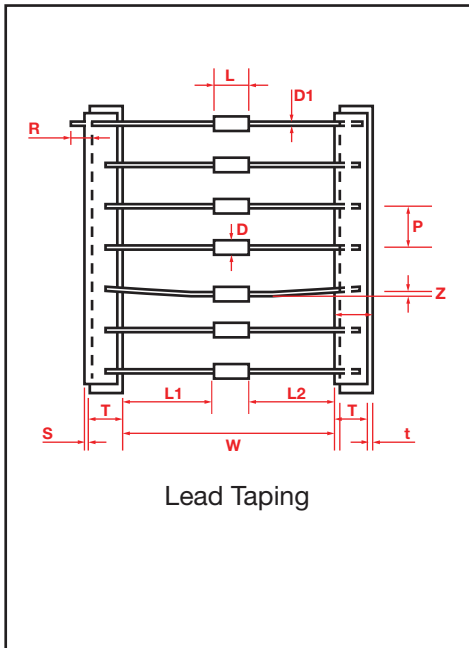

ITEM	Dimensions (mm)
W	52 ± 1.5
P	5.0 ± 0.5
T	6.0 ± 1.0
Z	1.2 max.
R	Leads cannot extend beyond tape.
t	3.2 max.
S	0.8 max.
D	1.5 ~ 4.5m
D1	0.5 ± .05
L	3.0 - 7.5
L1 & L2	1 max

Flow/wave Soldering Recommendation Parameters

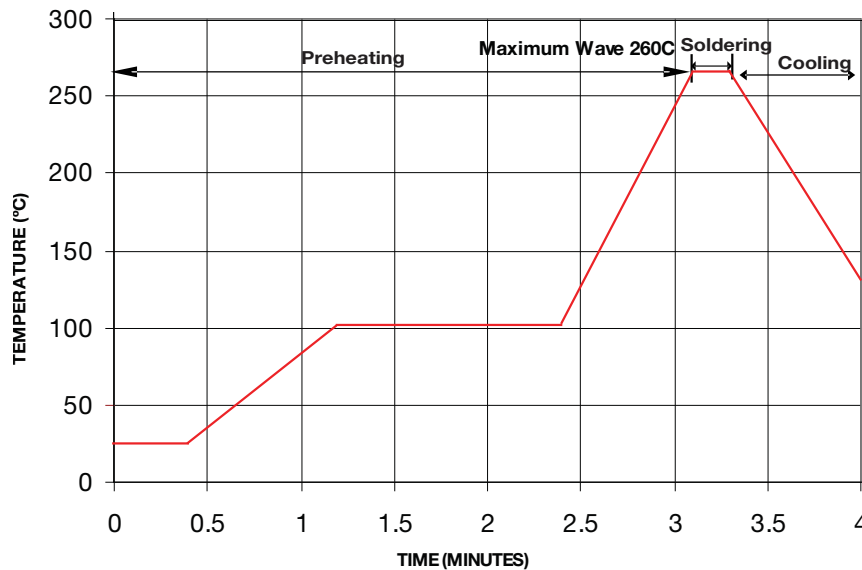

Item	Conditions
Peak Temperature	260 °C
Dipping Time	10 seconds
Soldering	1 time

WPSPG Spark Gap Protectors – HX Series

Part Numbering System

WPSPG - 20 HX 1000 TA
(1) (2) (3) (4) (5)

(1) World Products Spark Gap Protector

(2) DC Spark-over Voltage
Tolerance: (Example: 20=20% tolerance)

(3) Series Type
HX = Super High Current/High Voltage

(4) DC Spark-over Voltage:
(Example: 1000 = 1000V)

(5) Packaging:
Nil = Bulk
TA = Taped/Ammo Box



FEATURES:

1. RoHS Compliant and Halogen Free
2. UL Pending
3. Fast Responding
4. Low Capacitance
5. Zero leakage current
6. Stable electrical characteristics over time
7. Can withstand repeated surges
8. Bilateral and Symmetrical
9. Micro-gap design and low clamping
10. No dark effect

WPSPG Spark Gap Protectors - HX Series

DIMENSIONS (in mm)

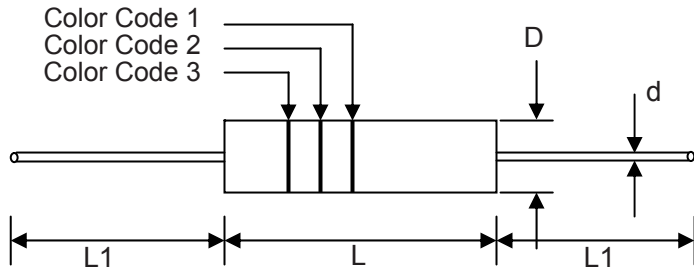

Item	
L	9.0 ± 1.5
L1	28.0 ± 3.0
D	4.1 ± 0.5
d	0.5±0.05

ELECTRICAL CHARACTERISTICS

Part Number	DC Spark-Over Voltage Vs (V)	Minimum Insulation Resistance		Maximum Capacitance (1KHz-6V _{MAX}) C (pf)	Surge current capacity (8/20µs) 3000A	AC Withstanding Voltage
		Test Voltage (V)	IROHM (MΩ)			
WPSPG-XXHX1000	1000	500	100	1.0	3000A	---
WPSPG-XXHX1500	1500	500	100	1.0		---
WPSPG-XXHX1800	1800	500	100	1.0		---
WPSPG-XXHX2000	2000	500	100	1.0		---
WPSPG-XXHX2400	2400	500	100	1.0		1200V (3 sec)
WPSPG-XXHX2700	2700	500	100	1.0		1200V (3 sec)
WPSPG-XXHX3000	3000	500	100	1.0		1500V (3 min)
WPSPG-XXHX3600	3600	500	100	1.0		1800V (3 sec)
WPSPG-XXHX4000	4000	500	100	1.0		1800V (3 sec)
WPSPG-XXHX4500	4500	500	100	1.0		2000V (1 min)
WPSPG-XXHX5000	5000	500	100	1.0	2000V (1 min)	

Note: Vs±XX% (DC Spark-over Voltage Tolerance 30% and 20%).

DC Spark-over Voltage	Measure starting discharge voltage (Vs) by gradually increasing applied DC voltage. Test current is 1.0mA max. And the DC voltage ascends up within 500V/second.
Insulation Resistance	Measure the insulation resistance across the terminal at regular voltage. Test voltage may not exceed the DC spark-over voltage.
Capacitance	Measure the electrostatic capacitance by applying a voltage of less than 6V (at 1KHz) between terminals.

WPSPG Spark Gap Protectors - HX Series

COLOR CODE

Part Number	Color Code 1	Color Code 2	Color Code 3
WPSPG-XXHX1000	Brown	Black	Red
WPSPG-XXHX1500	Brown	Green	Red
WPSPG-XXHX1800	Brown	Gray	Red
WPSPG-XXHX2000	Red	Black	Red
WPSPG-XXHX2400	Red	Yellow	Red
WPSPG-XXHX2700	Red	Purple	Red
WPSPG-XXHX3000	Orange	Black	Red
WPSPG-XXHX3600	Orange	Blue	Red
WPSPG-XXHX4000	Yellow	Black	Red
WPSPG-XXHX4500	Yellow	Green	Red
WPSPG-XXHX5000	Green	Black	Red

TEST METHODS AND RESULTS

Item	Test Method	Standard
Cold Resistance	Measurement after -40°C/48 HRS & normal temperature/2 HRS.	Features are conformed to rated spec.
Heat Resistance	Measurement after +85°C/48 HRS & normal temperature/2 HRS.	
Humidity Resistance	Measurement after humidity 90~95°C (45°C) /48 HRS & normal temperature/2 HRS.	
Temperature Cycle	10 times repetition of cycle -40°C/30min → normal, temp/2 min → 125°C/30min, measurement after normal temp/2 HRS.	
Solder Ability	Apply flux and immerse in molten solder 230±5°C for 3sec up to the point of 1.5mm from body. Check for solder adhesion.	Lead wire is evenly covered by solder.
Solder Heat	Measurement after lead wire is dipped up to the point of 1.5mm from body into 260±5°C solder for 10sec.	Conformed to rated spec.
Pull Strength	Apply 0.5kg load for 10sec.	Lead shall not pull out or snap.
Flexural Strength	Bend lead wire at the point of 2mm from body under 0.25kg load and back to its original point. Repeat 1 time.	
Surge Life	Apply a standard impulse current (8/20µs of 100A) for 300 times at 60 seconds intervals.	No crack and no failures.
Surge Current Capacity	Charge a 1.2/50µs & 8/20µs, 2000A, and apply it to the sample. Do this 10 times. Or 3000A, 1 time.	

WPSPG Spark Gap Protectors - HX Series

Axial Taping Packaging

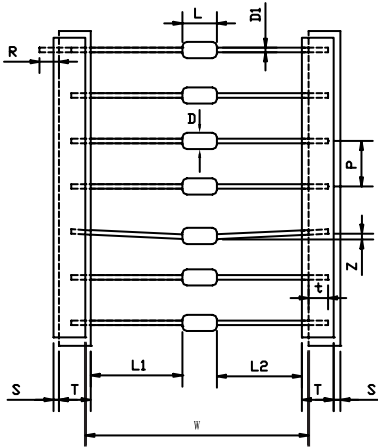

Symbol	Dimension(mm)
W	52.0±1.5
P	10.0±0.5
L1-L2	1.0max.
T	6.0±1.0
Z	1.2max.
R	Terminals must not project from tape.
t	3.2max.
S	0.8max.
D	Φ4.6max.
D1	Φ0.5±0.05
L	10.5max.

Flow/wave Soldering Recommendation Parameters

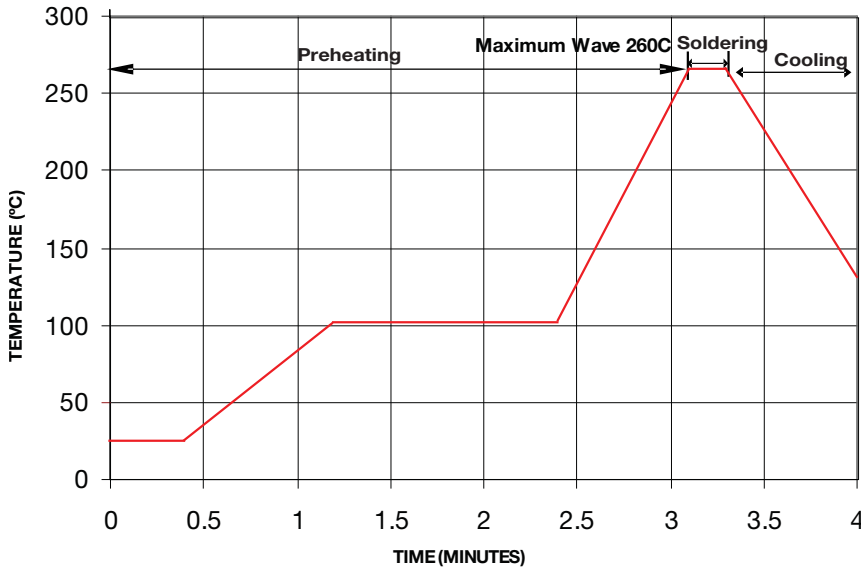

Item	Conditions
Peak Temperature	260 °C
Dipping Time	10 seconds
Soldering	1 time

Inner Box Drawing

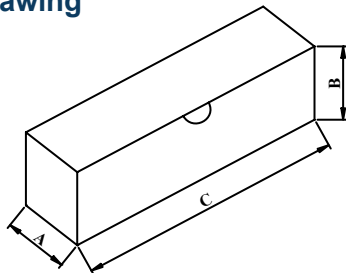

Symbol	Dimension(mm)	Quantity
A	75.0	1000PCS
B	114.0	
C	250.0	

WPSPG Spark Gap Protectors – LS Series

Part Numbering System

WPSPG - 20 LS 200 M
(1) (2) (3) (4) (5)

(1) World Products Spark Gap Protector

(2) DC Spark-over Voltage
Tolerance: (Example: 20=20% tolerance)

(3) Series Type
LS= Low Current Surface Mount Series

(4) DC Spark-over Voltage:
(Example: 200 = 200V)

(5) Nil = Standard Package
M = Mini Melf Package



FEATURES:

1. RoHS Compliant and Halogen Free
2. UL497B – PENDING
3. Fast Responding
4. Low Capacitance
5. Zero leakage current
6. Stable electrical characteristics over time
7. Can withstand repeated surges
8. Symmetrical

WPSPG Spark Gap Protectors - LS Series

DIMENSION in mm.

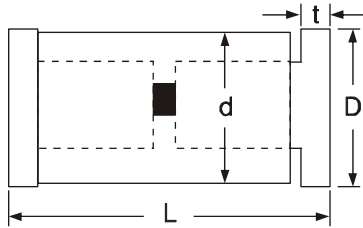

Item	Standard	Mini Melf
L	4.0 ± 0.5	3.4 ± 0.5
D	2.1 ± 0.5	1.4 ± 0.5
d	2.0 ± 0.5	1.3 ± 0.5
t	0.4 ± 0.1	0.4 ± 0.1

ELECTRICAL CHARACTERISTICS

STANDARD Series

Part Number	DC Spark-Over Voltage	Minimum Insulation Resistance		Maximum Capacitance (1KHz-6V _{MAX})	Surge current capacity (8/20μs)
	V _s (V)	Test Voltage(V)	I _{ROHM} (MΩ)	C(pf)	(A)
WPSPG-XXLS140	140	50	100	0.8	500
WPSPG-XXLS200	200	100	100	0.8	500
WPSPG-XXLS220	220	100	100	0.8	500
WPSPG-XXLS300	300	100	100	0.8	500
WPSPG-XXLS400	400	250	100	0.8	500
WPSPG-XXLS500	500	250	100	0.8	500
WPSPG-XXLS600	600	250	100	0.8	500
WPSPG-XXLS700	700	250	100	0.8	500
WPSPG-XXLS1000	1000	500	100	0.8	500

Note: V_s±XX% (DC Spark-over Voltage Tolerance 30% and 20%),140V device is only available in 30% tolerance.

MINI MELF Series

Part Number	DC Spark-Over Voltage	Minimum Insulation Resistance		Maximum Capacitance (1KHz-6V _{MAX})	Surge current capacity (8/20μs)
	V _s (V)	Test Voltage(V)	I _{ROHM} (MΩ)	C(pf)	(A)
WPSPG-XXLS140M	140	50	100	0.8	300
WPSPG-XXLS200M	200	100	100	0.8	300
WPSPG-XXLS300M	300	100	100	0.8	300

Note: V_s±XX% (DC Spark-over Voltage Tolerance 30% and 20%),140V device is only available in 30% tolerance.

WPSPG Spark Gap Protectors - LS Series

TEST METHODS AND RESULTS

ITEM	TEST METHOD	STANDARD						
DC Spark over Voltage(Vs)	<p>Measure starting discharge voltage (Vs) by gradually increasing applied DC voltage. Test current is 0.5mA max. And the DC voltage ascends up within as follow condition.</p> <table border="1"> <tr> <td>Vs <1000V</td> <td>100V/second</td> </tr> <tr> <td>Vs >1000V</td> <td>500V/second</td> </tr> </table>	Vs <1000V	100V/second	Vs >1000V	500V/second	Meet specified value		
Vs <1000V	100V/second							
Vs >1000V	500V/second							
Insulation Resistance(IR)	Measure the insulation resistance across the terminal at regular voltage. But the test voltage doesn't go beyond the DC spark-over voltage.							
Capacitance	Measure the electrostatic capacitance by applying a voltage of less than 6V (at 1KHZ) between terminals.							
Static Life	10KV with 1500pf condenser is discharged through 0Ω resistor. 200 times at an interval of 10sec.	Rate of change 30%. Characteristics of other items must meet the specified value.						
Surge Current Capacity	<p>The following impulse current for specified current applied ± 5 times at 60 seconds intervals. Thereafter, outer appearance shall be visually examined.</p> <table border="1"> <tr> <td>Type</td> <td>Impulse current</td> </tr> <tr> <td>Mini Melf</td> <td>1.2/50µs & 8/20µs, 300A</td> </tr> <tr> <td>Standard</td> <td>1.2/50µs & 8/20µs, 500A</td> </tr> </table>	Type	Impulse current	Mini Melf	1.2/50µs & 8/20µs, 300A	Standard	1.2/50µs & 8/20µs, 500A	No crack and no failures
Type	Impulse current							
Mini Melf	1.2/50µs & 8/20µs, 300A							
Standard	1.2/50µs & 8/20µs, 500A							
Cold Resistance	Measurement after -40°C/1000 HRS & normal temperature/2 HRS.	Features are conformed to rated spec.						
Heat Resistance	Measurement after 125°C/1000 HRS & normal temperature/2 HRS.							
Humidity Resistance	Measurement after humidity 90~95% (45°C) /1000 HRS & normal temperature/2 HRS.							
Temperature Cycle	10 times repetition of cycle -40°C/30min normal, temp/2 min 125°C/30min, measurement after normal temp/2 HRS.							
Solder Ability	Apply flux and immerse in molten solder 230±5°C for 3sec up to the end surface of the electrodes. Check for solder adhesion.	The end surface is evenly covered by solder.						
Solder Heat	Measurement after the end surface of the electrodes is dipped up to into 260±5°C solder for 10sec.	Conformed to rated spec.						

WPSPG Spark Gap Protectors - LS Series

Taping Specifications

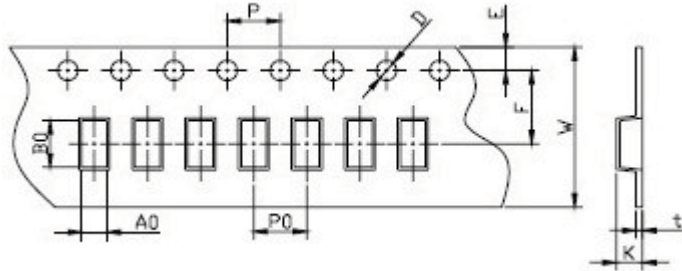

Item	Standard Series	Mini Melf Series
P	4.0 ± 0.1	4.0 ± 0.1
P0	8.0 ± 0.1	4.0 ± 0.1
W	12.0 ± 0.3	8.0 ± 0.3
F	5.5 ± 0.1	3.4 ± 0.1
E	1.75 ± 0.1	1.5 ± 0.1
D	Φ 1.5 ± 0.1	Φ 1.5 ± 0.1
K	2.3 ± 0.2	1.6 ± 0.1
t	0.5 max.	0.2 ± 0.1
A0	2.2 ± 0.1	1.6 ± 0.1
B0	4.3 ± 0.1	4.0 ± 0.1

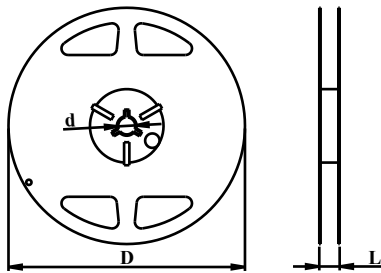

NOTE: 3000 pcs per reel.

Item	Standard Size	Mini Melf Series
D	178mm	178mm
d	13mm	13mm
L	15mm	11mm

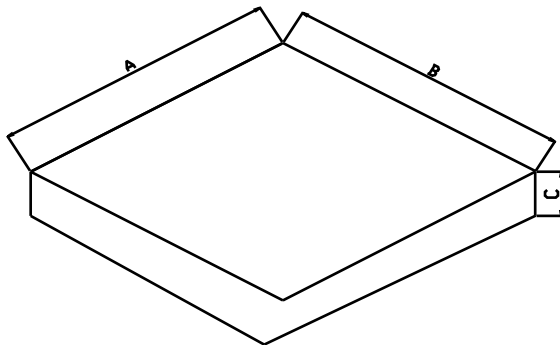

Item	Size (mm)
A	185
B	179
C	67

Note: All dimensions (mm)

WPSPG Spark Gap Protectors - MS Series

DIMENSION in mm.

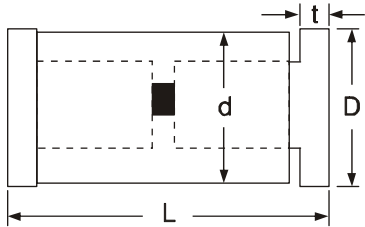

Item	
L	5.0 ± 0.5
D	2.8 ± 0.5
d	2.6 ± 0.5
t	0.4 ± 0.1

ELECTRICAL CHARACTERISTICS

Part Number	DC Spark-Over Voltage	Minimum Insulation Resistance		Maximum Capacitance (1KHz-6V _{MAX})	Surge current capacity (8/20 _{μs})
	V _s (V)	Test Voltage(V)	I _{ROHM} (MΩ)	C(pf)	(A)
*WPSPG-XXMS140	140	50	100	0.8	1000
*WPSPG-XXMS200	200	100	100	0.8	1000
*WPSPG-XXMS220	220	100	100	0.8	1000
*WPSPG-XXMS300	300	100	100	0.8	1000
*WPSPG-XXMS400	400	250	100	0.8	1000
*WPSPG-XXMS500	500	250	100	0.8	1000
WPSPG-XXMS600	600	250	100	0.8	1000
WPSPG-XXMS700	700	250	100	0.8	1000
WPSPG-XXMS1000	1000	500	100	0.8	1000

Note: V_s±XX% (DC Spark-over Voltage Tolerance 30% and 20%), 140V device is only available in 30% tolerance.

*UL 497B recognized (30% tolerance only).

WPSPG Spark Gap Protectors - MS Series

TEST METHODS AND RESULTS

ITEM	TEST METHOD	STANDARD				
DC Spark over Voltage(Vs)	Measure starting discharge voltage (Vs) by gradually increasing applied DC voltage. Test current is 0.5mA max. And the DC voltage ascends up within as follow condition. <table border="1" style="margin-left: auto; margin-right: auto;"> <tr> <td>Vs <1000V</td> <td>100V/second</td> </tr> <tr> <td>Vs >1000V</td> <td>500V/second</td> </tr> </table>	Vs <1000V	100V/second	Vs >1000V	500V/second	Meet specified value
Vs <1000V	100V/second					
Vs >1000V	500V/second					
Insulation Resistance(IR)	Measure the insulation resistance across the terminal at regular voltage. But the test voltage doesn't go beyond the DC spark-over voltage.					
Capacitance	Measure the electrostatic capacitance by applying a voltage of less than 6V (at 1KHZ) between terminals.					
Static Life	10KV with 1500pf condenser is discharged through 0Ω resistor. 200 times at an interval of 10sec.	Rate of change 30%. Characteristics of other items must meet the specified value.				
Surge Current Capacity	The following impulse current for specified current applied ± 5 times at 60 seconds intervals. Thereafter, outer appearance shall be visually examined. <table border="1" style="margin-left: auto; margin-right: auto;"> <tr> <td>Impulse current 1.2/50μs & 8/20μs, 1000A, electrically connected with a resistor (1~2 Ω).</td> </tr> </table>	Impulse current 1.2/50μs & 8/20μs, 1000A, electrically connected with a resistor (1~2 Ω).	No crack and no failures			
Impulse current 1.2/50μs & 8/20μs, 1000A, electrically connected with a resistor (1~2 Ω).						
Cold Resistance	Measurement after -40°C/1000 HRS & normal temperature/2 HRS.	Features are conformed to rated spec.				
Heat Resistance	Measurement after 125°C/1000 HRS & normal temperature/2 HRS.					
Humidity Resistance	Measurement after humidity 90~95%(45°C) /1000 HRS & normal temperature/2 HRS.					
Temperature Cycle	10 times repetition of cycle -40°C/30min normal, temp/2 min 125°C/30min, measurement after normal temp/2 HRS.					
Solder Ability	Apply flux and immerse in molten solder 230± 5°C for 3sec up to the end surface of the electrodes. Check for solder adhesion.					
Solder Heat	Measurement after the end surface of the electrodes is dipped up to into 260± 5°C solder for 10sec.	The end surface is evenly covered by solder.				
		Conformed to rated spec.				

WPSPG Spark Gap Protectors - MS Series

Taping Specifications

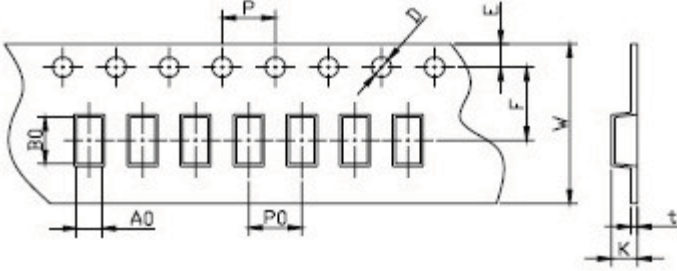

Item	Size (mm)
P	4.0±0.1
P0	4.0±0.1
W	12.0±0.2
F	5.50±0.05
E	1.5±0.1
D	Φ1.5±0.1
K	3.0±0.1
t	0.30±0.05
A0	3.0±0.1
B0	6.0±0.1

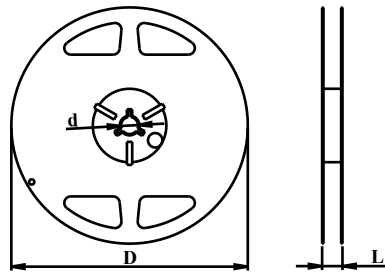

NOTE: 1500 pcs per reel.

Item	Size (mm)
D	178mm
d	13mm
L	15mm

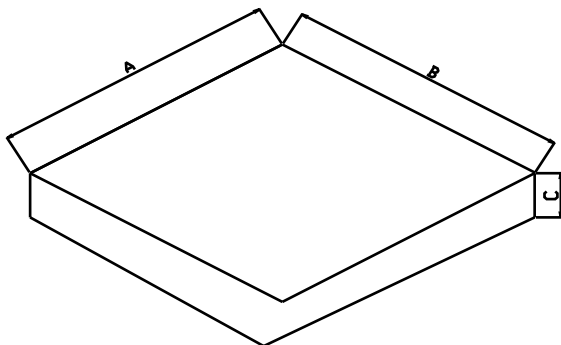

Item	Size (mm)
A	185
B	179
C	67

WPSPG Spark Gap Protectors – HS Series

Part Numbering System

WPSPG - 20 HS 200
(1) (2) (3) (4)

(1) World Products Spark Gap Protector

(2) DC Spark-over Voltage
Tolerance: (Example: 20=20% tolerance)

(3) Series Type
HS= High Current Surface Mount Series

(4) DC Spark-over Voltage:
(Example: 200 = 200V)



FEATURES:

1. RoHS Compliant and Halogen Free
2. UL497B – File #E135015 (see specific voltage values)
3. Fast Responding
4. Low Capacitance
5. Zero leakage current
6. Stable electrical characteristics over time
7. Can withstand repeated surges
8. Symmetrical

WPSPG Spark Gap Protectors - HS Series

DIMENSION

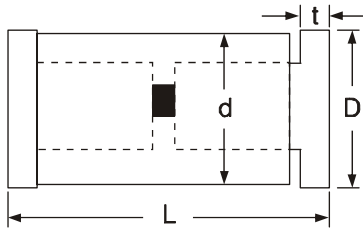

Item	
L	6.0±0.5
D	3.3±0.5
d	3.1±0.5
t	0.4±0.1

ELECTRICAL CHARACTERISTICS

Part Number	DC Spark-Over Voltage	Minimum Insulation Resistance		Maximum Capacitance (1KHz-6V _{MAX})	Surge current capacity (8/20μs)
	Vs(V)	Test Voltage(V)	IR _{OHM} (MΩ)	C(pf)	(A)
*WPSPG-XXHS140	140	50	100	0.8	3000
*WPSPG-XXHS200	200	100	100	0.8	3000
*WPSPG-XXHS300	300	100	100	0.8	3000
*WPSPG-XXHS400	400	250	100	0.8	3000
*WPSPG-XXHS500	500	250	100	0.8	3000
WPSPG-XXHS700	700	250	100	0.8	3000
WPSPG-XXHS1000	1000	500	100	0.8	3000

Note: Vs±XX% (DC Spark-over Voltage Tolerance 30% and 20%),140V device is only available in 30% tolerance.

*UL 497B recognized (30% tolerance only).

WPSPG Spark Gap Protectors - HS Series

TEST METHODS AND RESULTS

ITEM	TEST METHOD	STANDARD				
DC Spark over Voltage(Vs)	<p>Measure starting discharge voltage (Vs) by gradually increasing applied DC voltage. Test current is 0.5mA max. And the DC voltage ascends up within as follow condition.</p> <table border="1"> <tr> <td>Vs <1000V</td> <td>100V/second</td> </tr> <tr> <td>Vs >1000V</td> <td>500V/second</td> </tr> </table>	Vs <1000V	100V/second	Vs >1000V	500V/second	Meet specified value
Vs <1000V	100V/second					
Vs >1000V	500V/second					
Insulation Resistance(IR)	Measure the insulation resistance across the terminal at regular voltage. But the test voltage doesn't go beyond the DC spark-over voltage.					
Capacitance	Measure the electrostatic capacitance by applying a voltage of less than 6V (at 1KHZ) between terminals.					
Static Life	10KV with 1500pf condenser is discharged through 0Ω resistor. 200 times at an interval of 10sec.	Rate of change ≤30%. Characteristics of other items must meet the specified value.				
Surge Current Capacity	<p>The following impulse current for specified current applied ± 5 times at 60 seconds intervals. Thereafter, outer appearance shall be visually examined.</p> <table border="1"> <tr> <td>Impulse current 1.2/50μs & 8/20μs, 3000A, electrically connected with a resistor (2~4Ω).</td> </tr> </table>	Impulse current 1.2/50μs & 8/20μs, 3000A, electrically connected with a resistor (2~4Ω).	No crack and no failures			
Impulse current 1.2/50μs & 8/20μs, 3000A, electrically connected with a resistor (2~4Ω).						
Cold Resistance	Measurement after -40°C/1000 HRS & normal temperature/2 HRS.	Features are conformed to rated spec.				
Heat Resistance	Measurement after 125°C/1000 HRS & normal temperature/2 HRS.					
Humidity Resistance	Measurement after humidity 90~95%(45°C) /1000 HRS & normal temperature/2 HRS.					
Temperature Cycle	10 times repetition of cycle -40°C/30min normal, temp/2 min 125°C/30min, measurement after normal temp/2 HRS.					
Solder Ability	Apply flux and immerse in molten solder 230± 5°C for 3sec up to the end surface of the electrodes. Check for solder adhesion.					
Solder Heat	Measurement after the end surface of the electrodes is dipped up to into 260± 5°C solder for 10sec.	Conformed to rated spec.				

WPSPG Spark Gap Protectors - HS Series

Taping Specifications

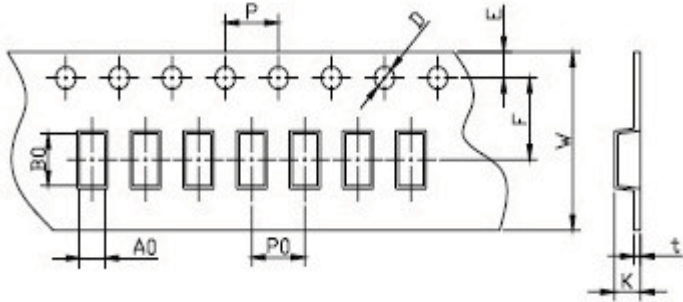

Item	Size (mm)
P	4.0±0.1
P0	8.0±0.1
W	16.00±0.2
F	7.5±0.05
E	1.75±0.1
D	Φ1.5±0.1
K	3.5±0.1
t	0.5Max
A0	3.5 ± 0.1
B0	6.5 ± 0.1

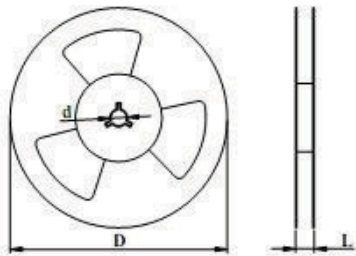

NOTE: 2000 pcs per reel.

Item	Size (mm)
D	330mm
d	13mm
L	20mm

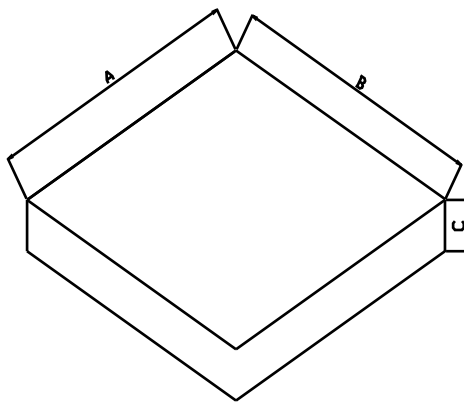

Item	Size (mm)
A	330
B	330
C	40