



X0202/A

SCR

SENSITIVE SCRS

■ **DESCRIPTION**

The UTC **X0202/A** SCR series is suitable for all applications where the available gate current is limited, such as ground fault circuit interruptors, overvoltage crowbar protection in low power supplies, capacitive ignition circuit,

■ **FEATURES**

- * $I_{T(RMS)}$: 1.25A
- * V_{DRM}/V_{RRM} : 600/800V

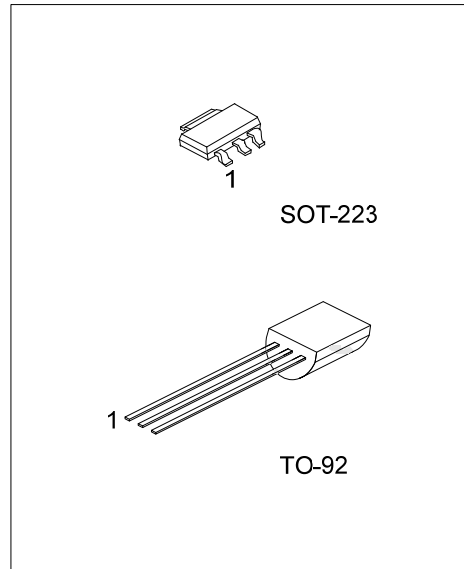

■ **ORDERING INFORMATION**

Ordering Number		Package	Pin Assignment			Packing
Lead Free	Halogen Free		1	2	3	
X0202L-AA3-R	X0202G-AA3-R	SOT-223	K	A	G	Tape Reel
X0202L-T92-B	X0202G-T92-B	TO-92	K	G	A	Tape Box
X0202L-T92-K	X0202G-T92-K	TO-92	K	G	A	Bulk
X0202L-T92-R	X0202G-T92-R	TO-92	K	G	A	Tape Reel
X0202AL-AA3-R	X0202AG-AA3-R	SOT-223	K	A	G	Tape Reel
X0202AL-T92-B	X0202AG-T92-B	TO-92	K	G	A	Tape Box
X0202AL-T92-K	X0202AG-T92-K	TO-92	K	G	A	Bulk
X0202AL-T92-R	X0202AG-T92-R	TO-92	K	G	A	Tape Reel

Note: Pin Assignment: G: Gate A: Anode K: Cathode

<p>X0202L-AA3-R</p> <p>(1)Packing Type (2)Package Type (3)Lead Free</p>	<p>(1) B: Tape Box, K: Bulk, R: Tape Reel (2) AA3: SOT-223, T92: TO-92 (3) G: Halogen Free, L: Lead Free</p>
---	--

■ ABSOLUTE MAXIMUM RATINGS (unless otherwise specified)

PARAMETERS		SYMBOL	RATINGS	UNIT
Peak Repetitive Forward and Reverse Blocking Voltage ($T_J=110^\circ\text{C}$, $R_{GK}=1\text{k}\Omega$)	X0202	V_{DRM} , V_{RRM}	600	V
	X0202A		800	V
RMS On-State Current 180°C Conduction Angle	($T_{tab}=95^\circ\text{C}$)	$I_{T(RMS)}$	1.25	A
Average On-State Current 180°C Conduction Angle	($T_{tab}=95^\circ\text{C}$)	$I_{T(AV)}$	0.8	A
Non Repetitive Surge Peak on-State Current ($t_p=8.3\text{ms}$ $T_J=25^\circ\text{C}$)		I_{TSM}	25	A
Non Repetitive Surge Peak on-State Current ($t_p=10\text{ms}$ $T_J=25^\circ\text{C}$)		I_{TSM}	22.5	A
I^2t Value for Fusing ($t_p=10\text{ms}$ $T_J=25^\circ\text{C}$)		I^2t	2.5	A^2S
Critical Rate Of Rise Of On-state Current $I_G=2 \cdot I_{GT}$, $t_r \leq 100\text{ns}$, $f=60\text{Hz}$, $T_J=125^\circ\text{C}$		di/dt	50	$\text{A}/\mu\text{s}$
Peak Gate Current ($p=20\mu\text{s}$ $T_J=125^\circ\text{C}$)		I_{GM}	1.2	A
Average Gate Power Dissipation ($T_J=125^\circ\text{C}$)		$P_{G(AV)}$	0.2	W
Operating Junction Temperature Range		T_J	-40 ~ +125	$^\circ\text{C}$
Storage Junction Temperature Range		T_{STG}	-40 ~ +150	$^\circ\text{C}$

Note: Absolute maximum ratings are those values beyond which the device could be permanently damaged.

Absolute maximum ratings are stress ratings only and functional device operation is not implied.

■ THERMAL DATA

PARAMETER		SYMBOL	RATINGS	UNIT
Junction to Tab	SOT-223	θ_{JT}	25	$^\circ\text{C}/\text{W}$
	TO-92		60	$^\circ\text{C}/\text{W}$
Junction to Ambient (S=5cm)	SOT-223	θ_{JA}	60	$^\circ\text{C}/\text{W}$
	TO-92		150	$^\circ\text{C}/\text{W}$

S=Copper surface under tab

■ ELECTRICAL CHARACTERISTICS ($T_J=25^\circ\text{C}$, unless otherwise specified)

PARAMETER	SYMBOL	TEST CONDITIONS	MIN	TYP	MAX	UNIT
Peak Forward or Reverse Blocking Current	I_{DRM} , I_{RRM}	$V_{DRM}=V_{RRM}$, $R_{GK}=1\text{k}\Omega$			5	μA
					500	μA
Peak Forward On-State Voltage	V_{TM}	$I_{TM}=2.5\text{A}$, $t_p=380\mu\text{s}$			1.45	V
Gate Trigger Current	I_{GT}	$V_D=12\text{V}$, $R_L=140\Omega$			200	μA
Gate Trigger Voltage	V_{GT}	$V_D=12\text{V}$, $R_L=140\Omega$			0.8	V
Gate Non-Trigger Voltage	V_{GD}	$V_D=V_{DRM}$, $R_L=3.3\text{k}\Omega$, $R_{GK}=1\text{k}\Omega$, ($T_J=125^\circ\text{C}$)	0.1			V
Holding Current	I_H	$I_T=50\text{mA}$, $R_{GK}=1\text{k}\Omega$			5	mA
Latch Current	I_L	$I_G=1\text{mA}$, $R_{GK}=1\text{k}\Omega$			6	mA
Critical Rate of Rise of Off-State Voltage	dv/dt	$V_D=67\%V_{DRM}$, $R_{GK}=1\text{k}\Omega$, ($T_J=110^\circ\text{C}$)	10			$\text{V}/\mu\text{s}$
Peak Reversed Gate Voltage	V_{RG}	$I_{RG}=10\mu\text{A}$	8			V
Threshold Voltage	V_{TO}	($T_J=125^\circ\text{C}$)			0.9	V
Dynamic Resistance	R_d	($T_J=125^\circ\text{C}$)			200	m Ω

■ TYPICAL CHARACTERISTICS

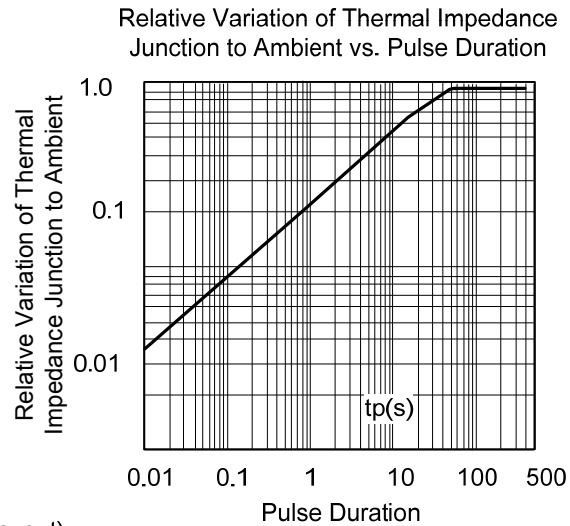
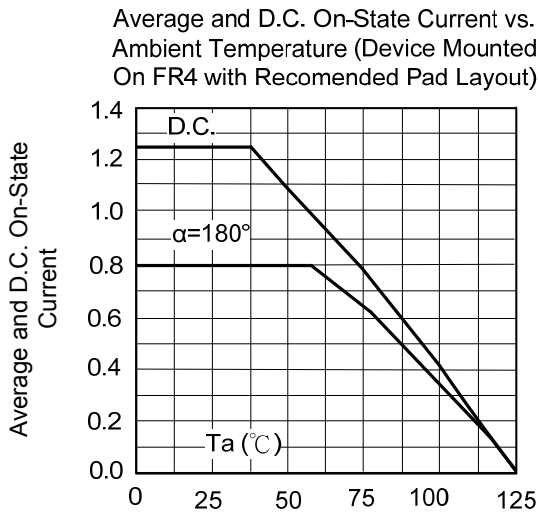
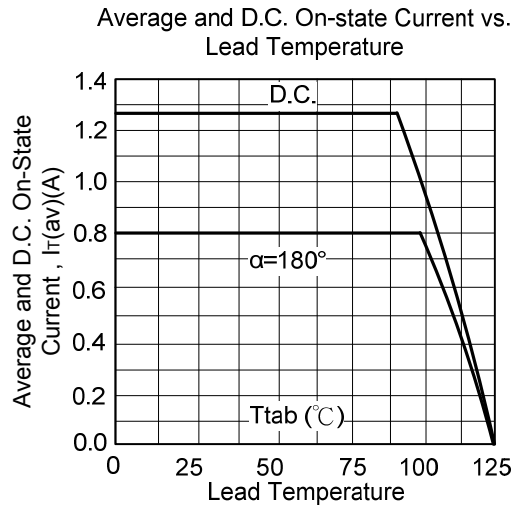
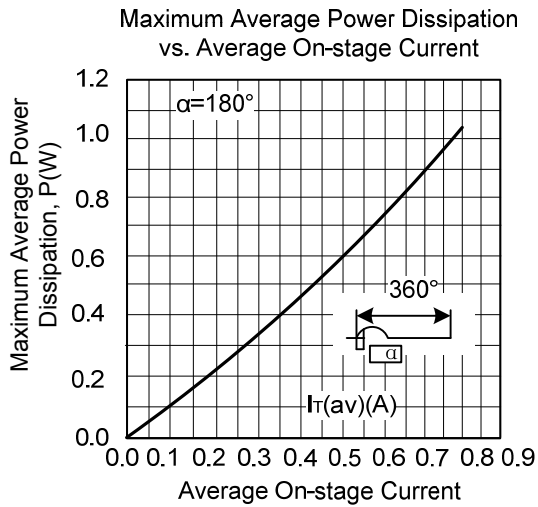

(Device Mounted On FR4 with Recommended Pad Layout)

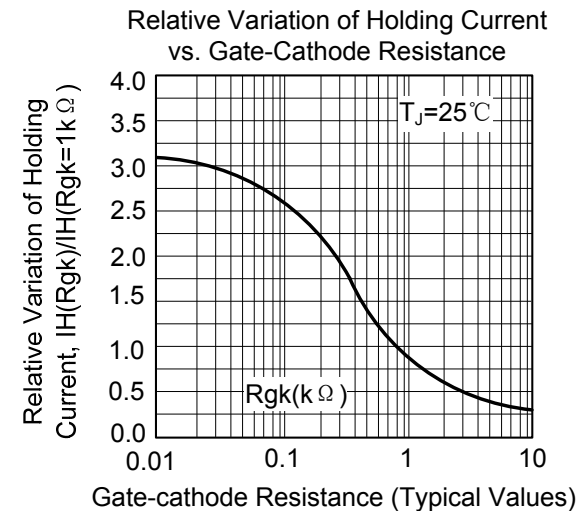
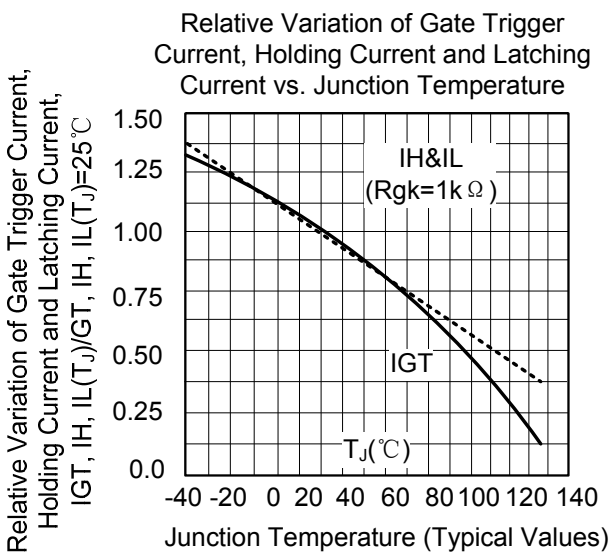

■ TYPICAL CHARACTERISTICS(Cont.)

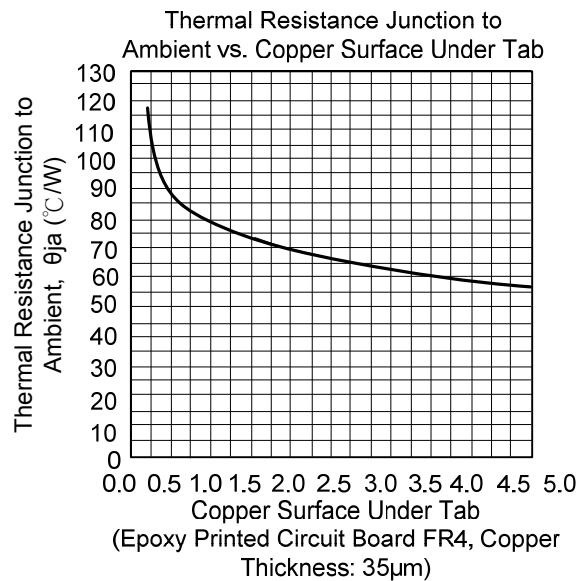
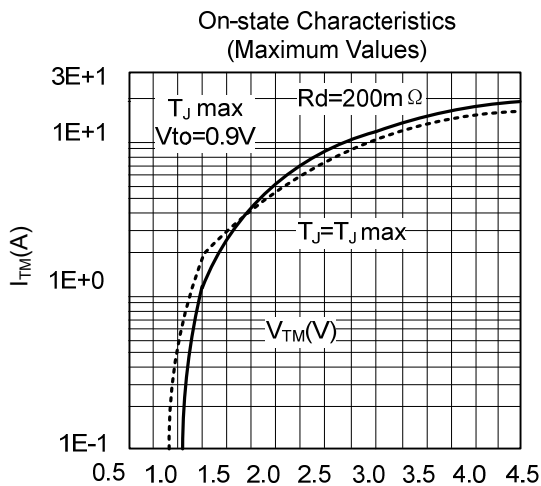
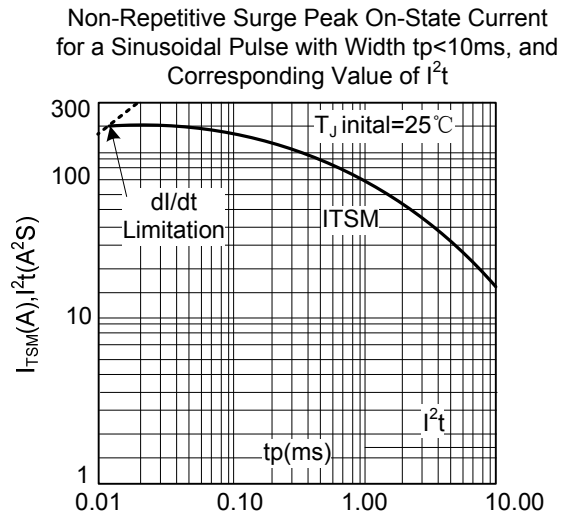
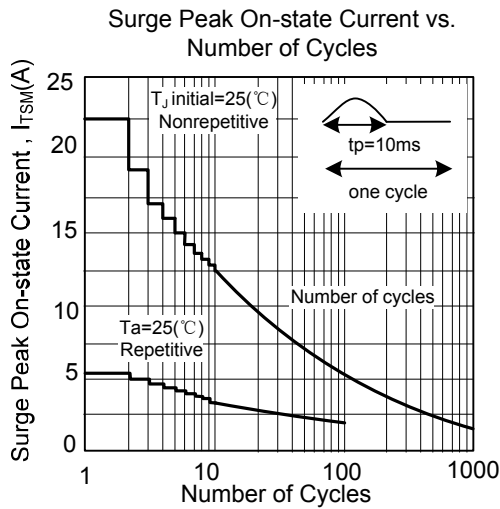
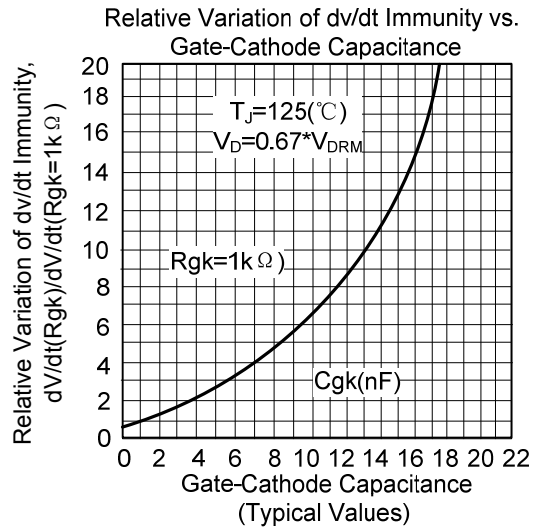
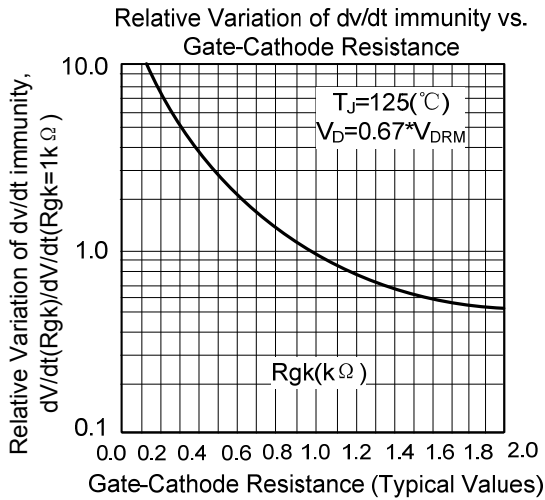

UTC assumes no responsibility for equipment failures that result from using products at values that exceed, even momentarily, rated values (such as maximum ratings, operating condition ranges, or other parameters) listed in products specifications of any and all UTC products described or contained herein. UTC products are not designed for use in life support appliances, devices or systems where malfunction of these products can be reasonably expected to result in personal injury. Reproduction in whole or in part is prohibited without the prior written consent of the copyright owner. The information presented in this document does not form part of any quotation or contract, is believed to be accurate and reliable and may be changed without notice.