

Z30-11B THRU Z30-330B

List

List..... 1

Package outline..... 2

Features..... 2

Mechanical data..... 2

Maximum ratings2

Electrical characteristics.....3

Rating and characteristic curves..... 4

Pinning information.....5

Taping & bulk specifications for AXIAL devices..... 5

Suggested thermal profiles for soldering processes..... 6

High reliability test capabilities.....7

Z30-11B THRU Z30-330B**3.0W Axial Lead Zener
Diodes - 11V - 330V****Features**

- Power dissipation up to 3.0W..
- Glass passivated chip struction.
- Wide zener reverse voltage range 11V to 330V.
- Standard zener voltage tolerance $\pm 5\%$ with a "B" suffix.
- Low zener impedance.
- Lead-free parts meet environmental standards of MIL-STD-19500 /228
- Suffix "-H" indicates Halogen-free part, ex.Z30-11B-H.

Mechanical data

- Epoxy : UL94-V0 rated flame retardant
- Case : Molded plastic, DO-41
- Terminals :Plated terminals, solderable per MIL-STD-750, Method 2026
- Polarity : Indicated by cathode band
- Mounting Position : Any
- Weight : Approximated 0.33 gram

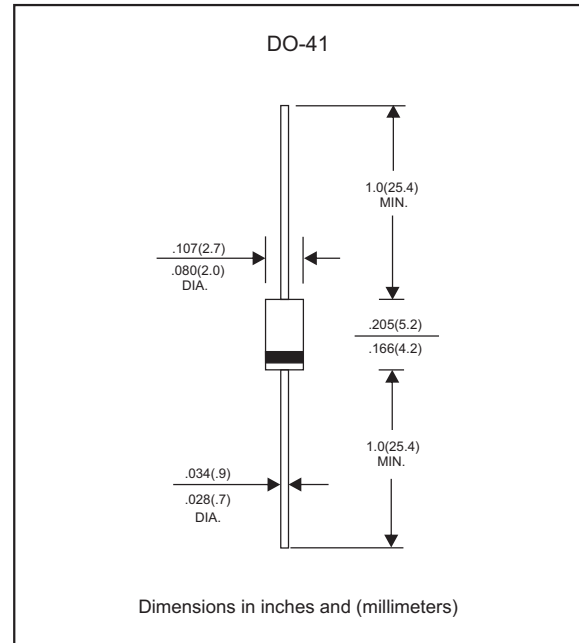
Package outline**MAXIMUM RATINGS** (at $T_A=25^\circ\text{C}$ unless otherwise noted)

PARAMETER	CONDITIONS	Symbol	MIN.	TYP.	MAX.	UNIT
Forward voltage	$I_F = 200 \text{ mA}$	V_F			1.20	V
Power Dissipation	$T_L = 75^\circ\text{C}$	P_D			3.0	W
Operating temperature		T_J	-55		+150	$^\circ\text{C}$
Storage temperature		T_{STG}	-65		+175	$^\circ\text{C}$

Electrical characteristics (at T_A=25°C unless otherwise noted)

Part No.	Marking code	Zener voltage			Test current	Zener impedance			Leakage current	
		V _Z @ I _{ZT} (Volts)				I _{ZT}	Z _{ZT} @ I _{ZT}	Z _{ZK} @ I _{ZK}	I _{ZK}	I _R
		Min.	Nom.	Max.	mA	(Ω)Max	(Ω)Max	mA	(uA)Max	Volts
Z30-11B	Z30-11B	10.45	11	11.55	68	4.0	700	0.25	1.0	8.4
Z30-12B	Z30-12B	11.40	12	12.60	63	4.5	700	0.25	1.0	9.1
Z30-13B	Z30-13B	12.35	13	13.65	58	4.5	700	0.25	0.5	9.9
Z30-15B	Z30-15B	14.25	15	15.75	50	5.5	700	0.25	0.5	11.4
Z30-16B	Z30-16B	15.20	16	16.80	47	5.5	700	0.25	0.5	12.2
Z30-18B	Z30-18B	17.10	18	18.90	42	6.0	750	0.25	0.5	13.7
Z30-20B	Z30-20B	19.00	20	21.00	37	7.0	750	0.25	0.5	15.2
Z30-22B	Z30-22B	20.90	22	23.10	34	8.0	750	0.25	0.5	16.7
Z30-24B	Z30-24B	22.80	24	25.20	31	9.0	750	0.25	0.5	18.2
Z30-27B	Z30-27B	25.65	27	28.35	28	10.0	750	0.25	0.5	20.6
Z30-30B	Z30-30B	28.50	30	31.50	25	16.0	1000	0.25	0.5	22.5
Z30-33B	Z30-33B	31.35	33	34.65	23	20.0	1000	0.25	0.5	25.1
Z30-36B	Z30-36B	34.20	36	37.80	21	22.0	1000	0.25	0.5	27.4
Z30-39B	Z30-39B	37.05	39	40.95	19	28.0	1500	0.25	0.5	29.7
Z30-43B	Z30-43B	40.85	43	45.15	17	33.0	1500	0.25	0.5	32.7
Z30-47B	Z30-47B	44.65	47	49.35	16	38.0	1500	0.25	0.5	35.8
Z30-51B	Z30-51B	48.45	51	53.55	15	45.0	1500	0.25	0.5	38.8
Z30-56B	Z30-56B	53.20	56	58.80	13	50.0	2000	0.25	0.5	42.6
Z30-62B	Z30-62B	58.90	62	65.10	12	55.0	2000	0.25	0.5	47.1
Z30-68B	Z30-68B	64.60	68	71.40	11	70.0	2000	0.25	0.5	51.7
Z30-75B	Z30-75B	71.25	75	78.75	10	85.0	2000	0.25	0.5	56.0
Z30-82B	Z30-82B	77.90	82	86.10	9.1	95.0	3000	0.25	0.5	62.2
Z30-91B	Z30-91B	86.45	91	95.55	8.2	115	3000	0.25	0.5	69.2
Z30-100B	Z30-100B	95.00	100	105.0	5	750	5000	0.25	0.5	75
Z30-110B	Z30-110B	104.5	110	115.5	5	750	5000	0.25	0.5	80
Z30-115B	Z30-115B	109.3	115	120.8	5	750	5000	0.25	0.5	85
Z30-120B	Z30-120B	114.0	120	126.0	5	850	5000	0.25	0.5	90
Z30-130B	Z30-130B	123.5	130	136.5	5	1000	5000	0.25	0.5	95
Z30-140B	Z30-140B	133.0	140	147.0	5	1200	5000	0.25	0.5	105
Z30-150B	Z30-150B	142.5	150	157.5	5	1300	5000	0.25	0.5	110
Z30-160B	Z30-160B	152.0	160	168.0	5	1500	5000	0.25	0.5	120
Z30-170B	Z30-170B	161.5	170	178.5	5	2200	5000	0.25	0.5	130
Z30-180B	Z30-180B	171.0	180	189.0	5	2200	5000	0.25	0.5	140
Z30-190B	Z30-190B	180.5	190	199.5	5	2500	5000	0.25	0.5	150
Z30-200B	Z30-200B	190.0	200	210.0	5	2500	8000	0.25	0.5	165
Z30-210B	Z30-210B	199.5	210	220.5	5	5000	9000	0.25	0.5	165
Z30-220B	Z30-220B	209.0	220	231.0	5	5000	9000	0.25	0.5	170
Z30-230B	Z30-230B	218.5	230	241.5	5	5000	9000	0.25	0.5	175
Z30-240B	Z30-240B	228.0	240	252.0	5	5000	9000	0.25	0.5	180
Z30-250B	Z30-250B	237.5	250	262.5	5	5000	9000	0.25	0.5	190
Z30-260B	Z30-260B	247.0	260	273.0	5	5000	9000	0.25	0.5	195
Z30-270B	Z30-270B	256.5	270	283.5	5	5000	9000	0.25	0.5	200
Z30-280B	Z30-280B	266.0	280	294.0	5	5000	9000	0.25	0.5	210
Z30-290B	Z30-290B	275.5	290	304.5	5	5000	9000	0.25	0.5	215
Z30-300B	Z30-300B	285.0	300	315.0	5	5000	9000	0.25	0.5	220
Z30-310B	Z30-310B	294.5	310	325.5	5	5000	9500	0.25	0.5	225
Z30-320B	Z30-320B	304.0	320	336.0	5	5000	9500	0.25	0.5	233
Z30-330B	Z30-330B	313.5	330	346.5	5	5000	9500	0.25	0.5	240

Note : 5% tolerance of Zener voltage



Rating and characteristic curves (Z30-11B THRU Z30-330B)

FIG. 1-MAXIMUM CONTINUOUS POWER DISSIPATION

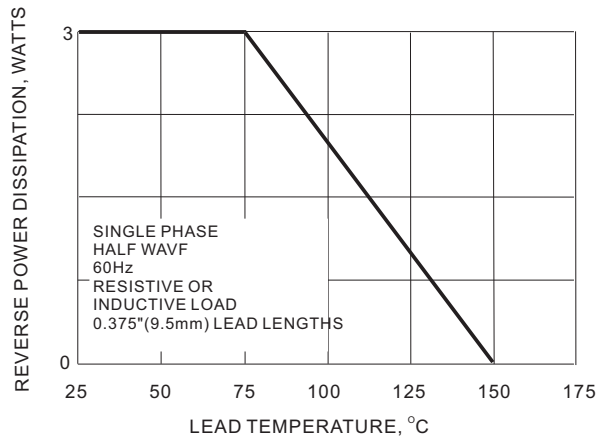

FIG. 2-ZENER VOLTAGE VERSUS ZENER CURRENT

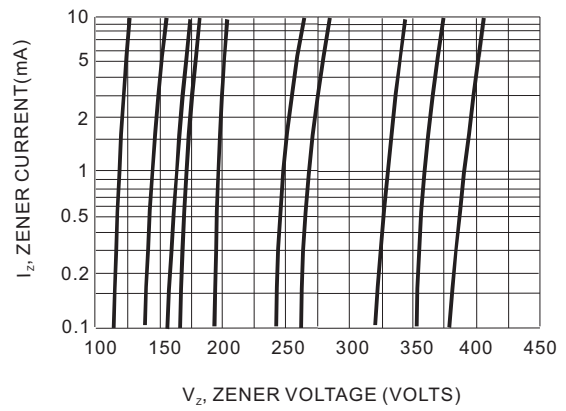

FIG. 3-TYPICAL INSTANTANEOUS FORWARD CHARACTERISTICS

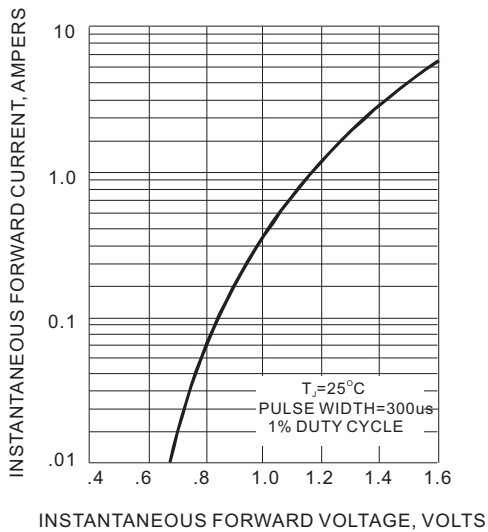

FIG. 4-TYPICAL REVERSE CHARACTERISTICS

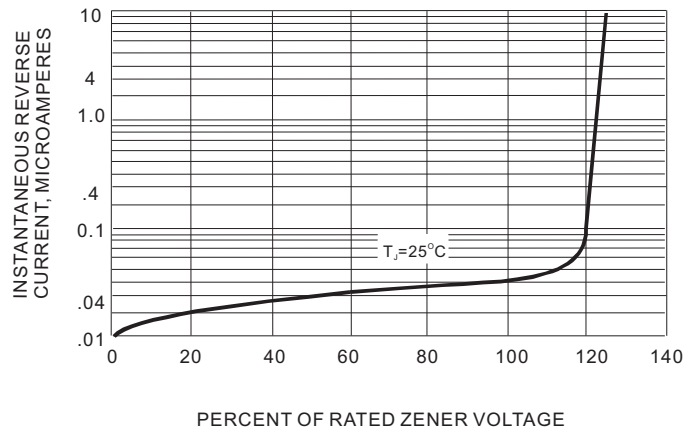
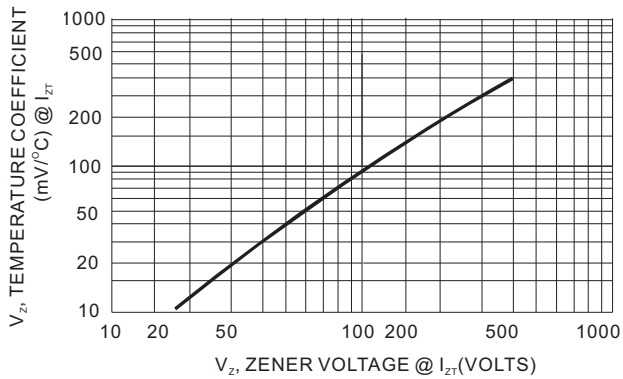



FIG. 5-TYPICAL TEMPERATURE COEFFICIENTS



Z30-11B THRU Z30-330B

Pinning information

Pin	Simplified outline	Symbol
Pin1 cathode Pin2 anode		

Taping & bulk specifications for AXIAL devices

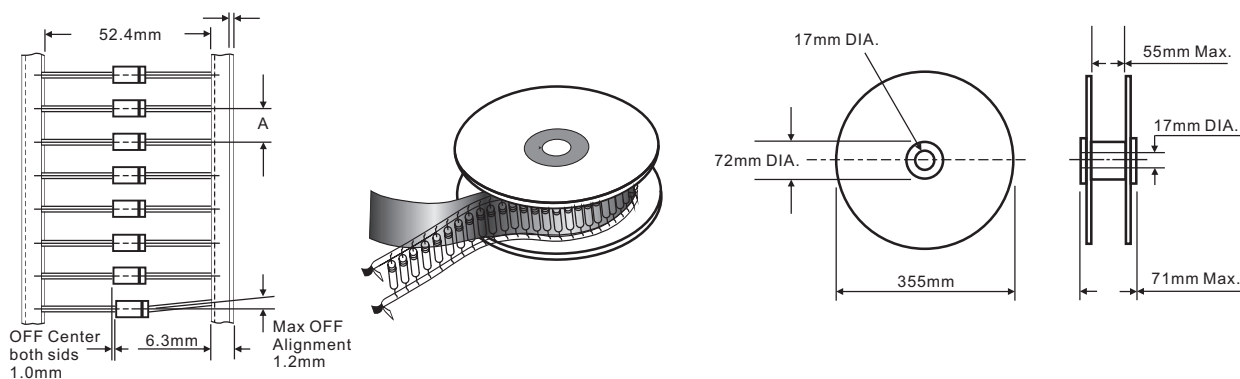

REEL PACKING

DEVICE CASE TYPE	Q'TY 1 (PCS / REEL)	COMPONENT SPACING "A" in FIG. A	CARTON SIZE (m/m)	Q'TY 2 (PCS / CARTON)	APPROX. CROSS WEIGHT(kg)
DO-41	5,000	5 mm	360 * 340 * 370	20,000	10.8

AMMO PACKING

DEVICE CASE TYPE	Q'TY 1 (PCS / BOX)	INNER BOX SIZE (m/m)	CARTON SIZE (m/m)	Q'TY 2 (PCS / CARTON)	APPROX. CROSS WEIGHT(kg)
DO-41	5,000	260 * 83 * 160	440 * 270 * 340	50,000	20.0

Z30-11B THRU Z30-330B

BULK PACKING

DEVICE CASE TYPE	Q'TY 1 (PCS / BOX)	INNER BOX SIZE (m/m)	CARTON SIZE (m/m)	Q'TY 2 (PCS / CARTON)	APPROX. CROSS WEIGHT(kg)
DO-41	1,000	194 * 84 * 20	465 * 220 * 260	50,000	20.6

Suggested thermal profiles for soldering processes

1. Lead free temperature profile wave-soldering

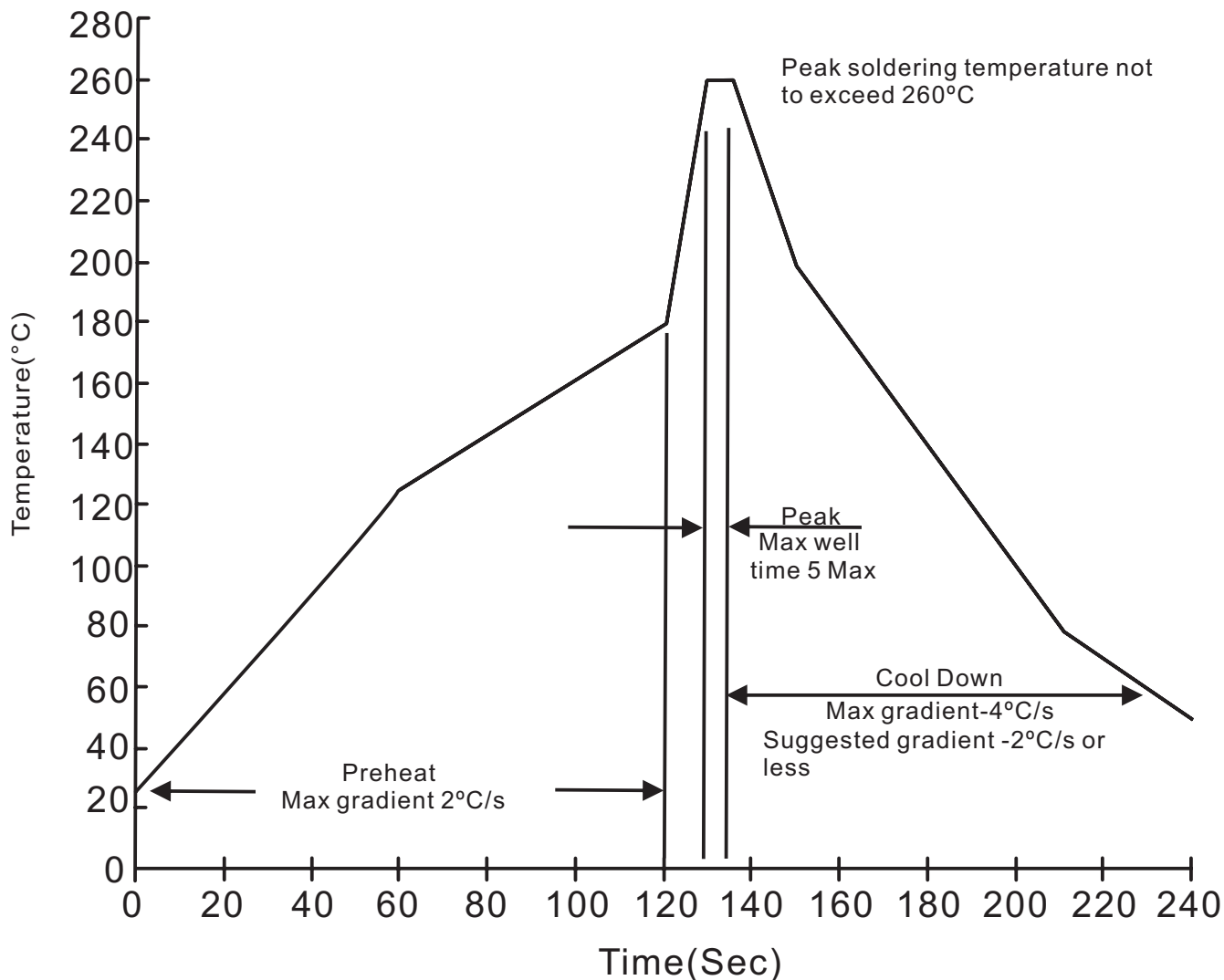

Z30-11B THRU Z30-330B**High reliability test capabilities**

Item Test	Conditions	Reference
1. Solder Resistance	at 260±5°C for 10±2sec. immerse body into solder 1/16"±1/32"	MIL-STD-750D METHOD-2031
2. Solderability	at 245±5°C for 5 sec.	MIL-STD-202F METHOD-208
3. Pull Test	1kg in axial lead direction for 10 sec.	MIL-STD-750D METHOD-2036
4. Bend Lead	1kg weight applied to each lead bending arc 90°±5° for 3 times.	MIL-STD-750D METHOD-2036
5. High Temperature Reverse Bias	$V_R=80\%$ rate at $T_J=150^\circ\text{C}$ for 168 hrs.	MIL-STD-750D METHOD-1038
6. Pressure Cooker	15P _{SIG} at $T_A=121^\circ\text{C}$ for 4 hrs.	JESD22-A102
7. Temperature Cycling	-55°C to +125°C dwelled for 30 min. and transferred for 5min. total 10 cycles.	MIL-STD-750D METHOD-1051
8. Thermal Shock	0°C for 5 min. rise to 100°C for 5 min. total 10 cycles.	MIL-STD-750D METHOD-1056
9. Humidity	at $T_A=85^\circ\text{C}$, RH=85% for 1000hrs.	MIL-STD-750D METHOD-1021
10. High Temperature Storage Life	at 175°C for 1000 hrs.	MIL-STD-750D METHOD-1031