



## UP2003

Power MOSFET

### P-CHANNEL LOGIC LEVEL ENHANCEMENT MODE FIELD EFFECT TRANSISTOR

#### DESCRIPTION

The **UP2003** uses advanced trench technology to provide excellent  $R_{DS(ON)}$ , low gate charge and operation with low gate voltages. This device is suitable for use as a load switch or in PWM applications.

#### FEATURES

- \*  $V_{DS}(V)=-25V$
- \*  $I_D=-9 A$
- \*  $R_{DS(ON)}<35 m\Omega @ V_{GS}=-4.5 V, I_D=-7 A$
- \*  $R_{DS(ON)}<20 m\Omega @ V_{GS}=-10 V, I_D=-9 A$

#### SYMBOL

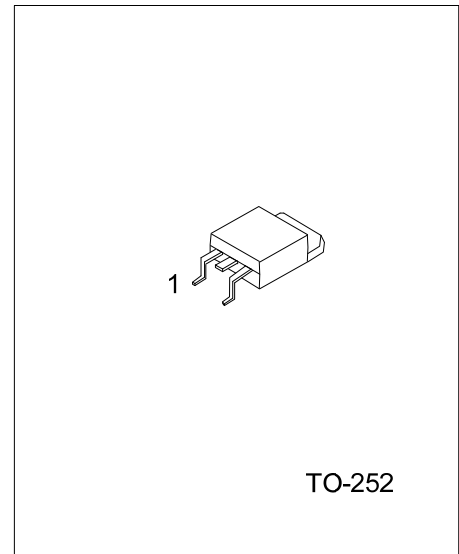
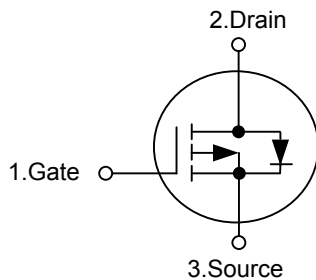

\*Pb-free plating product number: UP2003L

#### ORDERING INFORMATION

Ordering Number		Package	Pin Assignment			Packing
Normal	Lead Free Plating		1	2	3	
UP2003-TN3-R	UP2003L-TN3-R	TO-252	G	D	S	Tape Reel
UP2003-TN3-T	UP2003L-TN3-T	TO-252	G	D	S	Tube

<p>UP2003L-TN3-R</p> <p>(1)Packing Type</p> <p>(2)Package Type</p> <p>(3)Lead Plating</p>	<p>(1) R: Tape Reel, T: Tube</p> <p>(2) TN3:TO-252</p> <p>(3) L: Lead Free Plating, Blank: Pb/Sn</p>
---	--

■ ABSOLUTE MAXIMUM RATINGS ( $T_C = 25^\circ\text{C}$ , unless otherwise specified)

PARAMETER	SYMBOL	RATINGS	UNIT
Gate Source voltage	$V_{GS}$	$\pm 20$	V
Continuous Drain Current	$I_D$	-9	A
Pulsed Drain Current (Note 1)	$I_{DM}$	-50	
Power Dissipation	$P_D$	2.5	W
Junction Temperature	$T_J$	+150	$^\circ\text{C}$
Storage Temperature	$T_{STG}$	-55 ~ +150	

Note: Absolute maximum ratings are those values beyond which the device could be permanently damaged.  
 Absolute maximum ratings are stress ratings only and functional device operation is not implied.

■ THERMAL DATA

PARAMETER	SYMBOL	MIN	TYP	MAX	UNIT
Junction-to-Ambient	$\theta_{JA}$			50	$^\circ\text{C/W}$
Junction-to-Case	$\theta_{JC}$			25	$^\circ\text{C/W}$

■ ELECTRICAL CHARACTERISTICS ( $T_C = 25^\circ\text{C}$ , unless otherwise specified)

PARAMETER	SYMBOL	TEST CONDITIONS	MIN	TYP	MAX	UNIT
<b>OFF CHARACTERISTICS</b>						
Drain-Source Breakdown Voltage	$BV_{DSS}$	$V_{GS} = 0\text{ V}, I_D = -250\mu\text{A}$	-25			V
Drain Source Leakage Current	$I_{DSS}$	$V_{DS} = -24\text{ V}, V_{GS} = 0\text{ V}$			-1	$\mu\text{A}$
		$V_{DS} = -20\text{ V}, V_{GS} = 0\text{ V}$			-10	
Gate-Body Leakage Current	$I_{GSS}$	$V_{DS} = 0\text{ V}, V_{GS} = \pm 20\text{ V}$			$\pm 100$	nA
<b>ON CHARACTERISTICS</b>						
Gate-Threshold Voltage	$V_{GS(TH)}$	$V_{DS} = V_{GS}, I_D = -250\mu\text{A}$	-1.0	-1.5	-3.0	V
On-State Drain Current (Note 2)	$I_{D(ON)}$	$V_{DS} = -5\text{ V}, V_{GS} = -10\text{ V}$	-50			A
Drain-Source On-Resistance (Note 2)	$R_{DS(ON)}$	$V_{GS} = -4.5\text{ V}, I_D = -7\text{ A}$		25	35	m $\Omega$
		$V_{GS} = -10\text{ V}, I_D = -9\text{ A}$		15	20	
<b>DYNAMIC PARAMETERS</b>						
Input Capacitance	$C_{ISS}$	$V_{DS} = -15\text{ V}, V_{GS} = 0\text{ V}, f = 1\text{ MHz}$		1610		pF
Output Capacitance	$C_{OSS}$			410		
Reverse Transfer Capacitance	$C_{RSS}$			200		
<b>SWITCHING PARAMETERS (Note 3)</b>						
Gate to Source Charge	$Q_G$	$V_{DS} = -0.5V_{(BR)DSS}, V_{GS} = -10\text{ V}, I_D = -9\text{ A}$		17	24	nC
Gate Charge at Threshold	$Q_{GS}$			5		
Gate to Drain Charge	$Q_{GD}$			6		
Turn-ON Delay Time	$t_{D(ON)}$	$V_{DS} = -15\text{ V}, I_D \approx -1\text{ A}, V_{GS} = -10\text{ V}, R_{GS} = 6\Omega, R_L = 1\Omega$		6.2	9.3	ns
Turn-ON Rise Time	$t_R$			10		
Turn-OFF Delay Time	$t_{D(OFF)}$			18		
Turn-ON Delay Time	$t_{D(ON)}$			10		
Turn-OFF Fall-Time	$t_F$			5		
<b>SOURCE- DRAIN DIODE RATINGS AND CHARACTERISTICS</b>						
Diode Continuous Forward Current	$I_S$				-2.1	A
Diode Pulse Current (Note 1)	$I_{SM}$				-4	
Forward Voltage (Note 2)	$V_{SD}$	$I_F = I_S, V_{GS} = 0\text{ V}$			-1.2	V

Note: 1. Pulse width limited by maximum junction temperature.  
 2. Pulse test: Pulse Width  $\leq 300\mu\text{sec}$ , Duty Cycle  $\leq 2\%$   
 3. Independent of operating temperature.

## TYPICAL CHARACTERISTICS

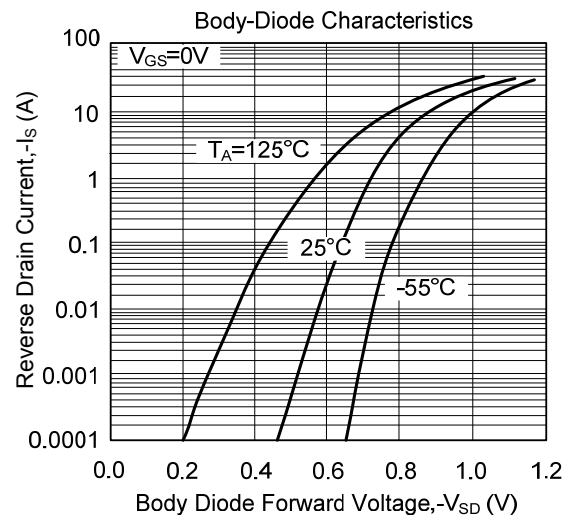
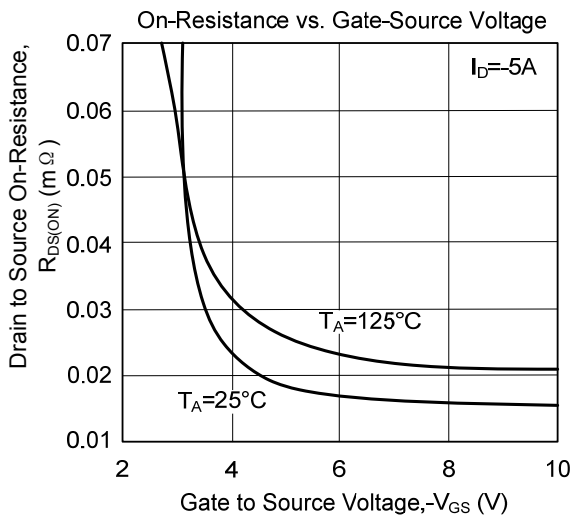
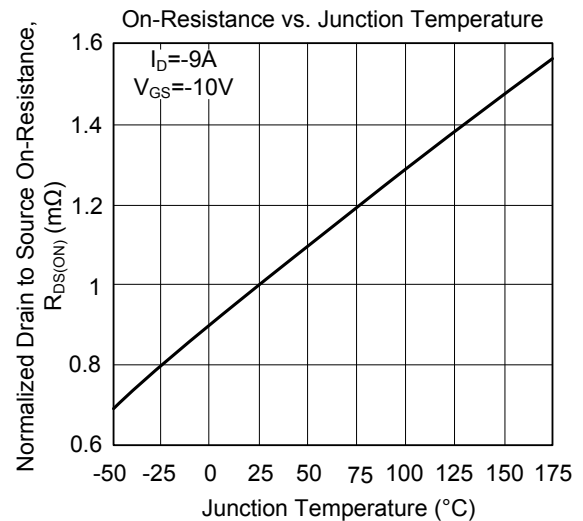
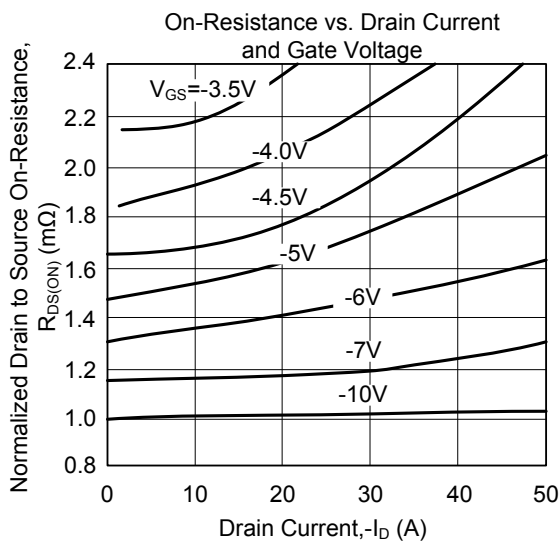
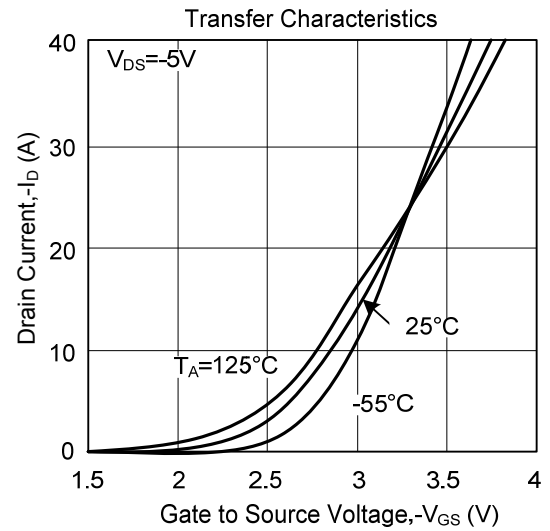
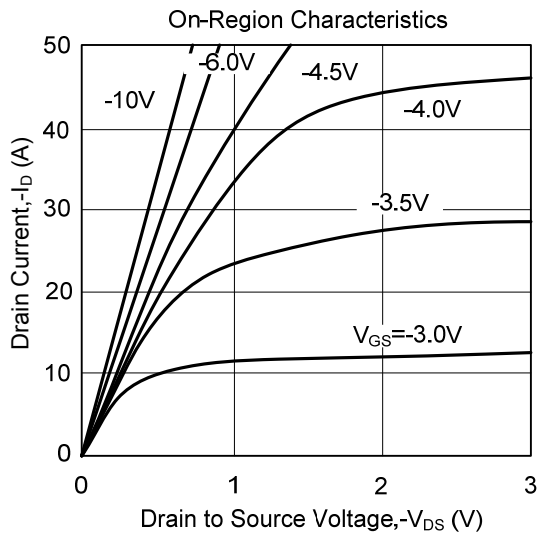

■ TYPICAL CHARACTERISTICS(Cont.)

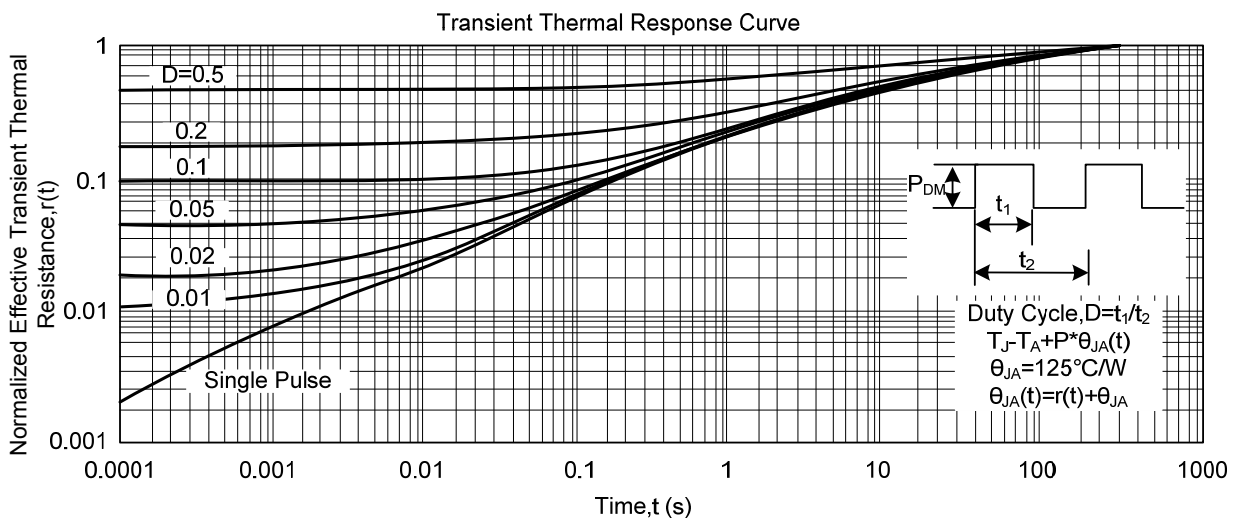
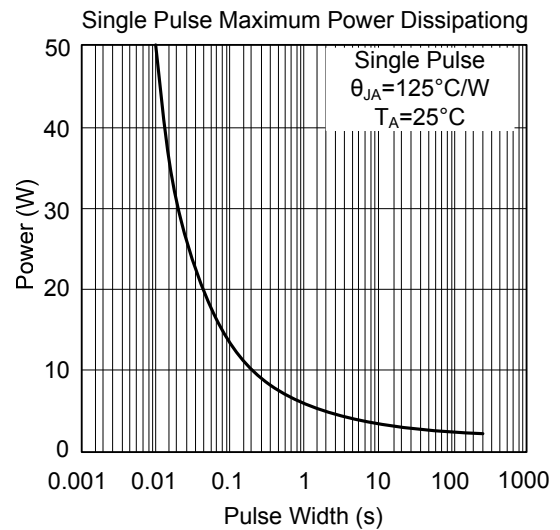
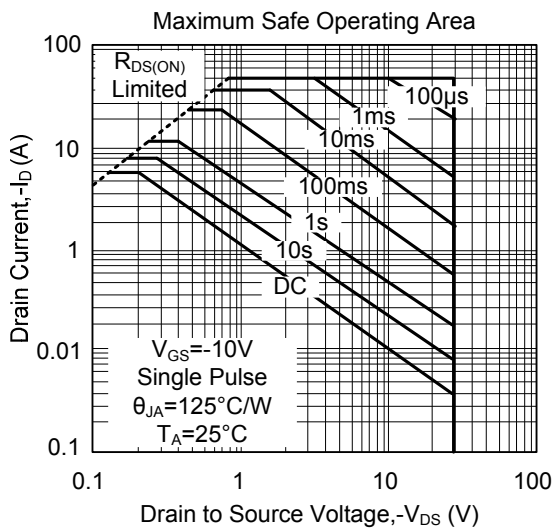
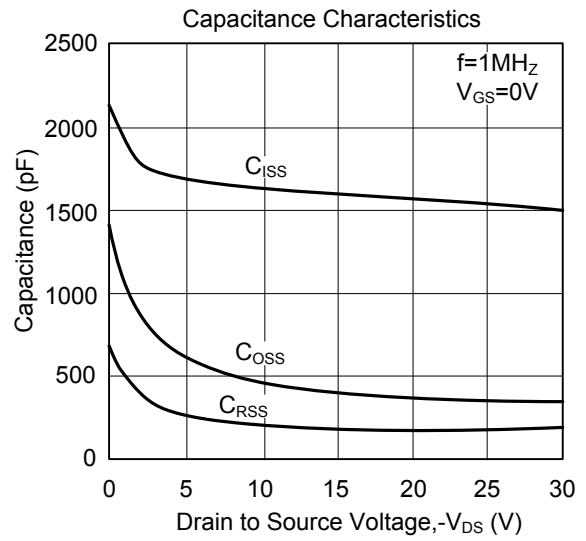
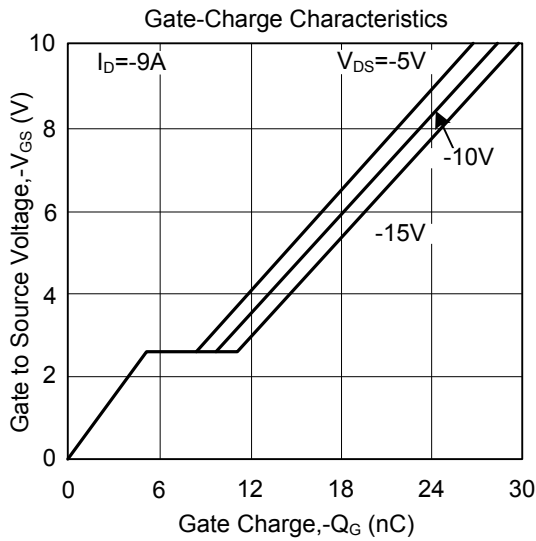

UTC assumes no responsibility for equipment failures that result from using products at values that exceed, even momentarily, rated values (such as maximum ratings, operating condition ranges, or other parameters) listed in products specifications of any and all UTC products described or contained herein. UTC products are not designed for use in life support appliances, devices or systems where malfunction of these products can be reasonably expected to result in personal injury. Reproduction in whole or in part is prohibited without the prior written consent of the copyright owner. The information presented in this document does not form part of any quotation or contract, is believed to be accurate and reliable and may be changed without notice.