

Toroidal Inductors

Medium Current

CTP4559

CTP4559 is a medium current inductor with the following data and features:

- **Core type:** 0.68" o.d., Moly-Permalloy Powder, perm 125.
 - **Power rating:** 0.86 watts for temp. rise 50°C.
 - **Typical applications:** Switching Inductors in Switch Mode Power Supplies.
- Four mounting styles are offered:**
- 1 Flying leads (1.00"), for vertical or horizontal mounting.
 - 2 4-pin header, for vertical mounting.
 - 3 Threaded center hole, flying leads (2.00").
 - 4 2-pin header, for vertical mounting.



MECHANICAL

Style 1

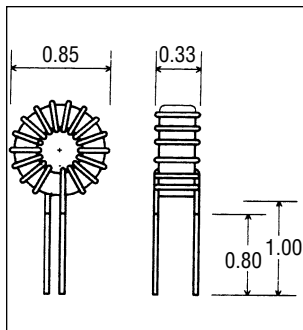

Style 2

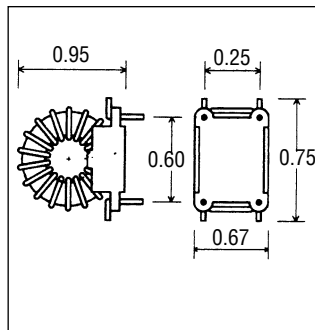

Style 3

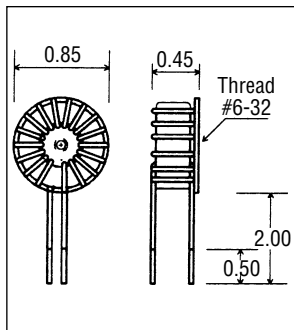

Style 4

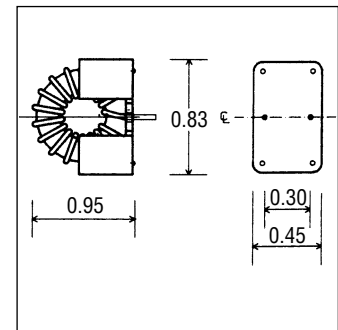

ELECTRICAL SPECIFICATION

Ordering Information: Substitute the style number for the asterisk (*). Example: CTP4559, Style 1, 56uH. Order: CTP4559 - 116

Part No. CTP4559 -	Ind. (uH)	DCR Ohms	Rated Current Amp. RMS	I (amp.) @ Lsat. 10%	I (amp.) @ Lsat. 25%	I (amp.) @ Lsat. 50%
* 01	3.3	0.005	13.5	9.7	14.5	24.2
* 02	3.9	0.005	13.0	8.9	13.3	22.2
* 03	4.7	0.006	12.5	8.1	12.1	20.2
* 04	5.6	0.006	12.0	7.4	11.1	18.5
* 05	6.8	0.008	10.2	6.7	10.1	16.8
* 06	8.2	0.009	9.7	6.1	9.2	15.3
* 07	10	0.010	9.3	5.6	8.3	13.9
* 08	12	0.011	8.9	5.1	7.6	12.7
* 09	15	0.015	7.5	4.5	6.8	11.3
* 10	18	0.017	7.2	4.1	6.2	10.3
* 11	22	0.018	6.8	3.7	5.6	9.4
* 12	27	0.020	6.5	3.4	5.1	8.4
* 13	33	0.022	6.2	3.1	4.6	7.6
* 14	39	0.024	6.0	2.8	4.2	7.0
* 15	47	0.027	5.7	2.6	3.8	6.4
* 16	56	0.029	5.5	2.3	3.5	5.9

Part No. CTP4559 -	Ind. (uH)	DCR Ohms	Rated Current Amp. RMS	I (amp.) @ Lsat. 10%	I (amp.) @ Lsat. 25%	I (amp.) @ Lsat. 50%
* 17	68	0.032	5.2	2.1	3.2	5.3
* 18	82	0.035	5.0	1.9	2.9	4.8
* 19	100	0.038	4.7	1.8	2.6	4.4
* 20	120	0.053	4.0	1.6	2.4	4.0
* 21	150	0.074	3.4	1.4	2.1	3.6
* 22	180	0.103	2.9	1.3	2.0	3.3
* 23	220	0.113	2.8	1.2	1.8	3.0
* 24	270	0.159	2.3	1.1	1.6	2.7
* 25	330	0.219	2.0	1.0	1.4	2.4
* 26	390	0.303	1.7	0.9	1.3	2.2
* 27	470	0.332	1.6	0.8	1.2	2.0
* 28	560	0.362	1.5	0.7	1.1	1.9

CTP4559