



### Features

- 500MHz to 2500MHz Operation
- 6-Bit Digital Step Attenuator
- Parallel Control Interface
- 31.5 dB Attenuation Range (0.5dB Step)
- High OIP3/P1dB= +43/25 dBm
- Gain=-20dB to +11.5dB at 2017 MHz
- Single +5V Supply
- Footprint Compatible with 32-Pin 5mmx5mm QFN

### Applications

- Cellular, PCS, 3G Infrastructure
- WiBro, WiMax, LTE
- High Linearity Power Control

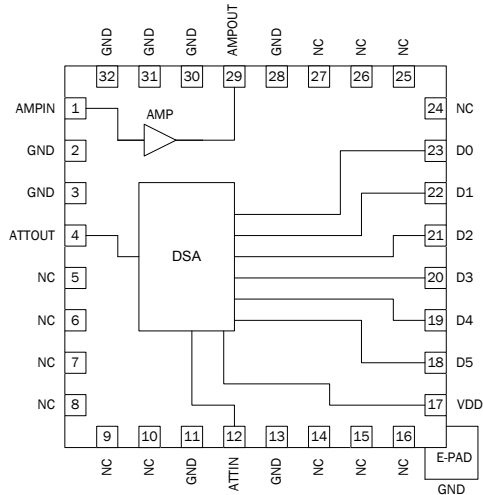

Functional Block Diagram

### Product Description

RFMD's RFDA2015 is a digital controlled variable gain amplifier featuring high linearity over the entire gain control range. The 6-bit digital step attenuator is programmed with a parallel mode control interface. The RFDA2015 is packaged in a small 5.2mmx5.2mm leadless laminate MCM with plated through thermal vias for ultra low thermal resistance. The footprint for this module is directly compatible with most 32-pin 5mmx5mm QFNs. The output amplifier is externally matched, allowing for optimum performance over specific bands within 500MHz to 2500MHz.

### Ordering Information

RFDA2015SQ	Sample bag with 25 pieces
RFDA2015SR	7" Reel with 100 pieces
RFDA2015TR7	7" Reel with 750 pieces
RFDA2015TR13	13" Reel with 2500 pieces
RFDA2015PCK-410	1800 MHz to 2200 MHz PCBA with 5-piece sample bag

### Optimum Technology Matching® Applied

- |  |                                      |  |                                   |
|--|--------------------------------------|--|-----------------------------------|
| <input checked="" type="checkbox"/> GaAs HBT | <input type="checkbox"/> SiGe BiCMOS | <input checked="" type="checkbox"/> GaAs pHEMT | <input type="checkbox"/> GaN HEMT |
| <input type="checkbox"/> GaAs MESFET         | <input type="checkbox"/> Si BiCMOS   | <input type="checkbox"/> Si CMOS               | <input type="checkbox"/> RF MEMS  |
| <input type="checkbox"/> InGaP HBT           | <input type="checkbox"/> SiGe HBT    | <input type="checkbox"/> Si BJT                | <input type="checkbox"/> LDMOS    |

## Absolute Maximum Ratings

Parameter	Rating	Unit
Supply Voltage ( $V_{CC}$ , $V_{DD}$ )	5.5	V
Collector Current ( $I_C$ )	200	mA
Power Dissipation <sup>1</sup> ( $P_{DISS}$ )	750	mW
RF Input Power	20	dBm
Operating Temperature ( $T_{CASE}$ )	-40 to +85	°C
Junction Temperature ( $T_J$ )	150	°C
Storage Temperature	-40 to +150	°C
ESD Rating (HBM)	Class 1B	
Moisture Sensitivity Level	MSL 3	



**Caution!** ESD sensitive device.

Exceeding any one or a combination of the Absolute Maximum Rating conditions may cause permanent damage to the device. Extended application of Absolute Maximum Rating conditions to the device may reduce device reliability. Specified typical performance or functional operation of the device under Absolute Maximum Rating conditions is not implied.

RoHS status based on EUDirective2002/95/EC (at time of this document revision).

The information in this publication is believed to be accurate and reliable. However, no responsibility is assumed by RF Micro Devices, Inc. ("RFMD") for its use, nor for any infringement of patents, or other rights of third parties, resulting from its use. No license is granted by implication or otherwise under any patent or patent rights of RFMD. RFMD reserves the right to change component circuitry, recommended application circuitry and specifications at any time without prior notice.

Notes:

$$1. P_{DISS} = V_{CC} * I_C - \text{RF Output Power} + \text{RF Input Power}$$

Parameter	Specification			Unit	Condition
	Min.	Typ.	Max.		
<b>Frequency Range</b>	500		2500	MHz	
Gain (Max Gain State)	10.0	11.5	13.0	dB	Attenuation = 0dB, 2017 MHz
Gain Control Range		31.5		dB	0.5 dB LSB, 6 bits
Step Accuracy	±(0.1 +5% attenuation setting)			dB	Major state max error
Output IP3	40	43		dBm	2017 MHz, $P_{OUT} = 5$ dBm/ tone, 1 MHz spacing
Output P1dB	23	25		dBm	Attenuation = 0dB, 2017 MHz
Input Return Loss		17		dB	2017 MHz
Output Return Loss		11		dB	2017 MHz
Noise Figure		7		dB	2017 MHz, Attenuation = 0dB
$t_{RISE}$ , $t_{FALL}$		200		ns	10/90% RF
Amplifier Supply Voltage ( $V_{CC}$ )	4.75	5.00	5.25	V	
Attenuator Supply Voltage ( $V_{DD}$ )	3.30	5.00	5.25	V	
Total Supply Current	90	115	135	mA	Sum of currents from $V_{DD}$ and $V_{CC}$
Thermal Resistance		87		°C/W	
Control Interface	6 Bit, Parallel				
Control Voltages	Low, $V_{CTL} = 0$ to $0.8 V_{DC}$ High, $V_{CTL} = 2.0$ to $V_{DD} V_{DC}$			V	
Notes:					
1. All measurements based on the 1800MHz to 2200MHz Application Circuit, $T = 25$ °C					
2. $V_{CC} = V_{DD} = +5V$ , $V_{CTL} = 0/5V$					

**Typical Performance - 1.8GHz to 2.2GHz Application Circuit Performance**

**Gain, Major States, 25 °C**

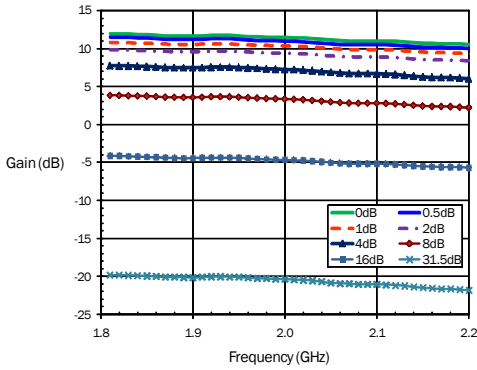

**S21 over Temperature, Max Gain**

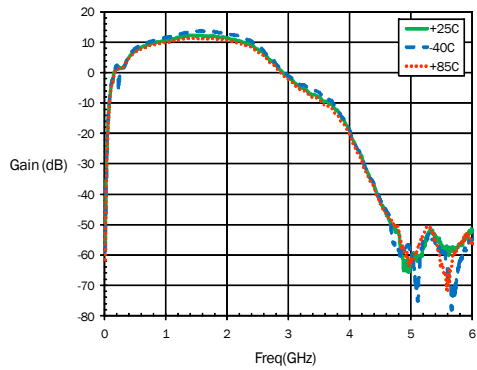

**Input RL, Major States, 25 °C**

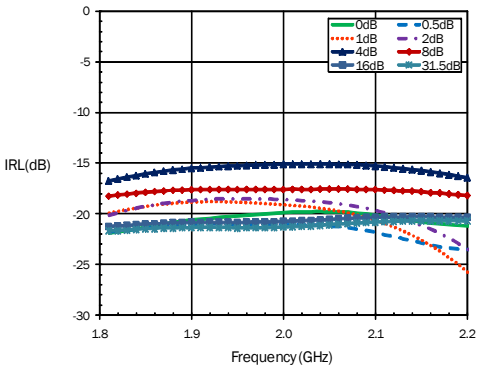

**Input Return Loss over Temperature, Max Gain**

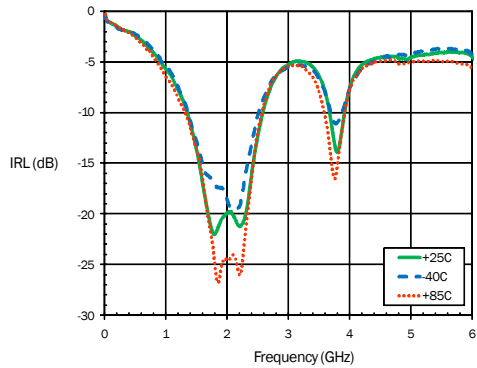

**Output RL, Major States, 25 °C**

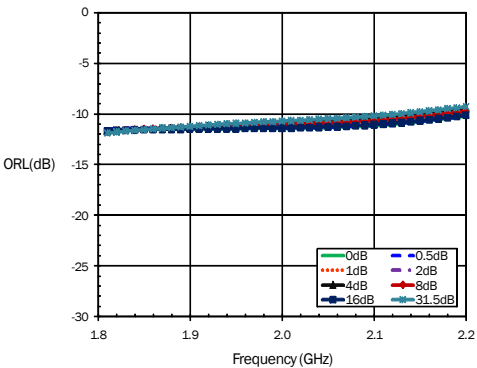

**Output Return Loss over Temperature, Max Gain**

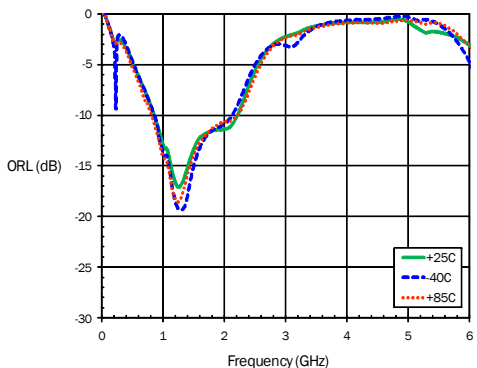

## Typical Performance - 1.8GHz to 2.2GHz Application Circuit Performance

Isolation, Major States, 25 °C

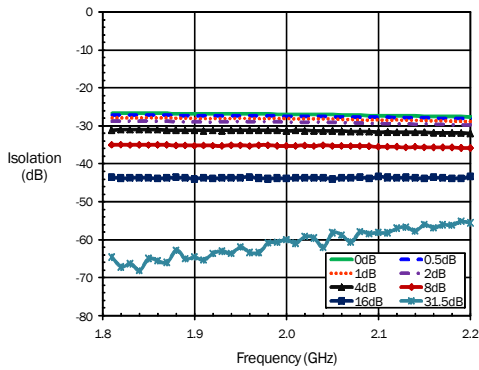

Isolation over Temperature, Max Gain

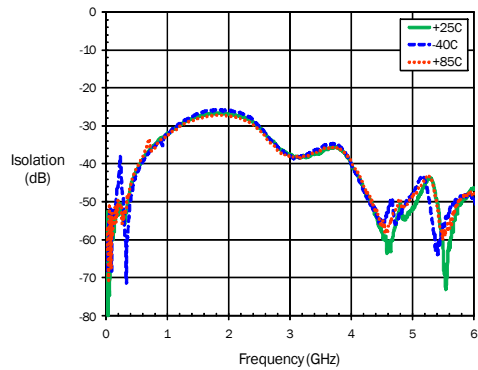

Attenuation Error, Major States, 25 °C

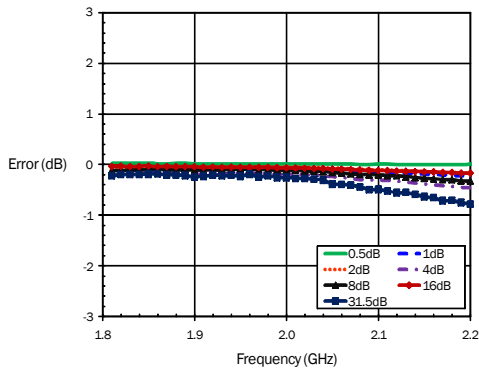

Attenuation Error, Major States, 85 °C

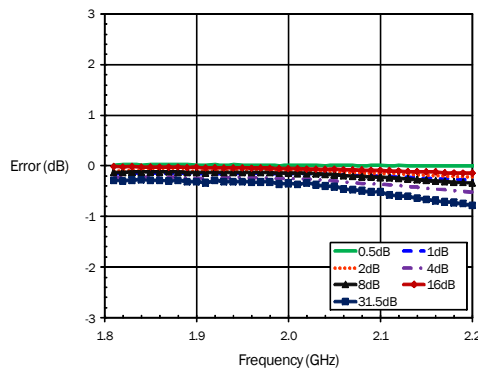

Attenuation Error, Major States, -40 °C

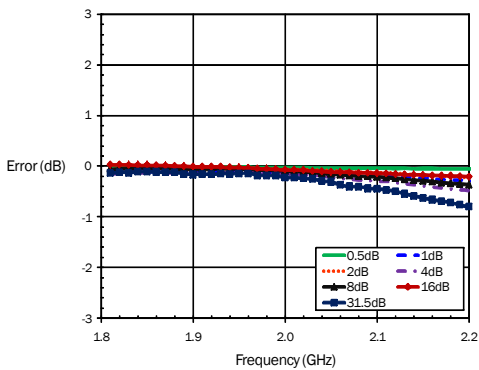

Normalized Phase Error, Major States, 25 °C

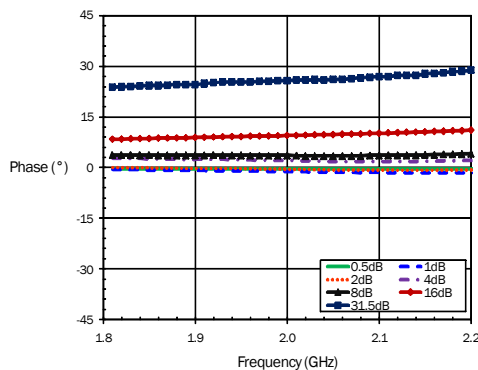

**Typical Performance: 1.8GHz to 2.2GHz Application Circuit Performance**

**Successive Step Error at 2020MHz**

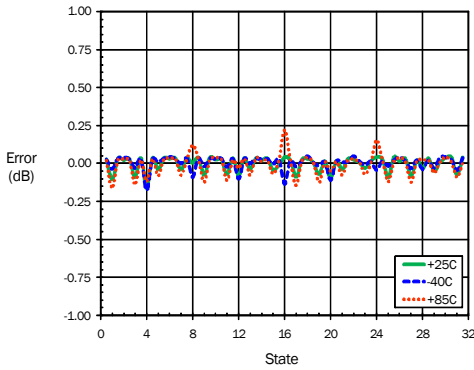

**Worst Case Successive Step Error, 25 °C**

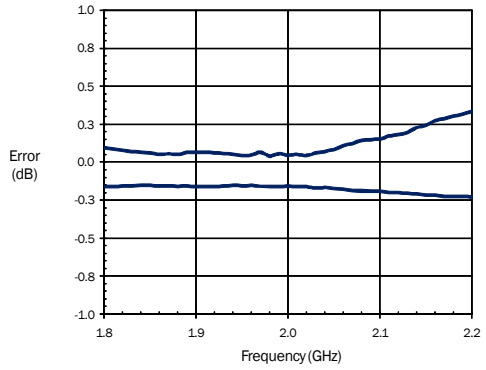

**OIP3 over Temperature, Max Gain**

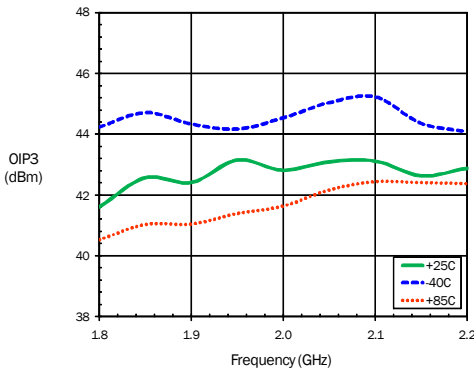

**OIP3, Major States, 25 °C**

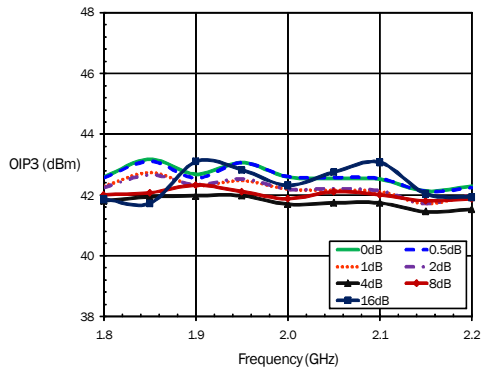

**P1dB over Temperature, Max Gain**

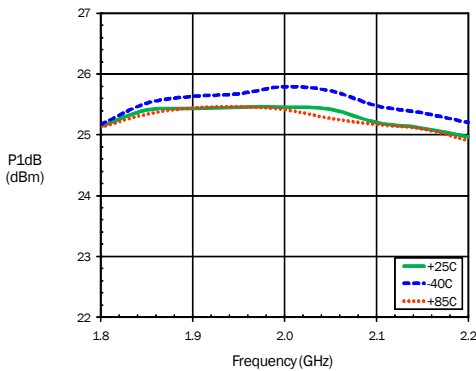

**ACPR over Temperature, Max Gain  
WCDMA, 64 DPCH, 2017MHz**

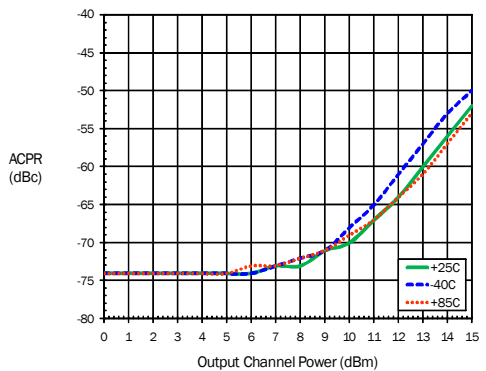

## Typical Performance - 1.8GHz to 2.2GHz Application Circuit Performance

Noise Figure over Temperature, Max Gain

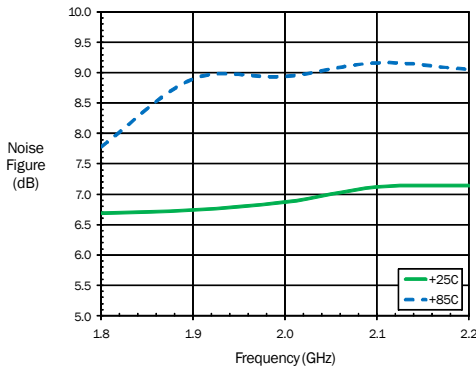

DCIV over Temperature, Max Gain

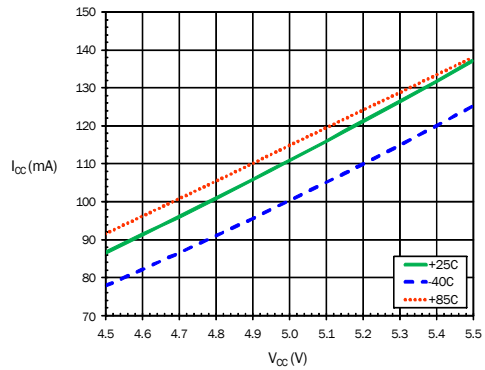

### Truth Table

Control Voltage Input						Relative Gain Setting
D5 16dB	D4 8dB	D3 4dB	D2 2dB	D1 1dB	D0 0.5dB	
1	1	1	1	1	1	Max Gain
1	1	1	1	1	0	-0.5dB
1	1	1	1	0	1	-1dB
1	1	1	0	1	1	-2dB
1	1	0	1	1	1	-4dB
1	0	1	1	1	1	-8dB
0	1	1	1	1	1	-16dB
0	0	0	0	0	0	-31.5dB

0=Low,  $V_{CTL}=0$  to  $0.8 V_{DC}$   
 1=High,  $V_{CTL}=2.0$  to  $V_{DD} V_{DC}$

Pin	Function	Description
1	<b>AMPIN</b>	Amplifier Input - DC Block Required.
2	<b>GND</b>	RF/DC Ground Connection.
3	<b>GND</b>	RF/DC Ground Connection.
4	<b>ATTOUT</b>	Digital Attenuator Output - DC Block Required.
5	<b>ACG1</b>	No Internal Connection.
6	<b>ACG2</b>	No Internal Connection.
7	<b>ACG3</b>	No Internal Connection.
8	<b>ACG4</b>	No Internal Connection.
9	<b>ACG5</b>	No Internal Connection.
10	<b>ACG6</b>	No Internal Connection.
11	<b>GND</b>	RF/DC Ground Connection.
12	<b>ATTIN</b>	Digital Attenuator Input - DC Block Required.
13	<b>GND</b>	RF/DC Ground Connection.
14	<b>NC</b>	No Internal Connection.
15	<b>NC</b>	No Internal Connection.
16	<b>NC</b>	No Internal Connection.
17	<b>VDD</b>	Digital Attenuator Supply Voltage.
18	<b>D5</b>	Digital Attenuator Parallel Control Line - 16 dB Bit.
19	<b>D4</b>	Digital Attenuator Parallel Control Line - 8 dB Bit.
20	<b>D3</b>	Digital Attenuator Parallel Control Line - 4 dB Bit.
21	<b>D2</b>	Digital Attenuator Parallel Control Line - 2 dB Bit.
22	<b>D1</b>	Digital Attenuator Parallel Control Line - 1 dB Bit.
23	<b>D0</b>	Digital Attenuator Parallel Control Line - 0.5 dB Bit.
24	<b>NC</b>	No Internal Connection.
25	<b>NC</b>	No Internal Connection.
26	<b>NC</b>	No Internal Connection.
27	<b>NC</b>	No Internal Connection.
28	<b>GND</b>	RF/DC Ground Connection.
29	<b>AMPOUT/VCC</b>	Amplifier Output and Bias. External Choke, Bypassing and DC Blocks Required.
30	<b>GND</b>	RF/DC Ground Connection.
31	<b>GND</b>	RF/DC Ground Connection.
32	<b>GND</b>	RF/DC Ground Connection.

## Evaluation Schematic - 1800MHz to 2200MHz Application Circuit

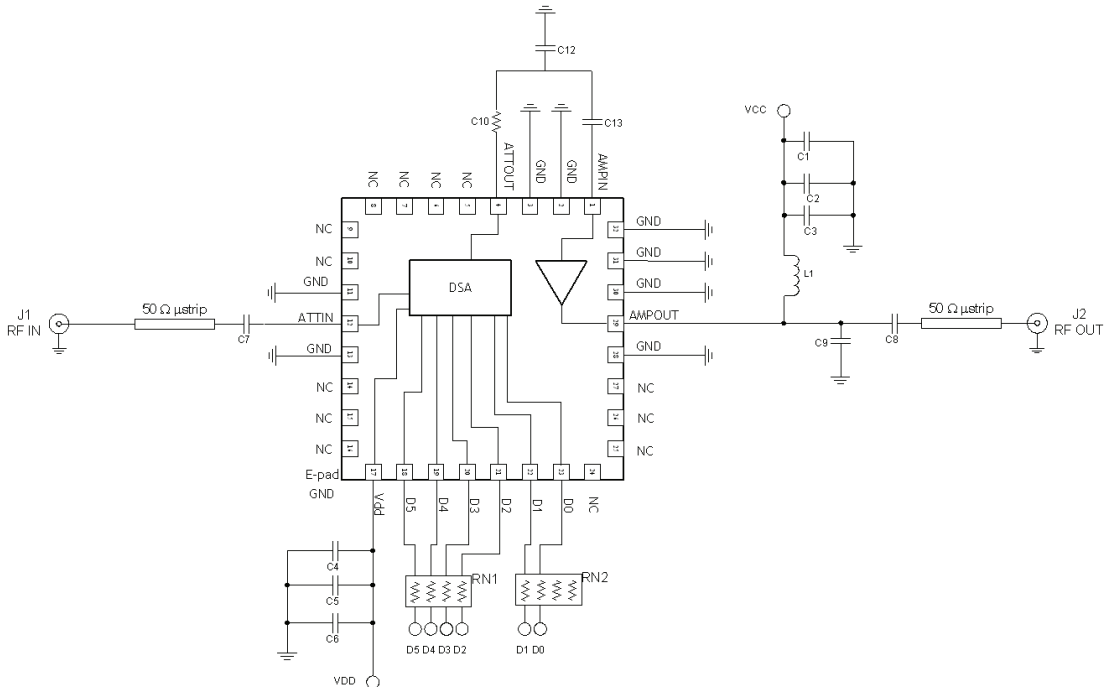

### Bill of Materials - 1800MHz to 2200MHz Application Circuit

Description	Reference Designator	Manufacturer	Manufacturer's P/N
RFDA2015SB	U1	RFMD	RFDA2015
RFDA2015, PCB			RFDA2015410 (A)
CONN, SMA, END LNCH, FLT, 0.062"	J1, J2	Emerson Network Power	142-0701-821
CAP, 1000pF, 10%, 50V, X7R, 0603	C2, C5	Murata Electronics	GRM188R71H102KA01D
CAP, 22pF, 5%, 50V, COG, 0402	C3, C7, C8	PANASONIC INDUSTRIAL CO	ECJ-OEC1H220J
CAP, 1uF, 10%, 16V, X7R, 0805	C1, C6	Murata Electronics	GRM21BR71C105KA01K
CAP, 100pF, 5%, 50V, COG, 0402	C4	PANASONIC INDUSTRIAL CO	ECJ-OEC1H101J
CAP, 1.2pF, +/-0.1pF, 50V, COG, 0402	C9	Murata Electronics	GRM1555C1H1R2BZ01E
IND, 18nH, 5%, M/L, 0603	L1	Toko America, Inc.	LL1608-FSL18NJ
RES, 0 OHM, 0402	C10	Kamaya, Inc	RMC1/16SJPTH
RES ARRAY, 4-ELEM, 1K, 5%, SMD 4 X 0402	RN1, RN2	KOA	CN1E4KTTD102J
CAP, 3.3pF, +/-0.1pF, 50V, COG, 0402	C13	Murata Electronics	GRM1555C1H3R3BZ01E
CONN, HDR, ST, PLRZD, 2-PIN, 0.100"	P2	ITW Pancon	MPSS100-2-C
CONN, HDR, ST, PLRZD, 14-PIN, 0.100"	P1	ITW Pancon	MPSS100-14-C
DNP	C11, C12, RN3, R1		



**Evaluation PCB - 1800MHz to 2200MHz Application Circuit**

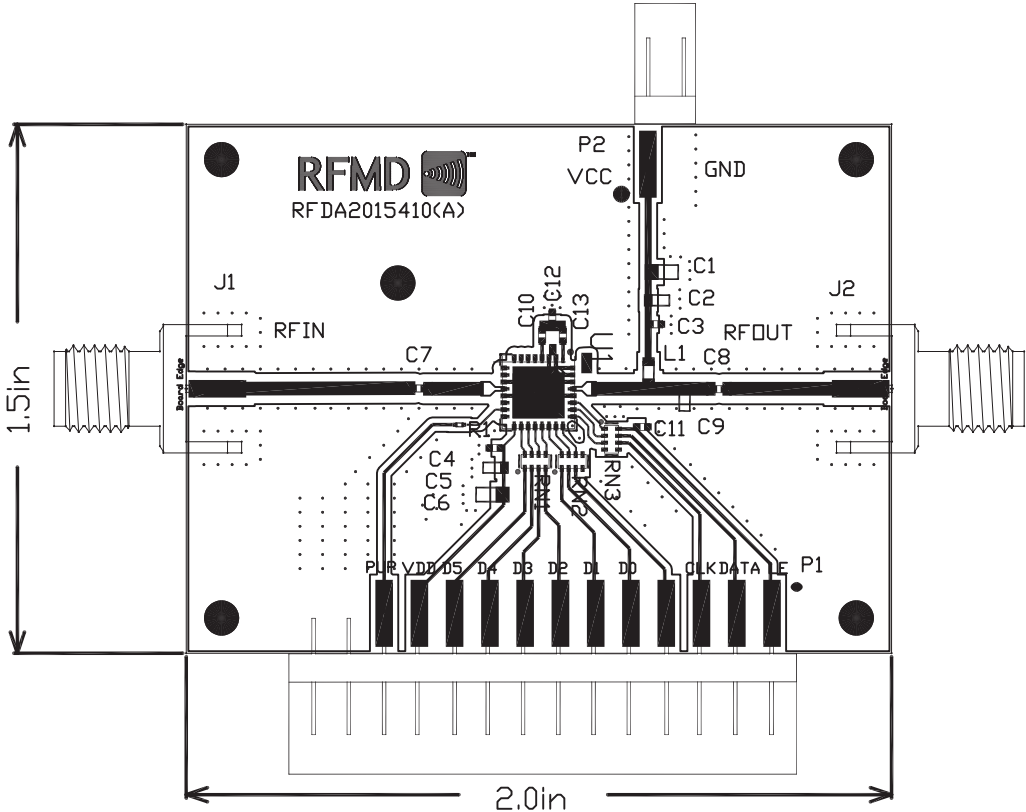

## Package Drawing

5.2mmx5.2mm Laminate Module

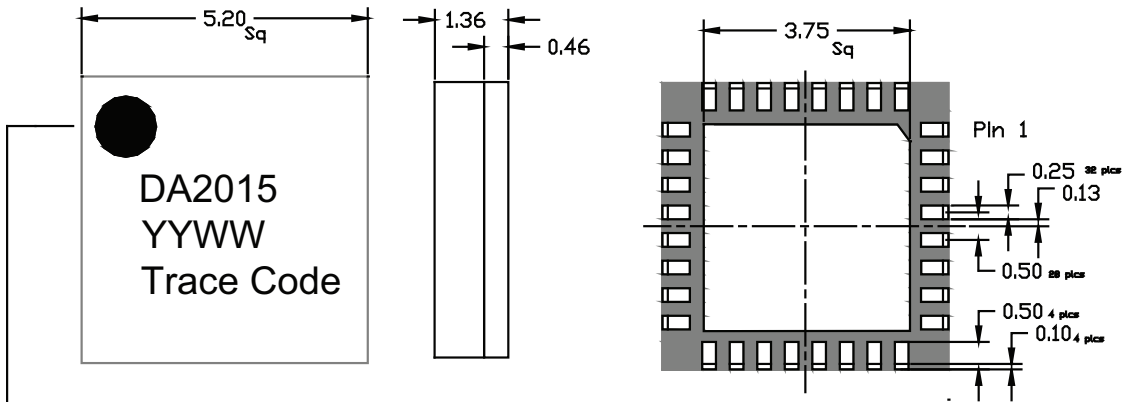

Pin 1 Indicator

Dimensions in millimeters

YY = Year  
WW = Week

Trace Code to be assigned by SubCon