

Schottky Rectifier, 5.5 A

D-PAK (TO-252AA)

FEATURES

- Low forward voltage drop
- Guard ring for enhanced ruggedness and long term reliability
- Halogen-free according to IEC 61249-2-21 definition
- Popular D-PAK outline
- Small foot print, surface mountable
- High frequency operation
- Meets MSL level 1, per J-STD-020, LF maximum peak of 260 °C
- Compliant to RoHS Directive 2002/95/EC

RoHS
 COMPLIANT
 HALOGEN
FREE

PRODUCT SUMMARY

Package	D-PAK (TO-252AA)
$I_{F(AV)}$	5.5 A
V_R	30 V
V_F at I_F	See Electrical table
I_{RM}	58 mA at 125 °C
T_J max.	150 °C
Diode variation	Single die
E_{AS}	10 mJ

DESCRIPTION

The VS-50WQ03FN-M3 surface mount Schottky rectifier has been designed for applications requiring low forward drop and small foot prints on PC board. Typical applications are in disk drives, switching power supplies, converters, freewheeling diodes, battery charging, and reverse battery protection.

MAJOR RATINGS AND CHARACTERISTICS

SYMBOL	CHARACTERISTICS	VALUES	UNITS
$I_{F(AV)}$	Rectangular waveform	5.5	A
V_{RRM}		30	V
I_{FSM}	$t_p = 5 \mu s$ sine	320	A
V_F	5 Apk, $T_J = 125 \text{ }^\circ\text{C}$	0.35	V
T_J	Range	- 40 to 150	°C

VOLTAGE RATINGS

PARAMETER	SYMBOL	VS-50WQ03FN-M3	UNITS
Maximum DC reverse voltage	V_R	30	V
Maximum working peak reverse voltage	V_{RWM}		

ABSOLUTE MAXIMUM RATINGS

PARAMETER	SYMBOL	TEST CONDITIONS	VALUES	UNITS
Maximum average forward current See fig. 5	$I_{F(AV)}$	50 % duty cycle at $T_C = 136 \text{ }^\circ\text{C}$, rectangular waveform	5.5	A
Maximum peak one cycle non-repetitive surge current See fig. 7	I_{FSM}	5 μs sine or 3 μs rect. pulse	320	A
		10 ms sine or 6 ms rect. pulse	130	
Non-repetitive avalanche energy	E_{AS}	$T_J = 25 \text{ }^\circ\text{C}$, $I_{AS} = 2 \text{ A}$, $L = 5 \text{ mH}$	10	mJ
Repetitive avalanche current	I_{AR}	Current decaying linearly to zero in 1 μs Frequency limited by T_J maximum $V_A = 1.5 \times V_R$ typical	2.0	A

ELECTRICAL SPECIFICATIONS					
PARAMETER	SYMBOL	TEST CONDITIONS		VALUES	UNITS
Maximum forward voltage drop See fig. 1	$V_{FM}^{(1)}$	5 A	$T_J = 25\text{ }^\circ\text{C}$	0.46	V
		10 A		0.53	
		5 A	$T_J = 125\text{ }^\circ\text{C}$	0.35	
		10 A		0.46	
Maximum reverse leakage current See fig. 2	$I_{RM}^{(1)}$	$T_J = 25\text{ }^\circ\text{C}$	$V_R = \text{Rated } V_R$	3	mA
		$T_J = 125\text{ }^\circ\text{C}$		58	
Threshold voltage	$V_{F(TO)}$	$T_J = T_J \text{ maximum}$		0.19	V
Forward slope resistance	r_t			22.22	m Ω
Typical junction capacitance	C_T	$V_R = 5 V_{DC}$ (test signal range 100 kHz to 1 MHz), 25 $^\circ\text{C}$		590	pF
Typical series inductance	L_S	Measured lead to lead 5 mm from package body		5.0	nH

Note

(1) Pulse width < 300 μs , duty cycle < 2 %

THERMAL - MECHANICAL SPECIFICATIONS					
PARAMETER	SYMBOL	TEST CONDITIONS		VALUES	UNITS
Maximum junction and storage temperature range	$T_J^{(1)}, T_{Stg}$			- 40 to 150	$^\circ\text{C}$
Maximum thermal resistance, junction to case	R_{thJC}	DC operation See fig. 4		3.0	$^\circ\text{C/W}$
Approximate weight				0.3	g
				0.01	oz.
Marking device		Case style D-PAK (similar to TO-252AA)		50WQ03FN	

Note

(1) $\frac{dP_{tot}}{dT_J} < \frac{1}{R_{thJA}}$ thermal runaway condition for a diode on its own heatsink

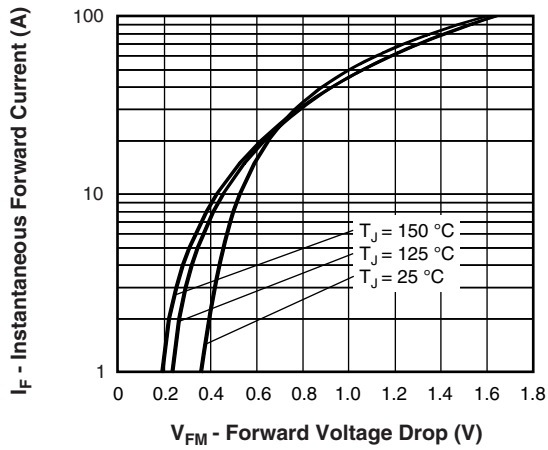

Fig. 1 - Maximum Forward Voltage Drop Characteristics

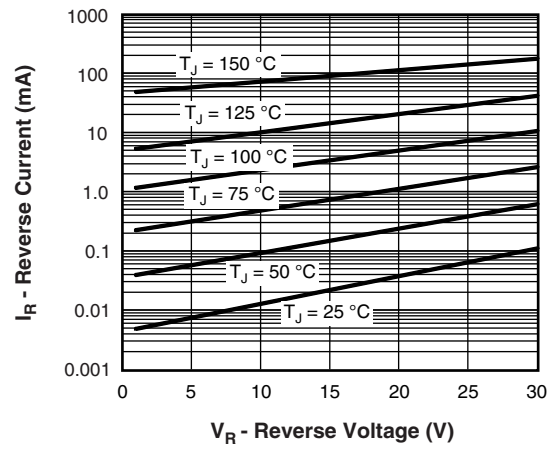

Fig. 2 - Typical Values of Reverse Current vs. Reverse Voltage

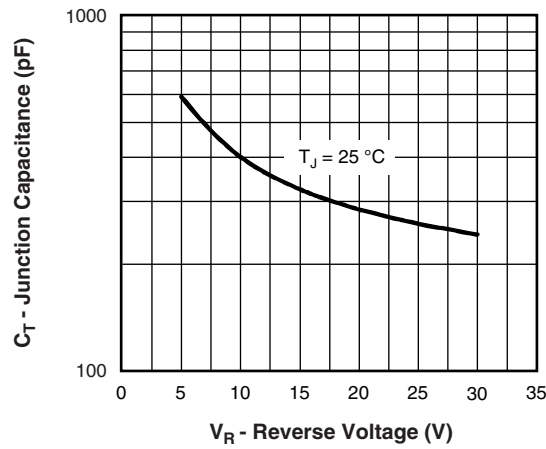
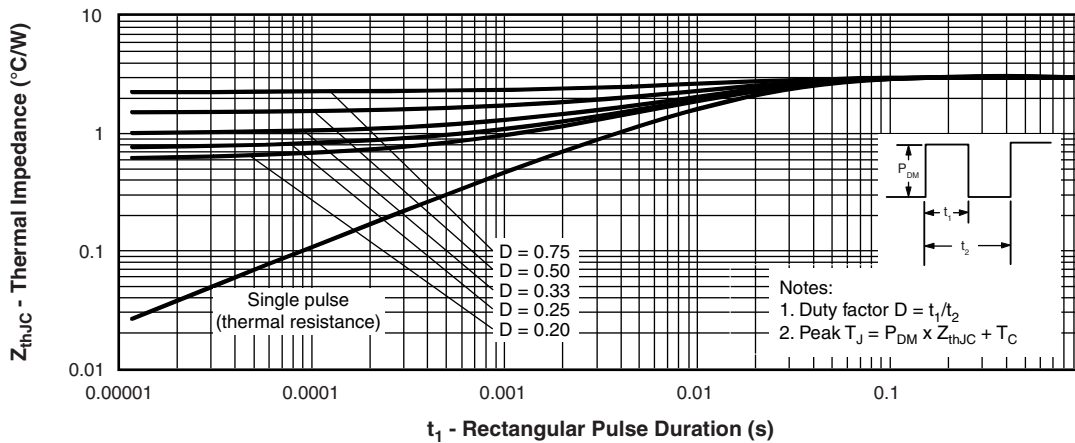

Fig. 3 - Typical Junction Capacitance vs. Reverse Voltage

 Fig. 4 - Maximum Thermal Impedance Z_{thJC} Characteristics

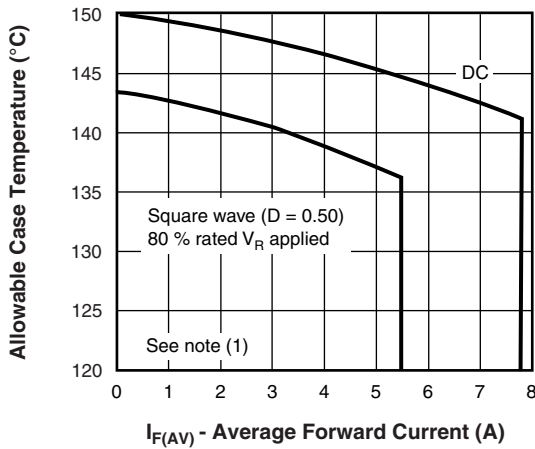

Fig. 5 - Maximum Allowable Case Temperature vs. Average Forward Current

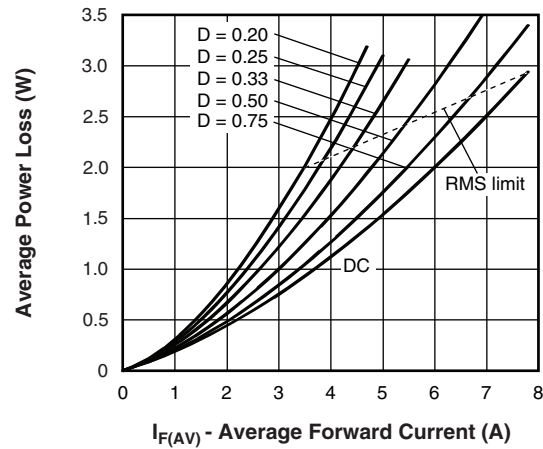

Fig. 6 - Forward Power Loss Characteristics

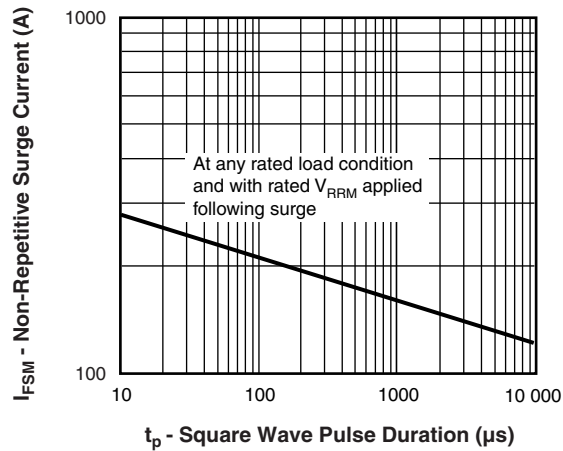

Fig. 7 - Maximum Non-Repetitive Surge Current

Note

- (1) Formula used: $T_C = T_J - (P_d + P_{d_{REV}}) \times R_{thJC}$;
 P_d = Forward power loss = $I_{F(AV)} \times V_{FM}$ at $(I_{F(AV)}/D)$ (see fig. 6);
 $P_{d_{REV}}$ = Inverse power loss = $V_{R1} \times I_R (1 - D)$; I_R at $V_{R1} = 80\%$ rated V_R



ORDERING INFORMATION TABLE

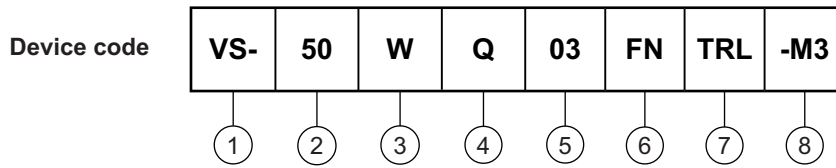

- 1** - Vishay Semiconductors product
- 2** - Current rating (5.5 A)
- 3** - Package identifier:
W = D-PAK
- 4** - Schottky "Q" series
- 5** - Voltage rating (03 = 30 V)
- 6** - FN = TO-252AA (D-PAK)
- 7** -
 - None = Tube
 - TR = Tape and reel
 - TRL = Tape and reel (left oriented)
 - TRR = Tape and reel (right oriented)
- 8** - Environmental digit:
-M3 = Halogen-free, RoHS compliant and terminations lead (Pb)-free

ORDERING INFORMATION (Example)			
PREFERRED P/N	QUANTITY PER T/R	MINIMUM ORDER QUANTITY	PACKAGING DESCRIPTION
VS-50WQ03FN-M3	75	3000	Antistatic plastic tube
VS-50WQ03FNTR-M3	2000	2000	13" diameter reel
VS-50WQ03FNTRL-M3	3000	3000	13" diameter reel
VS-50WQ03FNTRR-M3	3000	3000	13" diameter reel

LINKS TO RELATED DOCUMENTS	
Dimensions	www.vishay.com/doc?95016
Part marking information	www.vishay.com/doc?95176
Packaging information	www.vishay.com/doc?95033

D-PAK (TO-252AA)

DIMENSIONS in millimeters and inches

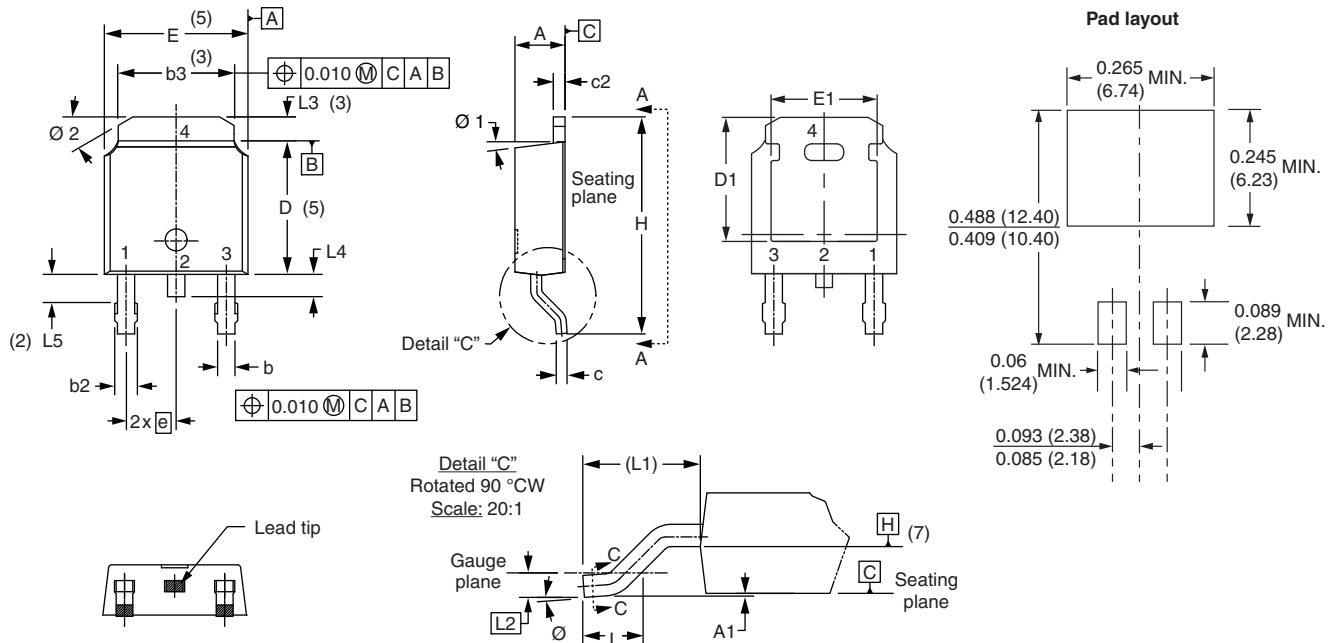

SYMBOL	MILLIMETERS		INCHES		NOTES	SYMBOL	MILLIMETERS		INCHES		NOTES
	MIN.	MAX.	MIN.	MAX.			MIN.	MAX.	MIN.	MAX.	
A	2.18	2.39	0.086	0.094		e	2.29 BSC		0.090 BSC		
A1	-	0.13	-	0.005		H	9.40	10.41	0.370	0.410	
b	0.64	0.89	0.025	0.035		L	1.40	1.78	0.055	0.070	
b2	0.76	1.14	0.030	0.045		L1	2.74 BSC		0.108 REF.		
b3	4.95	5.46	0.195	0.215	3	L2	0.51 BSC		0.020 BSC		
c	0.46	0.61	0.018	0.024		L3	0.89	1.27	0.035	0.050	3
c2	0.46	0.89	0.018	0.035		L4	-	1.02	-	0.040	
D	5.97	6.22	0.235	0.245	5	L5	1.14	1.52	0.045	0.060	2
D1	5.21	-	0.205	-	3	Ø	0°	10°	0°	10°	
E	6.35	6.73	0.250	0.265	5	Ø1	0°	15°	0°	15°	
E1	4.32	-	0.170	-	3	Ø2	25°	35°	25°	35°	

Notes

- (1) Dimensioning and tolerancing as per ASME Y14.5M-1994
- (2) Lead dimension uncontrolled in L5
- (3) Dimension D1, E1, L3 and b3 establish a minimum mounting surface for thermal pad
- (4) Section C - C dimension apply to the flat section of the lead between 0.13 and 0.25 mm (0.005 and 0.10") from the lead tip
- (5) Dimension D, and E do not include mold flash. Mold flash shall not exceed 0.127 mm (0.005") per side. These dimensions are measured at the outermost extremes of the plastic body
- (6) Dimension b1 and c1 applied to base metal only
- (7) Datum A and B to be determined at datum plane H
- (8) Outline conforms to JEDEC outline TO-252AA



Disclaimer

ALL PRODUCT, PRODUCT SPECIFICATIONS AND DATA ARE SUBJECT TO CHANGE WITHOUT NOTICE TO IMPROVE RELIABILITY, FUNCTION OR DESIGN OR OTHERWISE.

Vishay Intertechnology, Inc., its affiliates, agents, and employees, and all persons acting on its or their behalf (collectively, "Vishay"), disclaim any and all liability for any errors, inaccuracies or incompleteness contained in any datasheet or in any other disclosure relating to any product.

Vishay makes no warranty, representation or guarantee regarding the suitability of the products for any particular purpose or the continuing production of any product. To the maximum extent permitted by applicable law, Vishay disclaims (i) any and all liability arising out of the application or use of any product, (ii) any and all liability, including without limitation special, consequential or incidental damages, and (iii) any and all implied warranties, including warranties of fitness for particular purpose, non-infringement and merchantability.

Statements regarding the suitability of products for certain types of applications are based on Vishay's knowledge of typical requirements that are often placed on Vishay products in generic applications. Such statements are not binding statements about the suitability of products for a particular application. It is the customer's responsibility to validate that a particular product with the properties described in the product specification is suitable for use in a particular application. Parameters provided in datasheets and/or specifications may vary in different applications and performance may vary over time. All operating parameters, including typical parameters, must be validated for each customer application by the customer's technical experts. Product specifications do not expand or otherwise modify Vishay's terms and conditions of purchase, including but not limited to the warranty expressed therein.

Except as expressly indicated in writing, Vishay products are not designed for use in medical, life-saving, or life-sustaining applications or for any other application in which the failure of the Vishay product could result in personal injury or death. Customers using or selling Vishay products not expressly indicated for use in such applications do so at their own risk. Please contact authorized Vishay personnel to obtain written terms and conditions regarding products designed for such applications.

No license, express or implied, by estoppel or otherwise, to any intellectual property rights is granted by this document or by any conduct of Vishay. Product names and markings noted herein may be trademarks of their respective owners.

Material Category Policy

Vishay Intertechnology, Inc. hereby certifies that all its products that are identified as RoHS-Compliant fulfill the definitions and restrictions defined under Directive 2011/65/EU of The European Parliament and of the Council of June 8, 2011 on the restriction of the use of certain hazardous substances in electrical and electronic equipment (EEE) - recast, unless otherwise specified as non-compliant.

Please note that some Vishay documentation may still make reference to RoHS Directive 2002/95/EC. We confirm that all the products identified as being compliant to Directive 2002/95/EC conform to Directive 2011/65/EU.

Vishay Intertechnology, Inc. hereby certifies that all its products that are identified as Halogen-Free follow Halogen-Free requirements as per JEDEC JS709A standards. Please note that some Vishay documentation may still make reference to the IEC 61249-2-21 definition. We confirm that all the products identified as being compliant to IEC 61249-2-21 conform to JEDEC JS709A standards.