



Kotron® Model 811 RF Point Level Switch

DESCRIPTION

The Kotron® Model 811 Level Switch offers the user great flexibility. The switch can be used either as a single alarm relay with narrow differential or for control purposes with an adjustable differential. Using the proven RF Capacitance technology, the Model 811 provides reliable operation for a broad range of applications.

FEATURES

- Useable for both narrow differential (alarm) and wide differential (control)
- Intrinsically safe probe circuitry yields extra degree of safety even with bare probes in hazardous media
- Remote mounting up to 150 feet (45 meters) with no preamplifier on the probe provides protection from high process temperatures or heavy vibration
- 10-amp DPDT relay provides flexibility for both alarm and control applications
- Guard circuitry and probe reject buildup of media
- Useable with all Kotron probes for application flexibility
- LED shows relay status and aids in calibration and troubleshooting
- 0 to 120 second time delay feature eliminates relay chatter due to turbulence
- Field selectable high level/low level failsafe
- Conformally coated circuit boards reduce circuit problems due to moisture and fungus



APPLICATIONS

- Clean or dirty liquids
- Viscous liquids
- Light slurries
- Corrosive liquids
- High temperature/pressure liquids
- Hydrocarbons and solvents
- Acids and caustics
- Foods and beverages

TYPICAL APPLICATION

Pump / Valve Control

The Model 811 handles alarm applications as well as pump/valve control applications with a wide or adjustable differential.

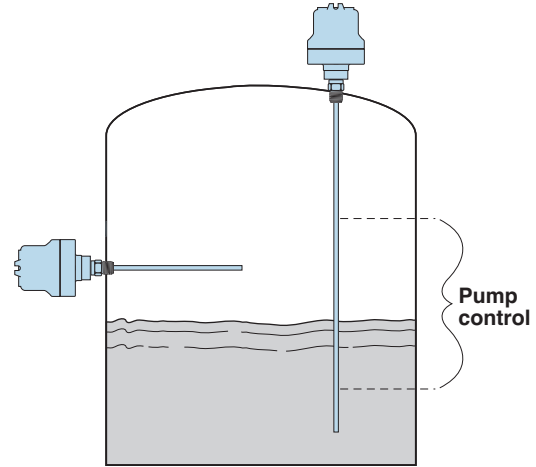

Coating Rejection

The Model 811 provides rejection of conductive buildup by utilizing a guarded probe. Coating rejection circuit is standard on all units.

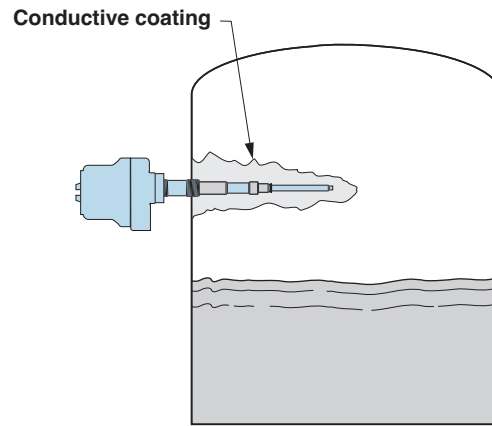

Intrinsically Safe

The Model 811-1X06-E0X is inherently intrinsically safe when the main amplifier is mounted in a non-hazardous area. Barriers are included in the 811 electronics eliminating the need for separate barriers.

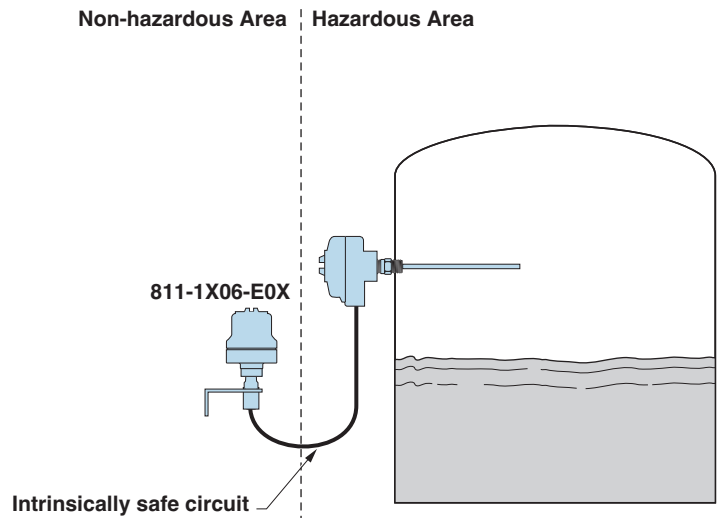

TECHNOLOGY

The amount of capacitance developed in any vessel is determined by the size (surface area) of the probe, the distance from the probe to its ground, and the dielectric of the medium being measured. Considering that the probe's mounting position is fixed and that the dielectric value of the medium is constant, then the amount of capacitance developed in any vessel becomes dependent upon the amount of the probe which is covered by the media.

As media rises and falls in the tank, the amount of capacitance developed between the sensing probe and the ground also rises and falls. This change in capacitance is compared to the adjustable set point and changes the state of a relay when they are equal.

SPECIFICATIONS

Supply voltage		120 VAC, 50–60 Hz (+10%, -15%)
		240 VAC, 50–60 Hz (+10%, -15%)
		24 VDC (±10%)
		12 VDC (±10%)
Power consumption	120 or 240 VAC	Less than 5 volt-amps
	12 or 24 VDC	1 watt maximum
Zero range		0 pF minimum to 1000 pF maximum
Adjustable differential		0.5 to 700 pF
Output relays (DPDT) with gold flash contacts	AC	10 amp @ 120/240 VAC resistive
	DC	10 amp @ 30 VDC resistive
	DC	0.5 amp @ 125 VDC resistive
Response time		100 milliseconds
Repeatability		Better than 1.0%
Ambient temperature	Electronics	-40° to +160° F (-40° to +70° C)
Operating process pressure/temperature		Dependent upon probe selection; refer to probe bulletin 50–125
	Guarded probe 8XD-AAXA-OXX	3500 psig @ +100° F (240 bar @ +40° C)
Temperature coefficient of set point		
	-40° to +160° F (-40° to +70° C)	±.01% per degree F of setpoint (±.018% per degree C of setpoint)

DIMENSIONAL SPECIFICATIONS

INCHES (mm)

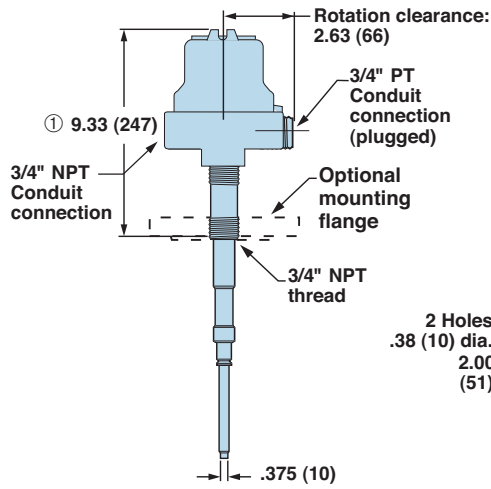

Integral Mount with Guarded Probe

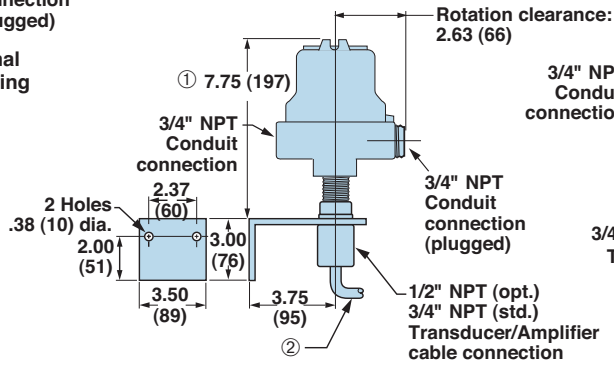

Remote Mount with Guarded Probe

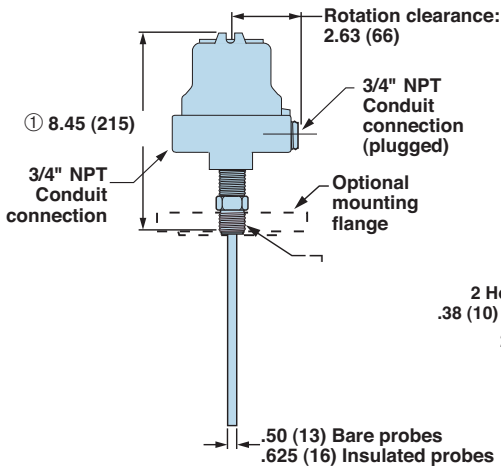
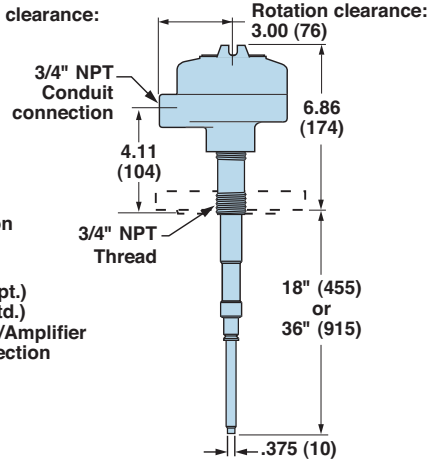

Integral Mount with Standard Rigid Probe

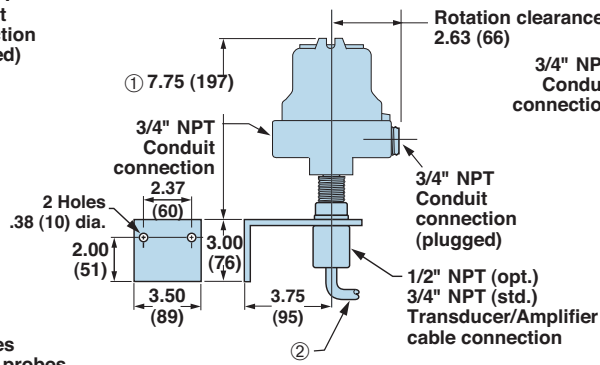

Remote Mount with Standard Rigid Probe

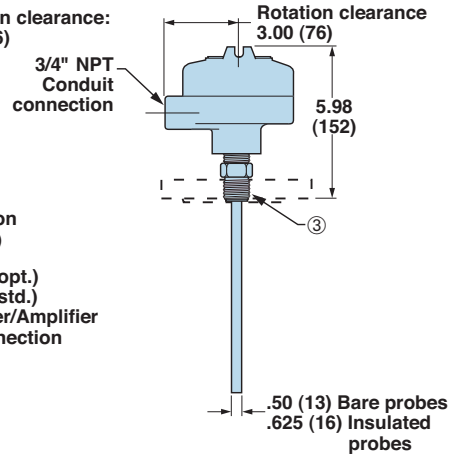

DIMENSIONAL SPECIFICATIONS

INCHES (mm)

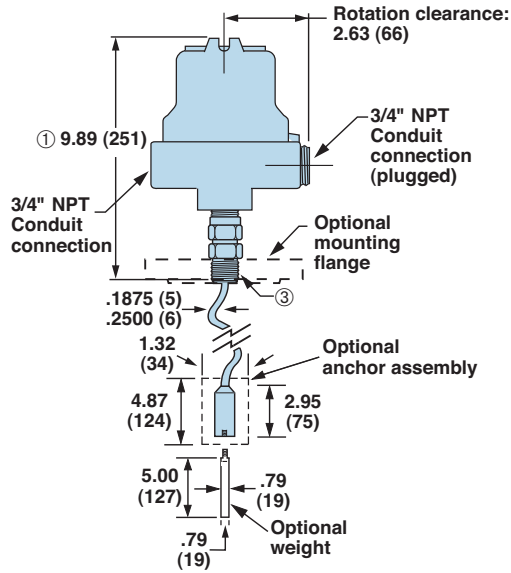

Integral Mount with Flexible Probe

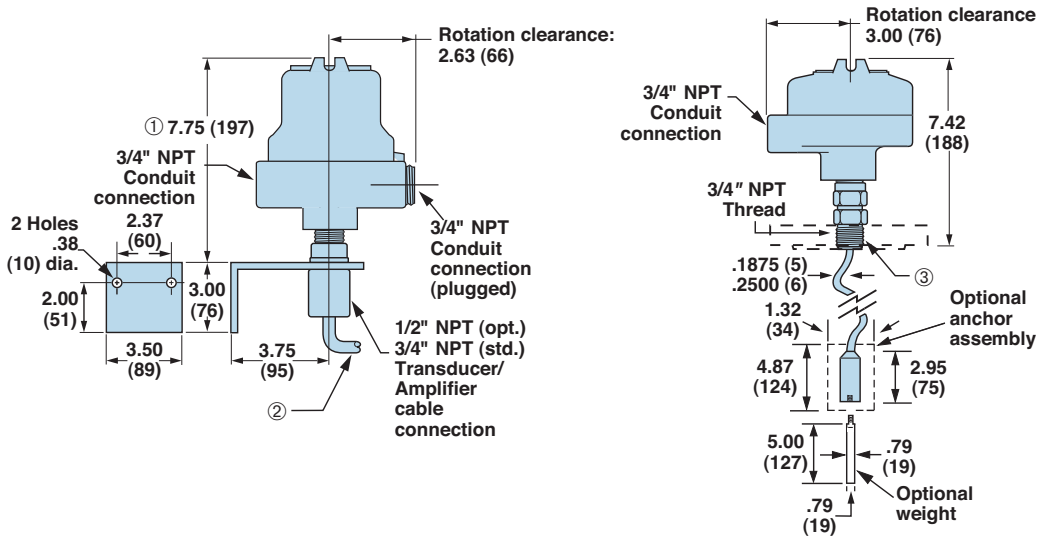



Remote Mount with Flexible Probe

NOTES:

- ① Allow 6.00 (152) overhead clearance for removal of cover.
- ② Probe/Amplifier Connecting Cable to be triaxial. Magnetrol part number 037-3180-XXX standard or part number 037-3184-XXX high temperature.
- ③ Standard process connection is 3/8" NPT. Consult probe brochure (50-125) for flange and other probe connections.

AGENCY APPROVALS

AGENCY	APPROVED MODEL	PROTECTION METHOD	AREA CLASSIFICATION
FM  APPROVED	811-1X05-E0X	Explosion Proof	Explosion proof with intrinsically safe probe circuit Class I, Div. 1, Groups C & D Class II, Div. 1, Groups E, F, & G NEMA 4X
	811-1X06-E0X with probe models: 041-5XXX-XXX and 8XX-XXX-XXX		
	811-1X06-E0X (Remote) with probe models: 041-5XXX-XXX and 8XX-XXX-XXX	Intrinsically Safe	Remote probe: Class I, Groups A, B, C, & D Class II, Div. 1, Groups E, F, & G Class III, NEMA 4X
CSA 	811-1X05-E0X	Explosion Proof	Explosion proof with intrinsically safe probe circuit Class I, Div. 1, Groups C & D Class II, Div. 1, Groups E, F, & G <i>(Bare probes not approved for Groups E & F)</i> TYPE 4X
	811-1X06-E0X with probe models: 041-5XXX-XXX and 8XX-XXX-XXX		
	811-1X06-E0X (Remote) with probe models: 041-5XXX-XXX and 8XX-XXX-XXX	Intrinsically Safe	Remote probe: Class I, Div. 1, Groups A, B, C, & D Class II, Div. 1, Groups E, F, & G <i>(Bare probes are not approved for Groups E & F)</i> Class III, TYPE 4X

 These units have been tested to EN 50081-2 and EN 50082-2 and are in compliance with the EMC Directive 89/336/EEC.

MODEL NUMBER

FM & CSA APPROVED

Models available for quick shipment, usually within one week after factory receipt of a complete purchase order, through the Expedite Ship Plan (ESP).
Applies only if Model 811 and selected probe both qualify for ESP.

BASIC MODEL

811	Kotron RF Capacitance Level Switch
-----	------------------------------------

INPUT POWER

0	120 VAC
1	240 VAC
2	24 VDC
3	12 VDC

MOUNTING

5	Integral
6	Remote

HOUSING

E	NEMA 4X/7/9 Groups C & D, aluminum, 3/4" NPT dual conduit
Y	NEMA 4X/7/9 Groups C & D, stainless steel, 3/4" NPT single conduit

PROBE

0	Probe ordered separately
1	18" (455 mm) guarded probe
2	36" (915 mm) guarded probe

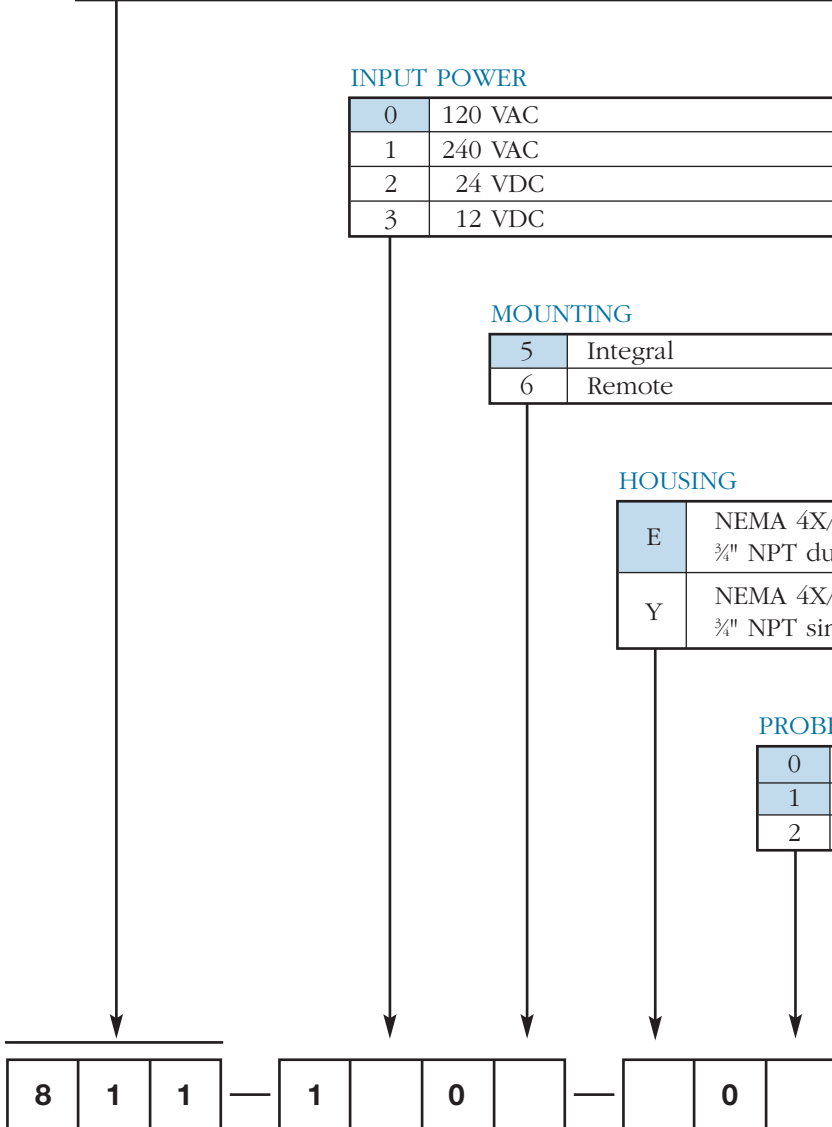

PROBES

A full range of rigid and flexible probes for conductive and non-conductive materials is available in various lengths and materials of construction. For further information on probe assemblies, refer to bulletin 50-125.

REMOTE CABLE

Specify connecting cable by exact length between 10 and 150 feet.

Standard cable (+175° F / +80° C) Magnetrol part number 037-3180-XXX (length in feet).

High temperature cable (+390° F / +200° C)

Magnetrol part number 037-3184-XXX (length in feet).

QUALITY



The quality assurance system in place at Magnetrol guarantees the highest level of quality throughout the company. Magnetrol is committed to providing full customer satisfaction both in quality products and quality service.

Magnetrol's quality assurance system is registered to ISO 9001 affirming its commitment to known international quality standards providing the strongest assurance of product and service quality available.

ESP

Expedite Ship Plan

Several Kotron Model 811 RF Point Switches are available for quick shipment, usually within one week after factory receipt of a purchase order, through the Expedite Ship Plan (ESP).

To take advantage of ESP, simply match the

color coded model number codes (standard dimensions apply).

ESP service may not apply to orders of ten units or more. Contact your local representative for lead times on larger volume orders, as well as other products and options.

WARRANTY



All Magnetrol electronic level and flow controls are warranted free of defects in materials or workmanship for one full year from the date of original factory shipment.

If returned within the warranty period; and, upon factory inspection of the control, the cause of the claim is determined to be covered under the warranty; then, Magnetrol will repair or replace the control at no cost

to the purchaser (or owner) other than transportation.

Magnetrol shall not be liable for misapplication, labor claims, direct or consequential damage or expense arising from the installation or use of equipment. There are no other warranties expressed or implied, except special written warranties covering some Magnetrol products.

For additional information, see Instruction Manual 50-608.



5300 Belmont Road • Downers Grove, Illinois 60515-4499 • 630-969-4000 • Fax 630-969-9489 • www.magnetrol.com
145 Jardin Drive, Units 1 & 2 • Concord, Ontario Canada L4K 1X7 • 905-738-9600 • Fax 905-738-1306
Heikensstraat 6 • B 9240 Zele, Belgium • 052 45.11.11 • Fax 052 45.09.93
Regent Business Ctr., Jubilee Rd. • Burgess Hill, Sussex RH15 9TL U.K. • 01444-871313 • Fax 01444-871317

Copyright © 2010 Magnetrol International, Incorporated. All rights reserved. Printed in the USA.
Performance specifications are effective with date of issue and are subject to change without notice.

Magnetrol & Magnetrol logotype and Kotron are registered trademarks of Magnetrol International.

BULLETIN: 50-103.7
EFFECTIVE: May 2010
SUPERSEDES: April 2005