

# THT POWER INDUCTORS

## Toroid - Vertical, Low Profile and *KlipMount*<sup>™</sup>

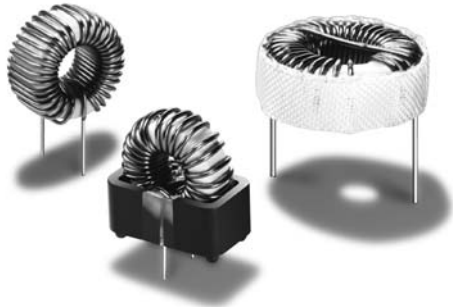

- Available in vertical, low profile and *KlipMount*<sup>™</sup>
- SMPS averaging filter
- Characterized for general purpose use and ripple filters
- Single-layer designs
- Can be used as differential mode inductors in EMI filters<sup>3</sup>

### Electrical Specifications @ 25°C — Operating Temperature -40°C to 130°C

REFERENCE OPERATING VALUES						DESIGN CONTROL VALUES					
Vertical <sup>6</sup> Part Number	Low Profile Part Number	Inductance <sup>1</sup> Typical ( $\mu$ H)	I <sub>DC</sub> (AMPS)	ET <sub>TOP</sub> (V- $\mu$ Sec)	Energy <sup>4</sup> Storage ( $\mu$ J)	Inductance No DC ( $\mu$ H) $\pm 20\%$	20kHz Test mV No DC <sub>2</sub>	DCR <sup>5</sup> ( $\Omega$ MAX)	Coil Size Code	Klip* Mount Package	Lead Diameter (In) $\pm .003$
PE-51591	—	20	2.0	52	40	32.8	33	.060	H	—	.020
PE-92100	—	25	2.6	30	85	20.7	22	.043	A	KM1	.020
PE-92101	PE-92401	50	2.6	50	169	45.7	45	.071	B	KM2	.020
PE-92102	PE-92402	100	2.6	90	338	94.1	90	.100	C	KM3	.020
PE-92103	—	35	2.6	55	118	28.4	36	.037	B	KM2	.025
PE-92104	PE-92404	70	3.0	85	315	61.0	73	.052	C	KM3	.025
PE-92105	PE-92405	145	3.0	140	653	141.8	140	.087	D	KM4	.025
PE-92106	—	285	3.0	300	1283	264.1	340	.140	E	KM5	.025
PE-92107	—	450	3.0	425	2025	436.3	500	.200	F	—	.025
PE-92108	PE-92408	67	3.6	130	648	90.7	110	.045	D	KM4	.032
PE-92109	—	165	4.0	240	1320	152.0	260	.070	E	KM5	.032
PE-92110	—	270	4.0	350	2160	263.9	400	.100	F	—	.032
PE-92111	—	40	4.0	70	320	37.9	57	.027	C	KM3	.032
PE-51590	—	22	5.0	44	275	20.3	37	.020	G	—	.032
PE-92112	PE-92412	100	5.0	200	1250	90.7	180	.034	E	KM5	.042
PE-92113	—	170	5.0	300	2125	159.7	310	.050	F	—	.042
PE-92114	PE-92414	35.6	5.0	100	688	55.6	88	.023	D	KM4	.042
PE-92115	—	95	7.0	225	2328	96.0	200	.025	F	—	.051
PE-92116	PE-92416	55	7.0	150	1348	49.1	100	.017	E	KM5	.051
PE-92117	—	55	10.0	175	2750	55.9	120	.013	F	—	.064

\*Parts available with *KlipMount* option can be ordered by adding a "K" suffix to the part number (i.e. PE-92100K).

### Relationships Between Reference and Operating Conditions

Inductance vs. DC Current  
(at reference ET)

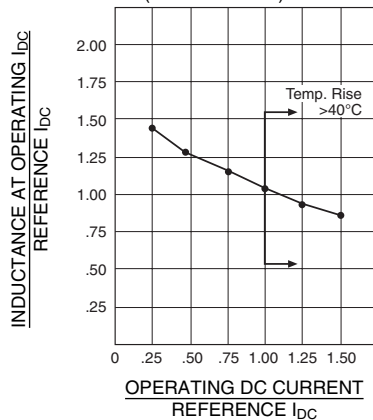

Inductance vs. Operating ET  
(at reference I<sub>DC</sub>)

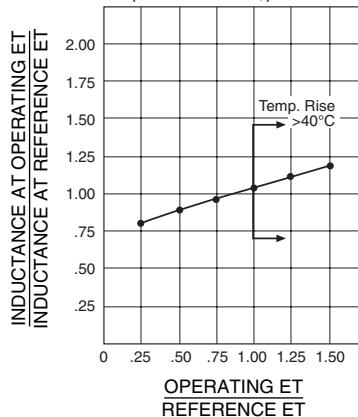

Max. Operating ET vs. Frequency  
(at reference I<sub>DC</sub>)

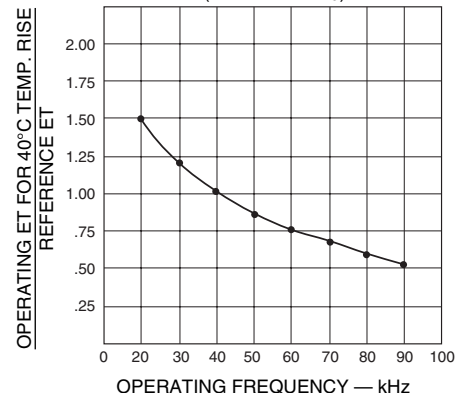

# THT POWER INDUCTORS

## Toroid - Vertical, Low Profile and KlipMount™



### Mechanicals

- Base material meets flammability requirements of UL 94V-0
- Mechanically rigid mount
- PC board — automatic insertability
- Lowest cost

### KlipMount™ Package

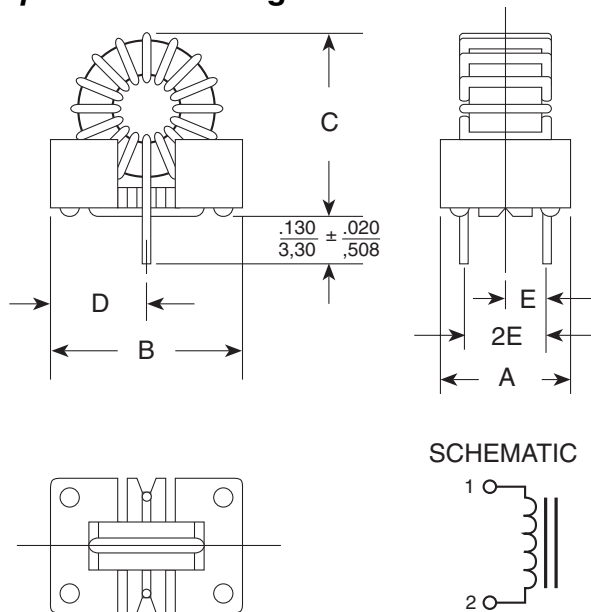

Standard Package	A	B	C	D	E
	Maximum			Typical	
KM-1	.340 8,64	.580 14,73	.650 16,51	.29 7,37	.110 2,79
KM-2	.450 11,43	.650 16,51	.700 17,78	.325 8,26	.150 3,81
KM-3	.450 11,43	.850 21,59	.950 24,13	.415 10,54	.150 3,81
KM-4	.620 15,50	.970 24,64	1.10 27,94	.475 12,07	.225 5,72
KM-5	.700 17,78	1.30 33,02	1.40 35,56	.625 15,88	.250 6,35

**Note:** Units with large wire sizes may exceed B dimension.  
**KLIPMOUNT™** is a trademark of Pulse Engineering, Inc.

**Dimensions:** Inches / mm Unless otherwise specified, all tolerances are ± .010 / 0,25

Coil Size	P (MAX)	N (MAX)	L (+.125/-.025)	M	K
A	.550 13,97	.250 6,35	.375 9,53	.180 4,57	—
B	.700 17,78	.380 9,65	.375 9,53	.280 7,11	.530 ± .050 13,46 ± 1,27
C	.850 21,59	.410 10,41	.375 9,53	.280 7,11	.720 ± .050 18,29 ± 1,27
D	1.050 26,67	.550 13,97	.375 9,53	.400 10,16	.840 ± .020 21,24 ± 0,51
E	1.400 35,56	.700 17,78	.375 9,53	.500 12,7	1.100 ± .100 27,94 ± 2,54
F	1.650 41,91	.700 17,78	.375 9,53	.500 12,7	—
G	.850 21,59	.330 8,38	.875 22,23	.330 8,38	—
H	.640 16,26	.280 7,11	.875 22,23	.280 7,11	—

### Vertical Package

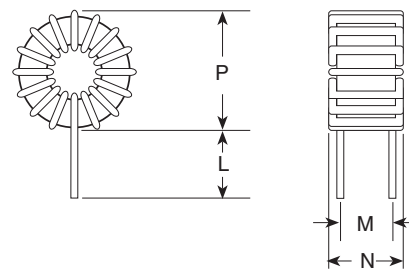

### Low Profile Package

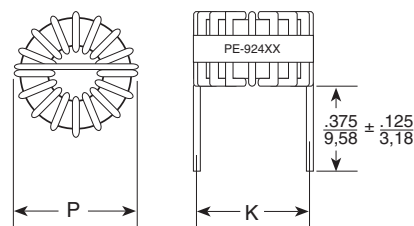

#### NOTES:

1. Typical Inductance occurs at I<sub>DC</sub> and E<sub>TOP</sub> values shown.
2. Design control test voltage is critical. Inductance increases with voltage.
3. For line filter applications, RMS line current is limited to specified reference DC Current.
4.  $\frac{LI^2}{2}$  rating is the ability of the inductor to store energy.
5. DCR for vertical part measured close to coil. Add 10% more for low profile part.
6. RoHS compliant parts are available. Order RoHS compliant parts by adding the suffix "NL" to the part number (i.e. PE-51591 becomes PE-51591NL).

### For More Information:

Pulse Worldwide Headquarters	Pulse Northern Europe	Pulse Southern Europe	Pulse China Headquarters	Pulse North China	Pulse South Asia	Pulse North Asia
12220 World Trade Drive San Diego, CA 92128 U.S.A. www.pulseeng.com TEL: 858 674 8100 FAX: 858 674 8262	3 Huxley Road Surrey Research Park Guildford, Surrey GU2 5RE United Kingdom TEL: 44 1483 401700 FAX: 44 1483 401701	Zone Industrielle F-39270 Orgelet France TEL: 33 3 84 35 04 04 FAX: 33 3 84 25 46 41	No. 1 Industrial District Changan, Dongguan China TEL: 86 769 85538070 FAX: 86 769 85538870	Room 1503 XinYin Building No. 888 YiShan Road Shanghai 200233 China TEL: 86 21 54643211/2 FAX: 86 21 54643210	150 Kampong Ampat #07-01/02 KA Centre Singapore 368324 TEL: 65 6287 8998 FAX: 65 6280 0080	No. 26 Kao Ching Road Yang Mei Chen Taoyuan Hsien Taiwan, R. O. C. TEL: 886 3 4641811 FAX: 886 3 4641911

Performance warranty of products offered on this data sheet is limited to the parameters specified. Data is subject to change without notice. Other brand and product names mentioned herein may be trademarks or registered trademarks of their respective owners.  
 © Copyright, 2006. Pulse Engineering, Inc. All rights reserved.