

450-3708 Solder mount socket, for .080 (2,03) diameter pins

Recommended mounting hole .116 (2,95) +.004 (0,10) - .000 (0,00), #32 drill

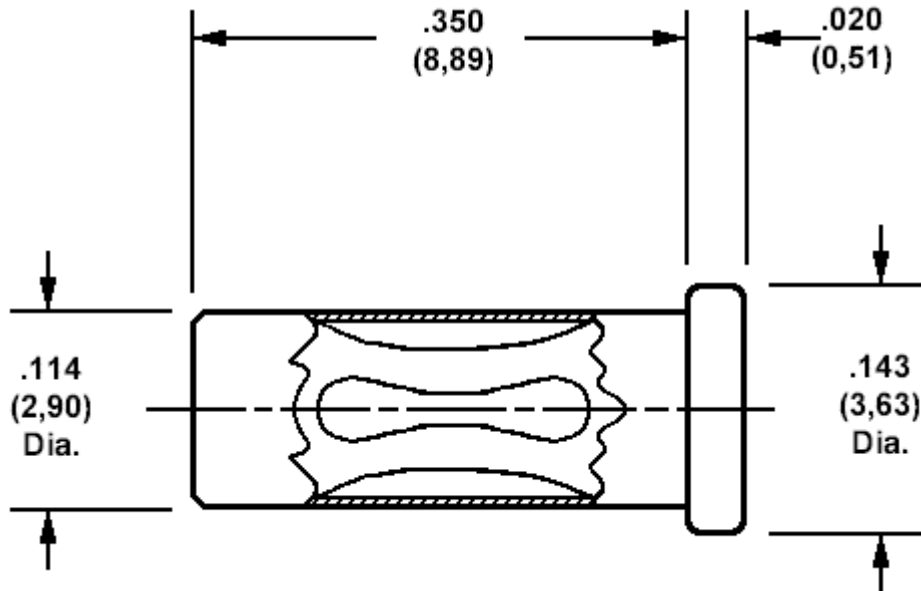

Min hole depth .359 (9,12)

How to order code
450-3708-01-XX-00
 Basic Part No XX = Finish

MATERIALS				
Component	Material	Finish(-03)	Finish(-04)	Finish(-06)
Body	Copper	Gold over Nickel	Tin	Tin
Spring	Beryllium copper	Gold over Nickel	Tin	Gold over Nickel