



81CXXX/81NXXX

CMOS IC

VOLTAGE DETECTORS WITH BUILT-IN DELAY TIME

DESCRIPTION

The UTC **81CXXX** and **81NXXX** series are good performance voltage detector and manufactured by CMOS technologies with highly accurate, low power consumption. A delay circuit is built-in to each detector, therefore, peripherals are unnecessary and high density mounting is possible. Detect voltage is extremely accurate with minimal temperature drift. Both CMOS and N-channel open drain output configurations are available.

FEATURES

- *Highly Accurate : Detect voltage $\pm 2\%$
- *Built-In Delay time : 1ms ~ 50ms,
50ms ~ 200ms,
200ms ~ 400ms,
- *Detect Voltage Temperature Characteristics:
TYP ± 100 ppm/
- *Wide Operating Voltage Range : 0.7V ~ 10.0V
- *Low Current Consumption : TYP 1.0 μ A ($V_{IN}=2.0V$)

ORDERING INFORMATION

CMOS:

Order Number		:Delay Time		Package	Pin Assign.			Packing		
Normal	Lead Free Plating	Duration	Code		1	2	3			
81Cxx- -AB3-E-R	81CxxL- -AB3-E-R	1 ~ 50 ms	P	SOT-89	O	I	G	Tape Reel		
81Cxx- -AE3-3-R	81CxxL- -AE3-3-R			SOT-23	O	G	I	Tape Reel		
81Cxx- -AE3-5-R	81CxxL- -AE3-5-R			SOT-23	G	O	I	Tape Reel		
81Cxx- -T92-D-B	81CxxL- -T92-D-B			50 ~ 200 ms	Q	TO-92	I	G	O	Tape Box
81Cxx- -T92-E-B	81CxxL- -T92-E-B			200 ~ 400 ms	R	TO-92	O	I	G	Tape Box
81Cxx- -T92-D-K	81CxxL- -T92-D-K					TO-92	I	G	O	Bulk
81Cxx- -T92-E-K	81CxxL- -T92-E-K					TO-92	O	I	G	Bulk

N-Channel:

Order Number		:Delay Time		Package	Pin Assign.			Packing		
Normal	Lead Free Plating	Duration	Code		1	2	3			
81Nxx- -AB3-E-R	81NxxL- -AB3-E-R	1 ~ 50 ms	H	SOT-89	O	I	G	Tape Reel		
81Nxx- -AE3-3-R	81NxxL- -AE3-3-R			SOT-23	O	G	I	Tape Reel		
81Nxx- -AE3-5-R	81NxxL- -AE3-5-R			SOT-23	G	O	I	Tape Reel		
81Nxx- -T92-D-B	81NxxL- -T92-D-B			50 ~ 200 ms	J	TO-92	I	G	O	Tape Box
81Nxx- -T92-E-B	81NxxL- -T92-E-B			200 ~ 400 ms	K	TO-92	O	I	G	Tape Box
81Nxx- -T92-D-K	81NxxL- -T92-D-K					TO-92	I	G	O	Bulk
81Nxx- -T92-E-K	81NxxL- -T92-E-K					TO-92	O	I	G	Bulk

Note: 1. Pin assignment: I:Vin O:Vout G:Vss
2.xx: Output Voltage, refer to Marking Information.

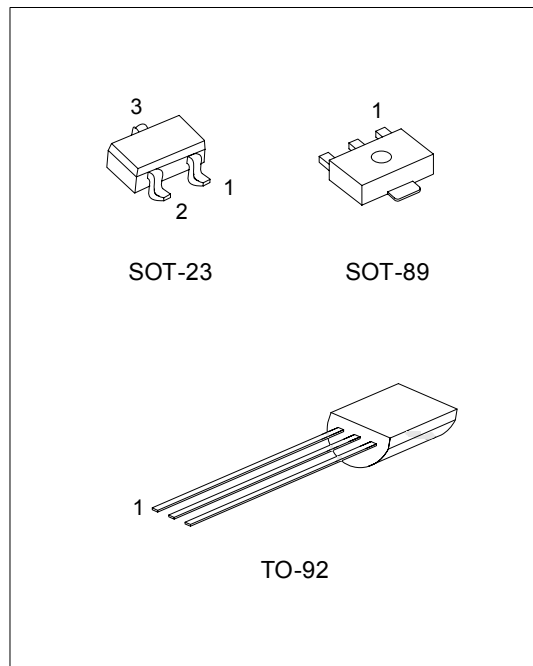

*Pb-free plating product number: 81CXXXL/81NXXXL

ORDERING INFORMATION(Cont.)

<p>81CxxL-①-AB3-x-R</p>	<p>(1) Packing Type (2) Pin Code (3) Package Type (4) Delay Time (5) Lead Plating (6) Output Voltage Code (7) Output Configuration</p>	<p>(1) R: Tape Reel, B: Tape Box, K: Bulk (2) refer to Pin Assignment (3) AB3: SOT-89, AE3: SOT-23, T92: TO-92 (4) ①: refer to Delay Time (5) L: Lead Free Plating, Blank: Pb/Sn (6) xx: refer to Marking Information (7) C: CMOS, N: N-Channel</p>
-------------------------	--	---

MARKING INFORMATION

PACKAGE	VOLTAGE CODE			MARKING		
SOT-89	10:1.0V					
	11:1.1V	26:2.6V				
	12:1.2V	27:2.7V	40:4.0V			
	13:1.3V	28:2.8V	41:4.1V			
	14:1.4V	29:2.9V	42:4.2V			
	15:1.5V	30:3.0V	43:4.3V			
	16:1.6V	31:3.1V	44:4.4V			
	17:1.7V	32:3.2V	45:4.5V			
	18:1.8V	33:3.3V	46:4.6V			
	19:1.9V	34:3.4V	47:4.7V			
	20:2.0V	35:3.5V	48:4.8V			
	21:2.1V	36:3.6V	49:4.9V			
	22:2.2V	37:3.7V	50:5.0V			
	23:2.3V	38:3.8V				
	24:2.4V	39:3.9V				
	25:2.5V					
	TO-92					

PACKAGE	INTEGER*	CODE	DECIMAL**	CODE	MARKING
SOT-23	1.	1	.0	A	
	2.	2	.1	B	
	3.	3	.2	C	
	4.	4	.3	D	
	5.	5	.4	E	
	6.	6	.5	F	
			.6	G	
			.7	H	
			.8	J	
			.9	K	

* Represents the integer of the Detect Voltage
 ** Represents the decimal number of the Detect Voltage

EXAMPLE:

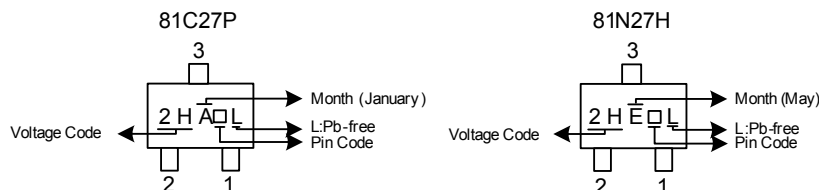

■ BLOCK DIAGRAM

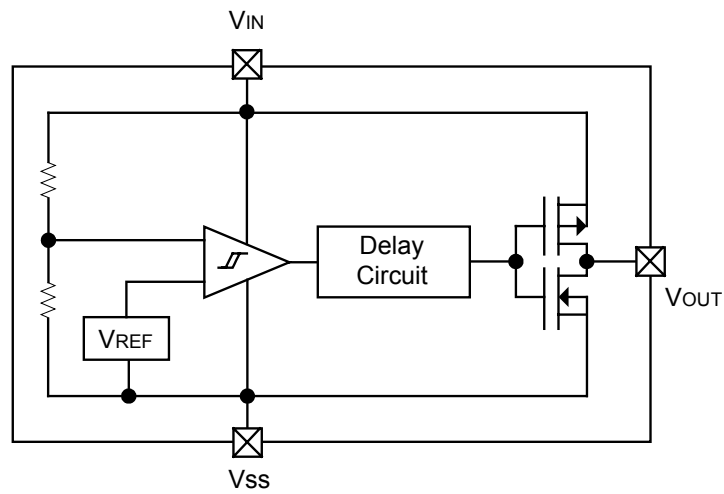

CMOS Output

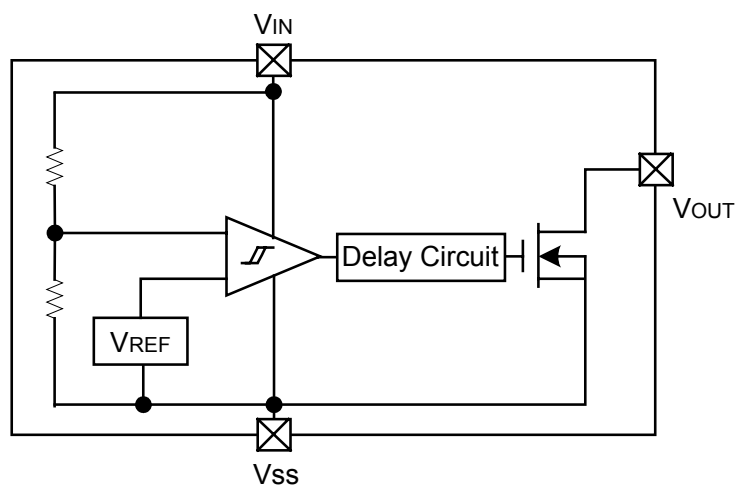

N-channel Open Drain Output

■ ABSOLUTE MAXIMUM RATINGS (Ta=25)

PARAMETER		SYMBOL	RATINGS	UNIT
Input Voltage		V _{IN}	12	V
Output Current		I _{OUT}	50	mA
Output Voltage	CMOS	V _{OUT}	V _{SS} -0.3 ~ V _{IN} +0.3	V
	N-Ch open drain		V _{SS} -0.3 ~ 9	
Power Dissipation	SOT-23	P _D	150	mW
	SOT-89		500	
	TO-92		300	
Operating Temperature		T _{OPR}	-30 ~ +80	
Storage Temperature		T _{STG}	-40 ~ +125	

Note Absolute maximum ratings are those values beyond which the device could be permanently damaged. Absolute maximum ratings are stress ratings only and functional device operation is not implied.

■ THERMAL DATA

PARAMETER		SYMBOL	RATINGS	UNIT
Thermal Resistance Junction-Case	SOT-23	J _C	200	/W
	SOT-89		100	
	TO-92		45	

■ ELECTRICAL CHARACTERISTICS (Ta=25)

Detection voltage (1.0V ~ 1.9V)

PARAMETER	SYMBOL	CIRCUIT	TEST CONDITIONS	MIN	TYP	MAX	UNIT
Detect Voltage	V _{DF}	1		V _{DF} (T) X0.98	V _{DF} (T)	V _{DF} (T) X1.02	V
Hysteresis Range	V _{HYS}	1		V _{DF} X0.02	V _{DF} X0.05	V _{DF} X0.08	V
Operating Voltage	V _{IN}	1	V _{DF} =1.6V ~ 6.0V	0.7		10.0	V
Supply Current	I _{SS}	2	V _{IN} =1.5V		0.9	2.6	μA
			V _{IN} =5.0		2.0	4.2	μA
Output Current	I _{OUT}	3	N-ch V _{DS} =0.5V, V _{IN} =1.0V		2.2		mA
		4	P-ch V _{DS} =2.1V, V _{IN} =8.0V (CMOS output)		-15.4		mA
V _{DF} Temperature Characteristics	$\frac{\Delta V_{DF}}{\Delta T_{OPR} \times V_{DF}}$				±100		ppm/
Transient Delay Time (V _{DR} → V _{OUT} inversion)	t _{DLY} *	5	V _{IN} changes from 0.6V ~ 10V	50		200	ms

■ ELECTRICAL CHARACTERISTICS(Cont.)

Detection voltage (2.0V ~ 2.9V)

PARAMETER	SYMBOL	CIRCUIT	TEST CONDITIONS	MIN	TYP	MAX	UNIT
Detect Voltage	V_{DF}	1		$V_{DF}(T)$ X0.98	$V_{DF}(T)$	$V_{DF}(T)$ X1.02	V
Hysteresis Range	V_{HYS}	1		V_{DF} X0.02	V_{DF} X0.05	V_{DF} X0.08	V
Operating Voltage	V_{IN}	1	$V_{DF}=1.6V \sim 6.0V$	0.7		10.0	V
Supply Current	I_{SS}	2	$V_{IN}=2.0V$		1.0	3.0	μA
			$V_{IN}=5.0V$		2.0	4.2	μA
Output Current	I_{OUT}	3	N-ch $V_{DS}=0.5V, V_{IN}=2.0V$		7.9		mA
		4	P-ch $V_{DS}=2.1V, V_{IN}=8.0V$ (CMOS output)		-15.4		mA
V_{DF} Temperature Characteristics	$\frac{\Delta V_{DF}}{\Delta T_{OPR} \times V_{DF}}$				± 100		ppm/
Transient Delay Time ($V_{DR} \rightarrow V_{OUT}$ inversion)	t_{DLY}^*	5	V_{IN} changes from 0.6V ~ 10V	50		200	ms

Detection voltage (3.0V ~ 3.9V)

PARAMETER	SYMBOL	CIRCUIT	TEST CONDITIONS	MIN	TYP	MAX	UNIT
Detect Voltage	V_{DF}	1		$V_{DF}(T)$ X0.98	$V_{DF}(T)$	$V_{DF}(T)$ X1.02	V
Hysteresis Range	V_{HYS}	1		V_{DF} X0.02	V_{DF} X0.05	V_{DF} X0.08	V
Operating Voltage	V_{IN}	1	$V_{DF}=1.6V \sim 6.0V$	0.7		10.0	V
Supply Current	I_{SS}	2	$V_{IN}=3.0V$		1.3	3.4	μA
			$V_{IN}=5.0V$		2.0	4.2	μA
Output Current	I_{OUT}	3	N-ch $V_{DS}=0.5V, V_{IN}=3.0V$		10.1		mA
		4	P-ch $V_{DS}=2.1V, V_{IN}=8.0V$ (CMOS output)		-15.4		mA
V_{DF} Temperature Characteristics	$\frac{\Delta V_{DF}}{\Delta T_{OPR} \times V_{DF}}$				± 100		ppm/
Transient Delay Time ($V_{DR} \rightarrow V_{OUT}$ inversion)	t_{DLY}^*	5	V_{IN} changes from 0.6V ~ 10V	50		200	ms

■ ELECTRICAL CHARACTERISTICS(Cont.)

Detection voltage (4.0V ~ 4.9V)

PARAMETER	SYMBOL	CIRCUIT	TEST CONDITIONS	MIN	TYP	MAX	UNIT
Detect Voltage	V_{DF}	1		$V_{DF}(T)$ X0.98	$V_{DF}(T)$	$V_{DF}(T)$ X1.02	V
Hysteresis Range	V_{HYS}	1		V_{DF} X0.02	V_{DF} X0.05	V_{DF} X0.08	V
Operating Voltage	V_{IN}	1	$V_{DF}=1.6V \sim 6.0V$	0.7		10.0	V
Supply Current	I_{SS}	2	$V_{IN}=4.0V$		1.5	3.8	μA
			$V_{IN}=5.0V$		2.0	4.2	μA
Output Current	I_{OUT}	3	N-ch $V_{DS}=0.5V, V_{IN}=4.0V$		11.5		mA
		4	P-ch $V_{DS}=2.1V, V_{IN}=8.0V$ (CMOS output)		-15.4		mA
V_{DF} Temperature Characteristics	$\frac{\Delta V_{DF}}{\Delta T_{OPR} \times V_{DF}}$				± 100		ppm/
Transient Delay Time ($V_{DR} \rightarrow V_{OUT}$ inversion)	t_{DLY}^*	5	V_{IN} changes from 0.6V ~ 10V	50		200	ms

Detection voltage (5.0V)

PARAMETER	SYMBOL	CIRCUIT	TEST CONDITIONS	MIN	TYP	MAX	UNIT
Detect Voltage	V_{DF}	1		$V_{DF}(T)$ X0.98	$V_{DF}(T)$	$V_{DF}(T)$ X1.02	V
Hysteresis Range	V_{HYS}	1		V_{DF} X0.02	V_{DF} X0.05	V_{DF} X0.08	V
Operating Voltage	V_{IN}	1	$V_{DF}=1.6V \sim 6.0V$	0.7		10.0	V
Supply Current	I_{SS}	2	$V_{IN}=5.0V$		2.0	4.2	μA
Output Current	I_{OUT}	3	N-ch $V_{DS}=0.5V, V_{IN}=5.0V$		13.0		mA
		4	P-ch $V_{DS}=2.1V, V_{IN}=8.0V$ (CMOS output)		-15.4		mA
V_{DF} Temperature Characteristics	$\frac{\Delta V_{DF}}{\Delta T_{OPR} \times V_{DF}}$				± 100		ppm/
Transient Delay Time ($V_{DR} \rightarrow V_{OUT}$ inversion)	t_{DLY}^*	5	V_{IN} changes from 0.6V ~ 10V	50		200	ms

$V_{DF}(T)$: established detect voltage value

Release Voltage: $V_{DR} = V_{DF} + V_{HYS}$

* Transient Delay Time: 1ms ~ 50ms & 200ms ~ 400ms versions are also available.

Note: The power consumption during power-start to output being stable (release operation) is 2 μA greater than it is after that period (completion of release operation) because of delay circuit through current.

TEST CIRCUITS

1-1

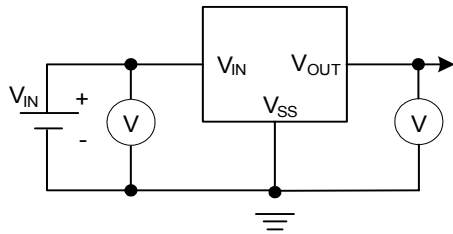

Cmos Output

1-2

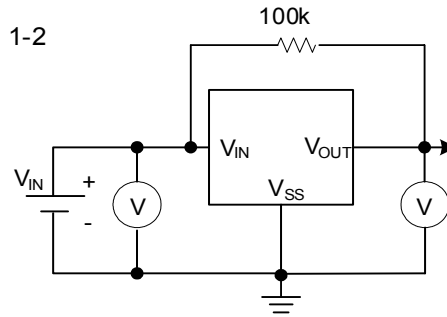

N-channel Open Drain Output

2

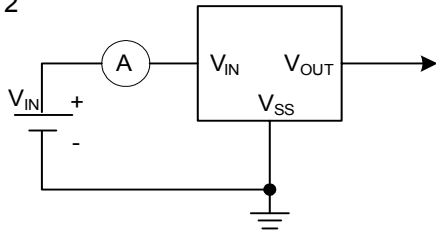

3

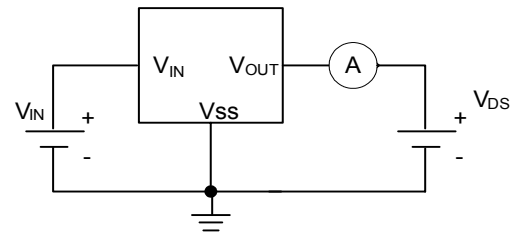

4

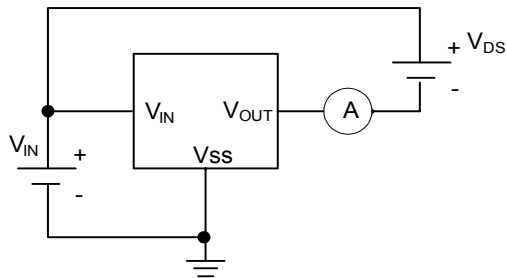

5-1

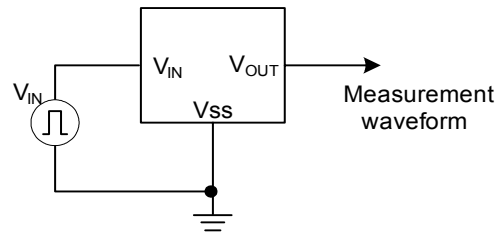

Cmos Output

5-2

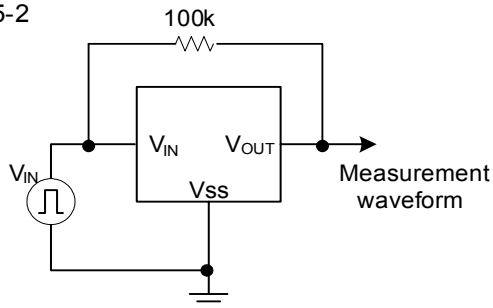

N-channel Open Drain Output

■ TYPICAL PERFORMANCE CHARACTERISTICS

(1) AMBIENT TEMPERATURE vs. TRANSIENT DELAY TIME

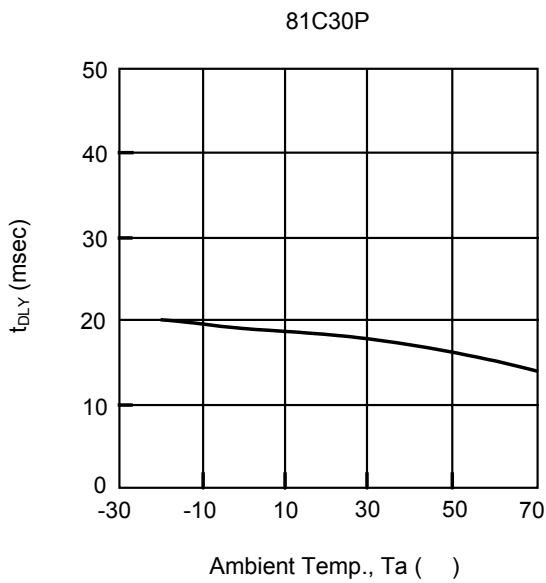
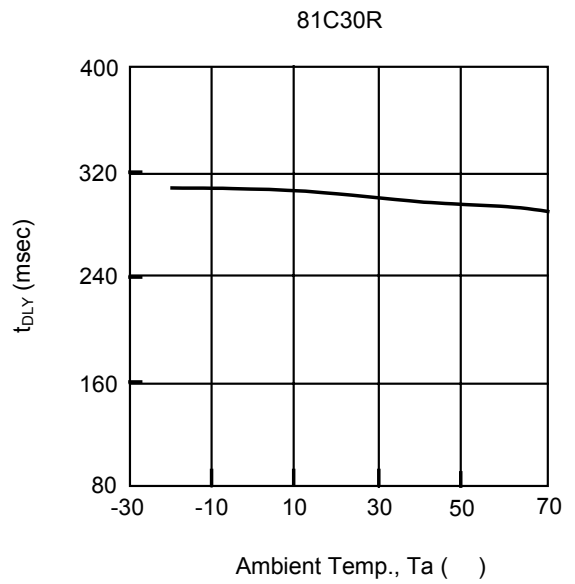
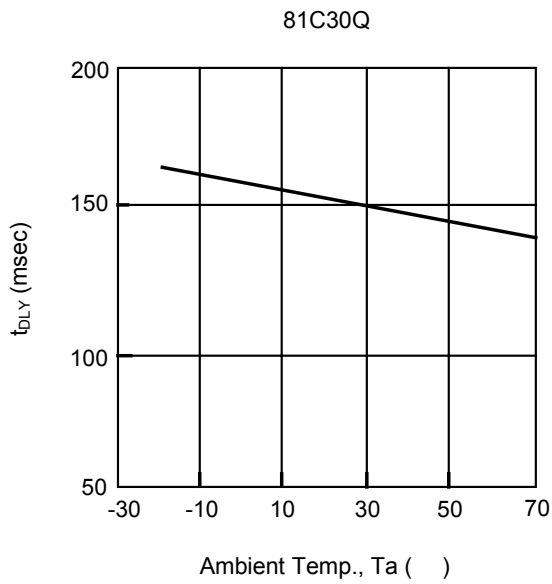

■ TYPICAL PERFORMANCE CHARACTERISTICS(Cont.)

(2) P-CHANNEL DRIVER OUTPUT CURRENT vs. INPUT VOLTAGE

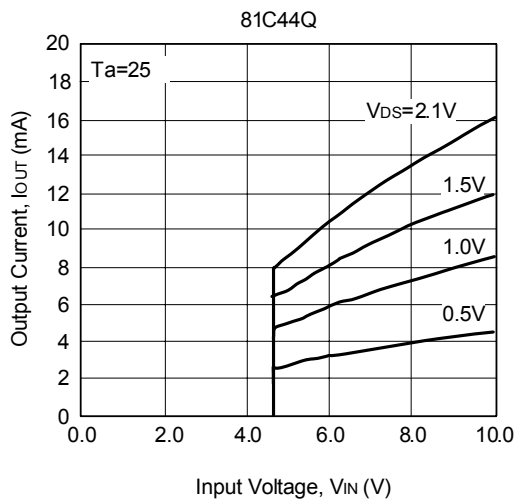
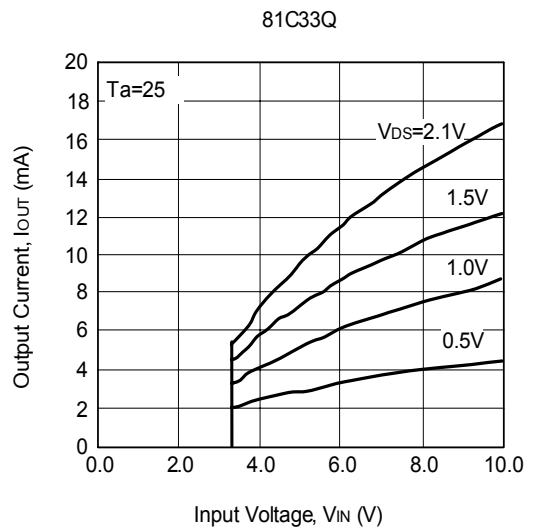
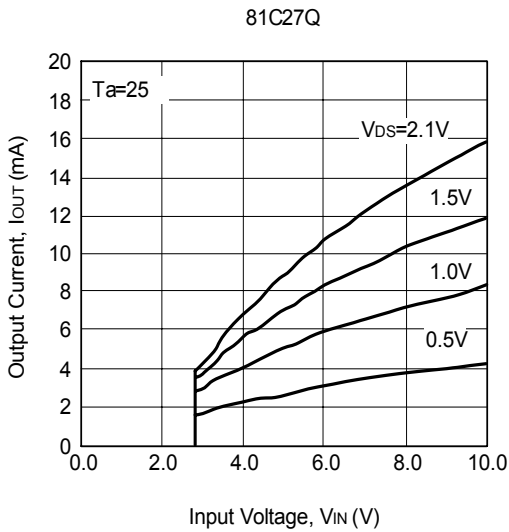

(2) TRANSIENT DELAY TIME vs. INPUT VOLTAGE

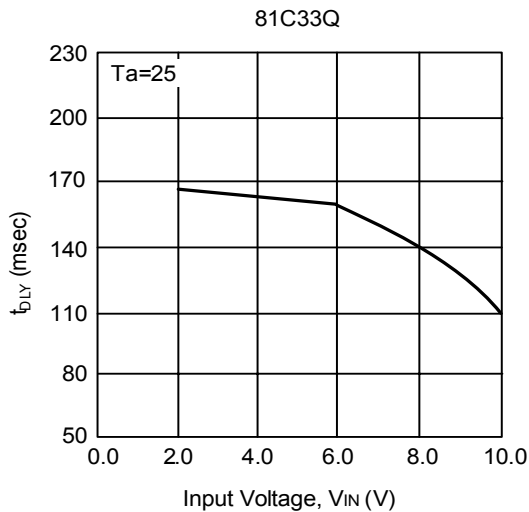

■ TYPICAL PERFORMANCE CHARACTERISTICS(Cont.)

(3) SUPPLY CURRENT vs. INPUT VOLTAGE

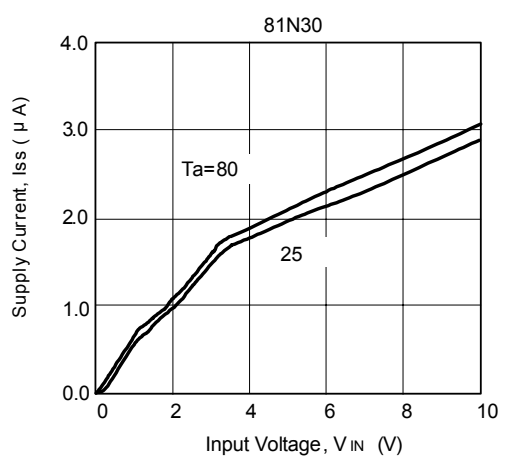
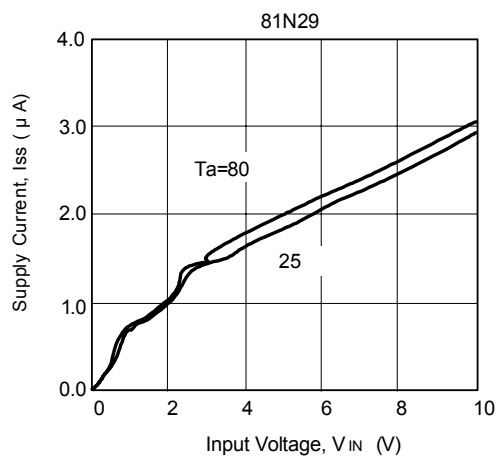
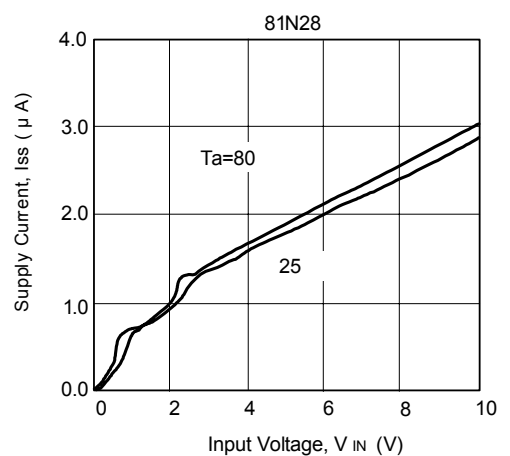
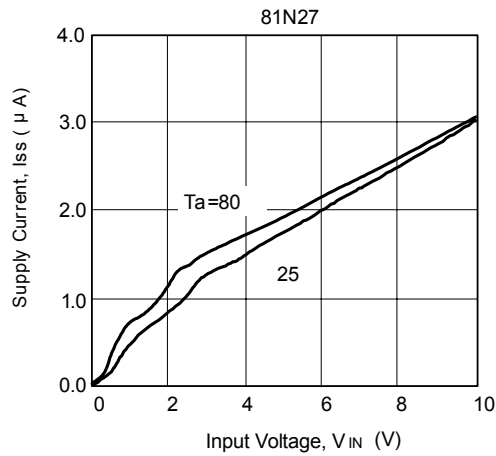
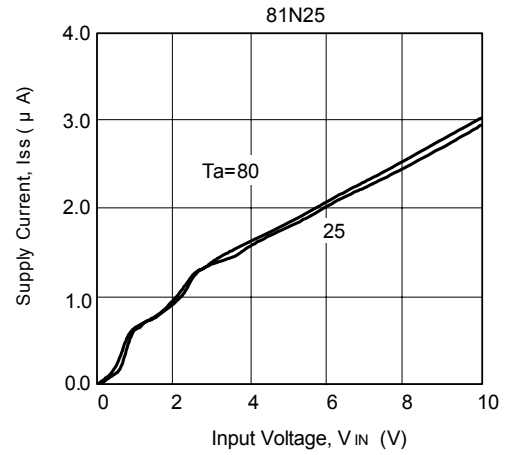
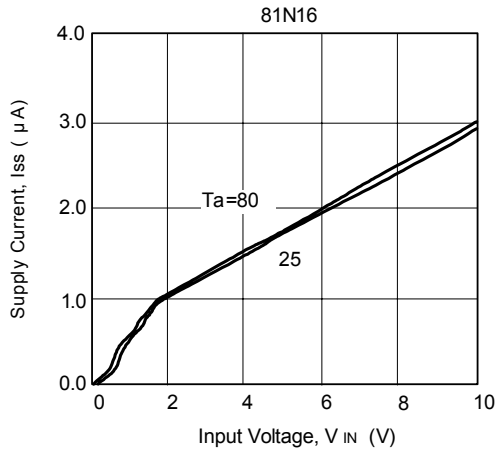

■ TYPICAL PERFORMANCE CHARACTERISTICS(Cont.)

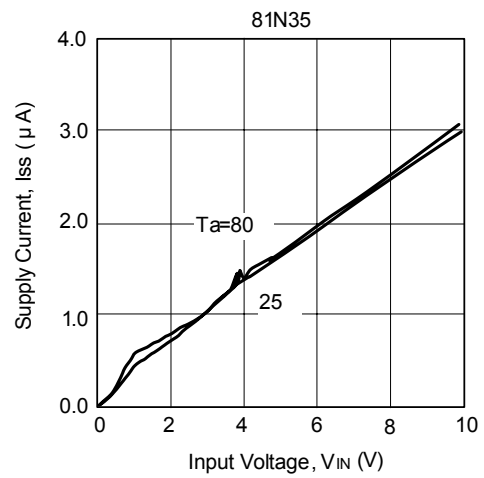
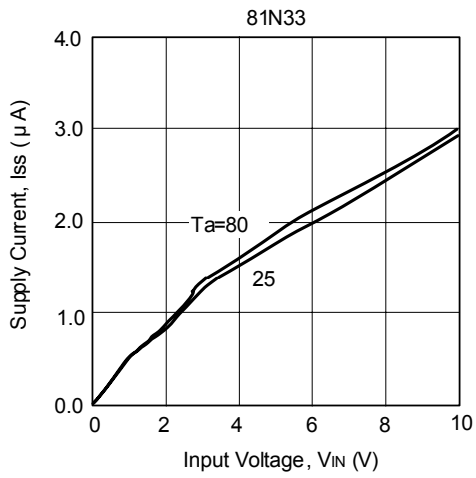

(4) OUTPUT VOLTAGE vs. INPUT VOLTAGE

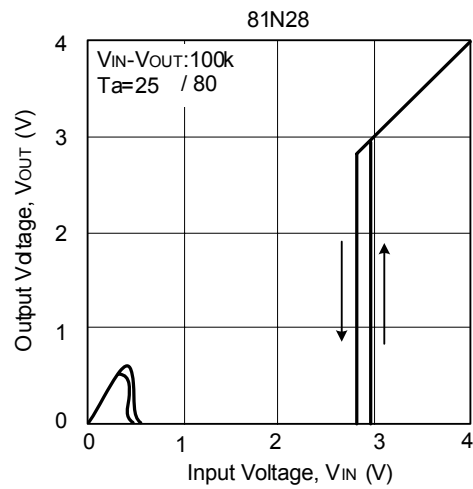
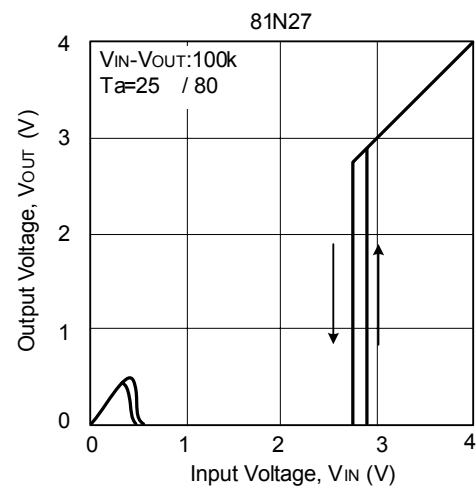
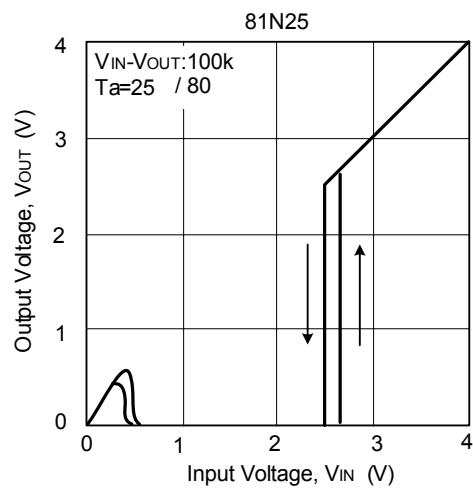
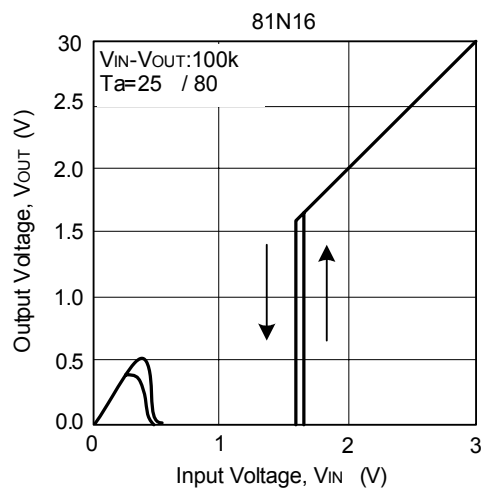

■ TYPICAL PERFORMANCE CHARACTERISTICS(Cont.)

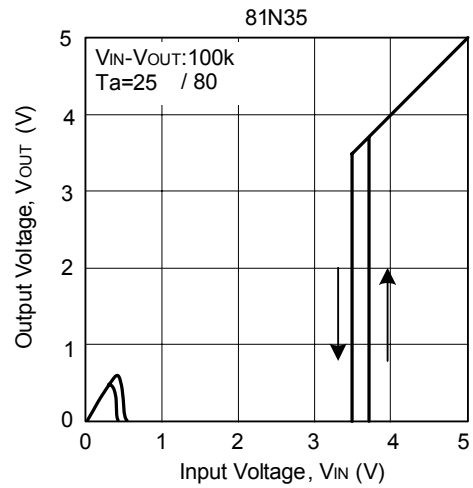
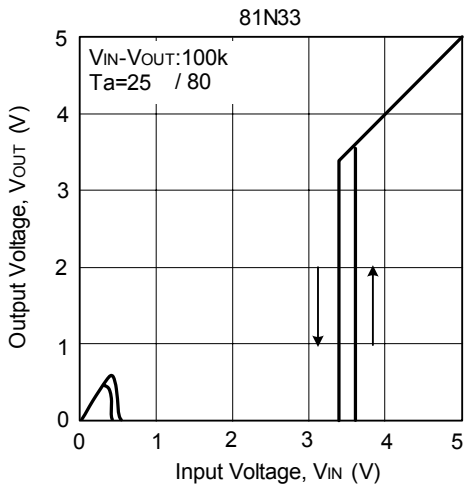
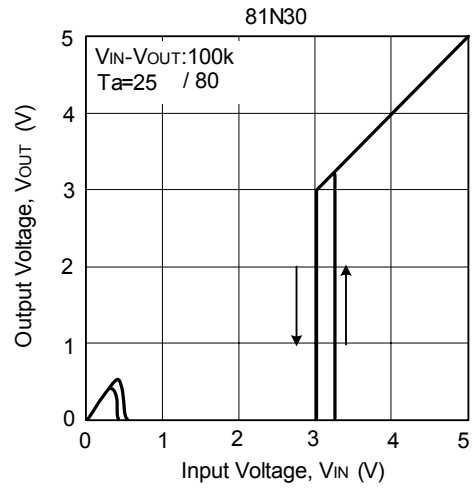
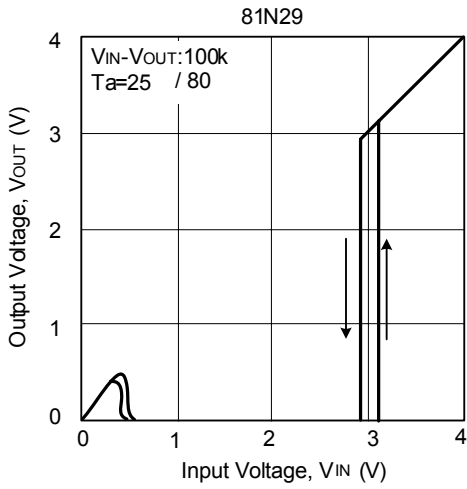

(5) N-CHANNEL DRIVRE OUTPUT CURRENT vs. V_{DS}

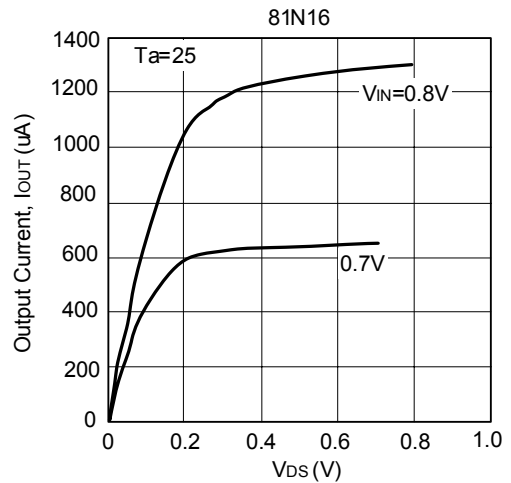
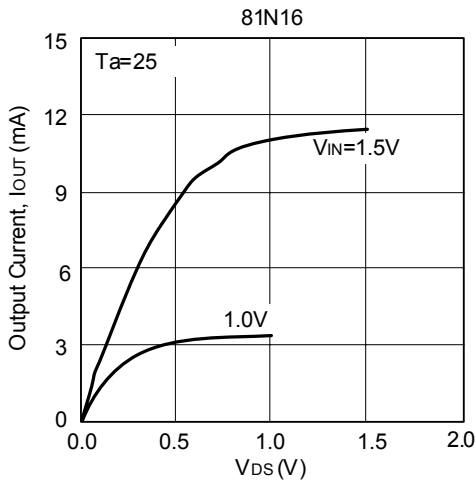

■ TYPICAL PERFORMANCE CHARACTERISTICS(Cont.)

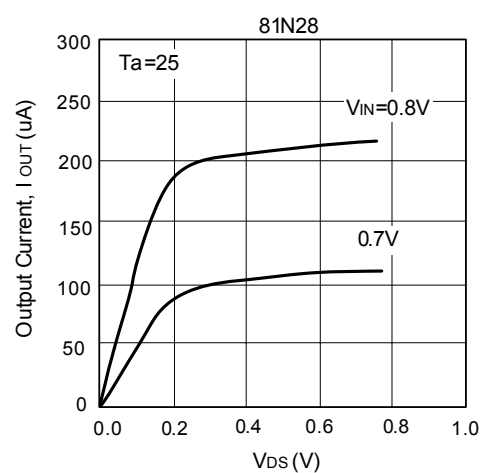
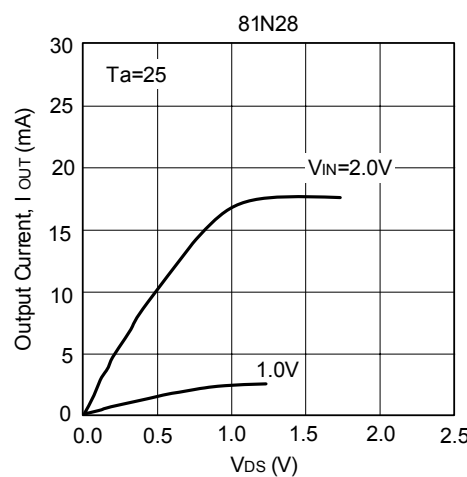
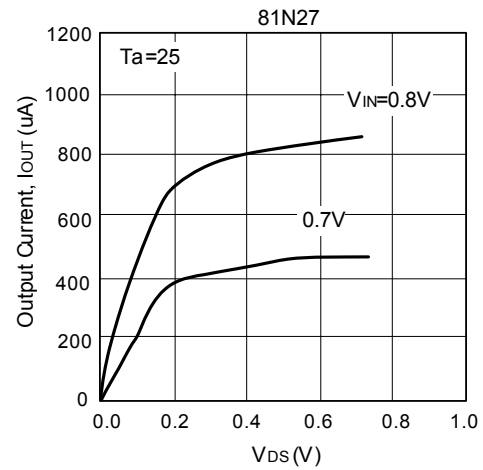
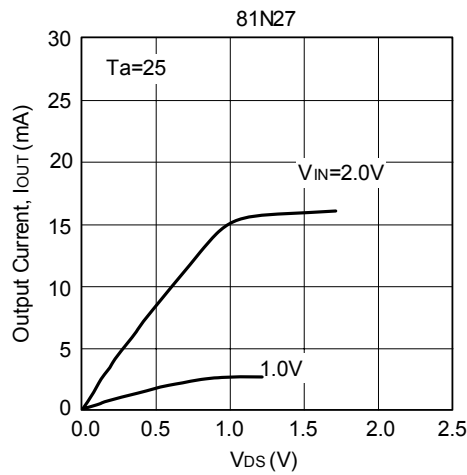
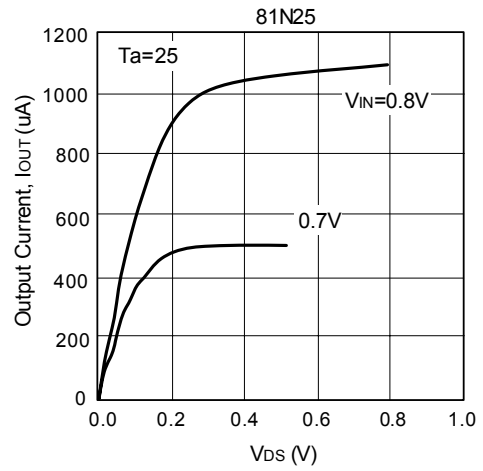
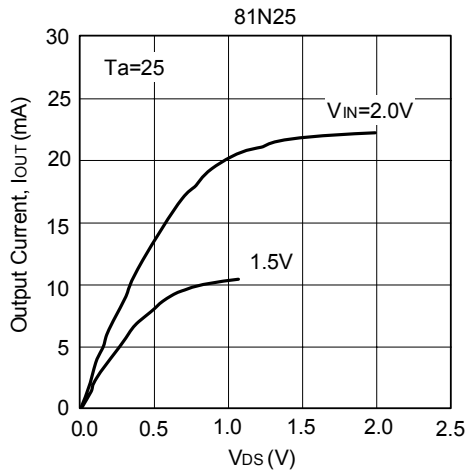

■ TYPICAL PERFORMANCE CHARACTERISTICS(Cont.)

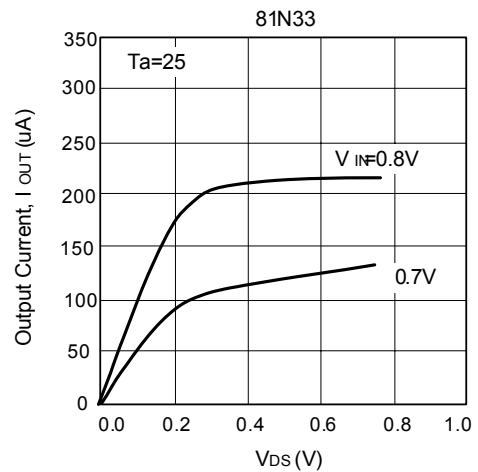
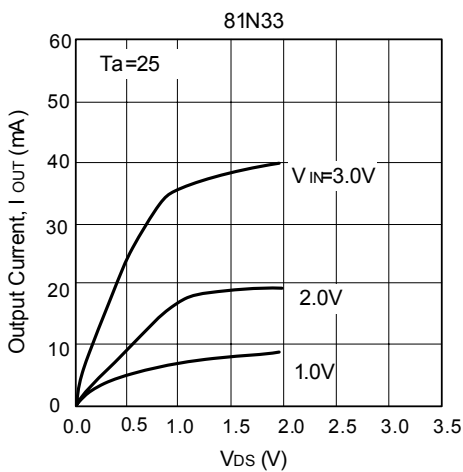
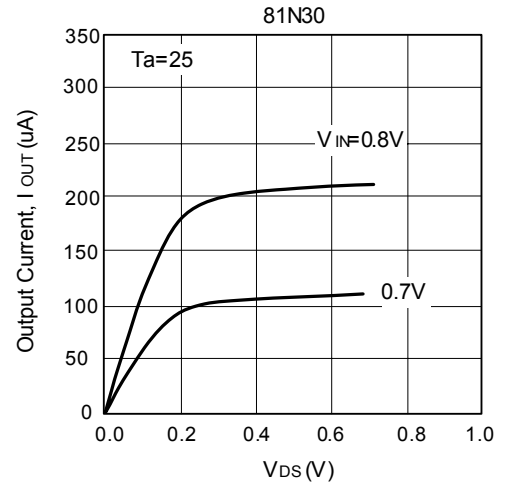
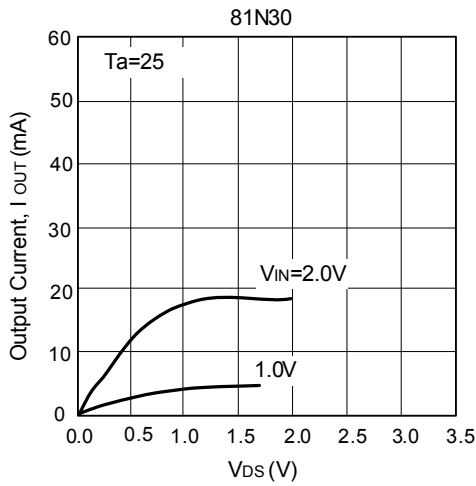
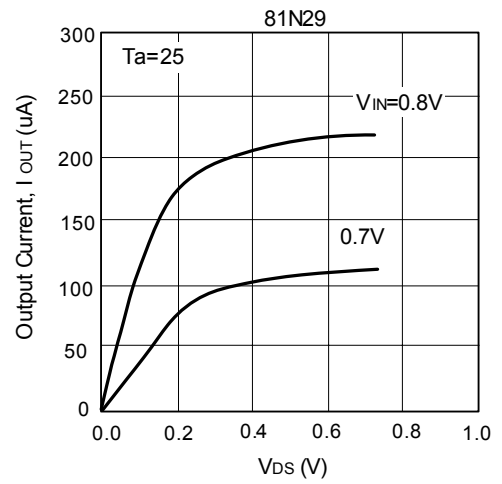
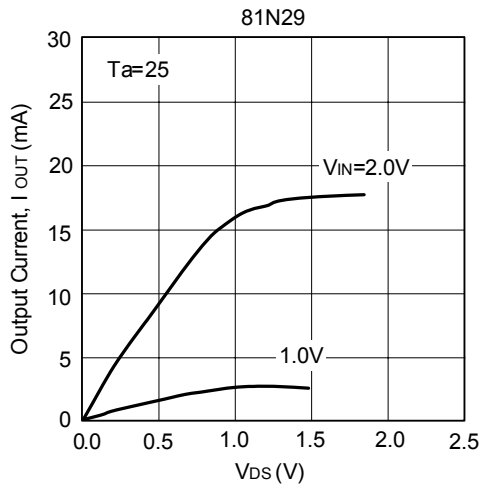

■ TYPICAL PERFORMANCE CHARACTERISTICS(Cont.)

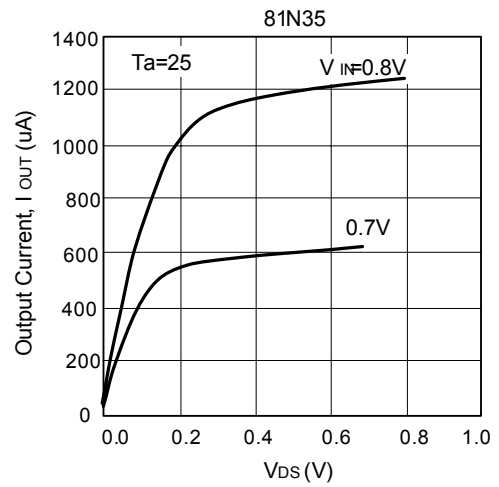
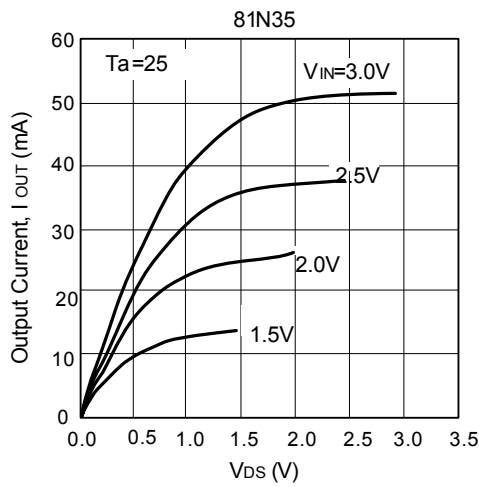

UTC assumes no responsibility for equipment failures that result from using products at values that exceed, even momentarily, rated values (such as maximum ratings, operating condition ranges, or other parameters) listed in products specifications of any and all UTC products described or contained herein. UTC products are not designed for use in life support appliances, devices or systems where malfunction of these products can be reasonably expected to result in personal injury. Reproduction in whole or in part is prohibited without the prior written consent of the copyright owner. The information presented in this document does not form part of any quotation or contract, is believed to be accurate and reliable and may be changed without notice.