

PLEASE CHECK WWW.MOLEX.COM FOR LATEST PART INFORMATION

Part Number: [15-31-1036](#)
Status: **Active**
Overview: Standard .093" Pin and Socket Connectors
Description: 2.36mm Diameter Standard .093" Pin and Socket Header, Vertical, with Beveled Plastic Peg, 3 Circuits

Documents:

[3D Model](#) [Test Summary TS-5219-002 \(PDF\)](#)
[Drawing \(PDF\)](#) [RoHS Certificate of Compliance \(PDF\)](#)
[Product Specification PS-3191-003 \(PDF\)](#)

Agency Certification

CSA LR19980
 UL E29179

General

Product Family PCB Headers
 Series [5219](#)
 Application Power, Wire-to-Board
 Overview [Standard .093" Pin and Socket Connectors](#)
 Product Name Standard .093"
 UPC 800753604551

Physical

Breakaway No
 Circuits (Loaded) 3
 Circuits (maximum) 3
 Color - Resin Natural
 Durability (mating cycles max) 30
 First Mate / Last Break No
 Flammability 94V-2
 Glow-Wire Compliant No
 Guide to Mating Part No
 Keying to Mating Part None
 Lock to Mating Part Yes
 Material - Plating Mating Tin
 Material - Plating Termination Tin
 Material - Resin Nylon
 Net Weight 2800.703/mg
 Number of Rows 1
 Orientation Vertical
 PCB Locator Yes
 PCB Retention Yes
 PCB Thickness - Recommended 1.60mm
 Packaging Type Bag
 Pitch - Mating Interface 6.70mm
 Polarized to PCB Yes
 Shrouded Fully
 Stackable No
 Surface Mount Compatible (SMC) No
 Temperature Range - Operating -40°C to +105°C
 Termination Interface: Style Through Hole

Electrical

Current - Maximum per Contact 11A
 Voltage - Maximum 600V

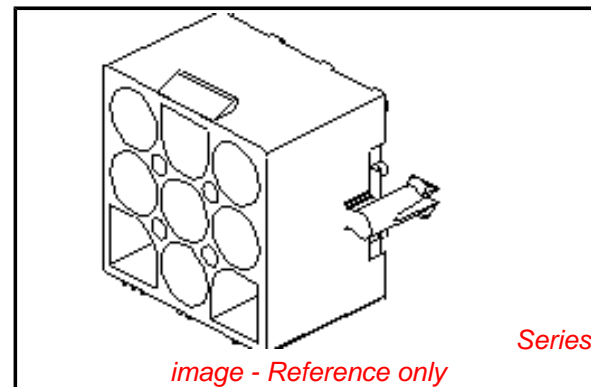

image - Reference only

EU RoHS

ELV and RoHS Compliant
REACH SVHC
Contains SVHC: No
Low-Halogen Status
Low-Halogen

China RoHS



Need more information on product environmental compliance?

Email productcompliance@molex.com
 For a multiple part number RoHS Certificate of Compliance, [click here](#)

Please visit the [Contact Us](#) section for any non-product compliance questions.

Search Parts in this Series

[5219Series](#)

Mates With

[3191 Pin and Socket Receptacle Housing](#)

Material Info

Old Part Number

5219-03A

Reference - Drawing Numbers

Product Specification

PS-3191-003, RPS-3191-002

Sales Drawing

SD-5219-03A-*

Test Summary

TS-5219-002

This document was generated on 04/03/2014

PLEASE CHECK WWW.MOLEX.COM FOR LATEST PART INFORMATION