

Single Cell Li-Ion Battery Fuel Gauge for Battery Pack Integration

Check for Samples: [bq27411-G1](#)

FEATURES

- **Single Series Cell Li-Ion Battery Fuel Gauge**
 - Resides in Battery Pack
 - Low-Value external Sense Resistor (10mΩ typical)
 - One Time Programmable (OTP) configuration Non-Volatile Memory (NVM)
 - Powered directly from battery with integrated LDO
 - 400-kHz I²C serial interface
 - Internal temperature sensor, or Host reported temperature
- **Easy to configure fuel gauging based on patented Impedance Track™ technology**
 - Reports Remaining Capacity and State of Charge (SOC) with Smoothing Filter
 - Automatically adjusts for battery aging, self-discharge, temperature, and rate changes
 - Battery State of Health (aging) estimation
- **Small 12-pin 2.5 mm × 4 mm SON Package**

APPLICATIONS

- Smartphones, Feature phones and Tablets
- Digital Still and Video Cameras
- Handheld Terminals
- MP3 or Multimedia Players

DESCRIPTION

The Texas Instruments bq27411-G1 is an easy to configure fuel gauging solution for single series cell Li-Ion battery packs. The device requires minimal configuration and uses One Time Programmable (OTP) Non-Volatile Memory (NVM) to avoid an initialization download by the system processor.

The bq27411-G1 uses the patented Impedance Track™ algorithm for fuel gauging, and provides information such as remaining battery capacity (mAh), state-of-charge (%), and battery voltage (mV).

The small 12-pin 2.5 mm × 4 mm SON package is ideal for space constrained applications.

TYPICAL APPLICATION

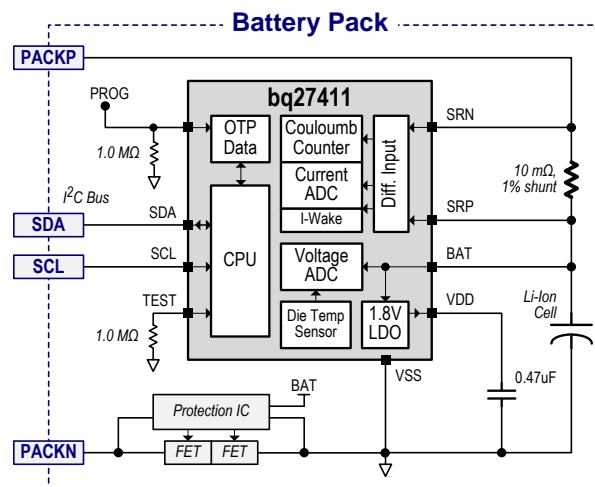

Please be aware that an important notice concerning availability, standard warranty, and use in critical applications of Texas Instruments semiconductor products and disclaimers thereto appears at the end of this data sheet.

Impedance Track is a trademark of Texas Instruments.



These devices have limited built-in ESD protection. The leads should be shorted together or the device placed in conductive foam during storage or handling to prevent electrostatic damage to the MOS gates.

DEVICE INFORMATION

AVAILABLE OPTIONS

| PART NUMBER | BATTERY TYPE | CHEM_ID (1) | DM_CODE (2) | FIRMWARE VERSION (3) | PACKAGE (4) | T _A | TAPE and REEL QUANTITY |
|-----------------|---|----------------|----------------|-------------------------|------------------------------|---------------------|------------------------|
| bq27411DRZR-G1A | LiCoO ₂ (4.2 V max charge) | 0x0128 | 0x80 | 1.09 (0x0109) | 12-pin, 2.5 x 4 mm SON | -40°C to 85°C | 3000 |
| bq27411DRZT-G1A | | | | | | | 250 |
| bq27411DRZR-G1B | LiMn ₂ O ₄ (4.3 V max charge) | 0x0312 | 0x90 | | | | 3000 |
| bq27411DRZT-G1B | | | | | | | 250 |
| bq27411DRZR-G1C | LiMn ₂ O ₄ (4.35 V max charge) | 0x0354 | 0xA0 | | | | 3000 |
| bq27411DRZT-G1C | | | | | | | 250 |

- (1) Refer to the CHEM_ID subcommand to confirm the battery chemistry type.
 (2) Refer to the DM_CODE subcommand to confirm the Data Memory code.
 (3) Refer to the FW_VERSION subcommand to confirm the firmware version.
 (4) For the most current package and ordering information see the Package Option Addendum at the end of this document; or, see the TI website at www.ti.com.

THERMAL INFORMATION

| THERMAL METRIC ⁽¹⁾ | | bq27411-G1 | UNITS |
|-------------------------------|--|---------------|-------|
| | | DRZ (12-PINS) | |
| θ_{JA} | Junction-to-ambient thermal resistance | 64.1 | °C/W |
| θ_{JcTop} | Junction-to-case (top) thermal resistance | 59.8 | |
| θ_{JB} | Junction-to-board thermal resistance | 52.7 | |
| ψ_{JT} | Junction-to-top characterization parameter | 0.3 | |
| ψ_{JB} | Junction-to-board characterization parameter | 28.3 | |
| θ_{JcBot} | Junction-to-case (bottom) thermal resistance | 2.4 | |

- (1) For more information about traditional and new thermal metrics, see the *IC Package Thermal Metrics* application report, [SPRA953](http://www.ti.com/lit/zip/Spra953).

PIN DIAGRAM AND PACKAGE DIMENSIONS

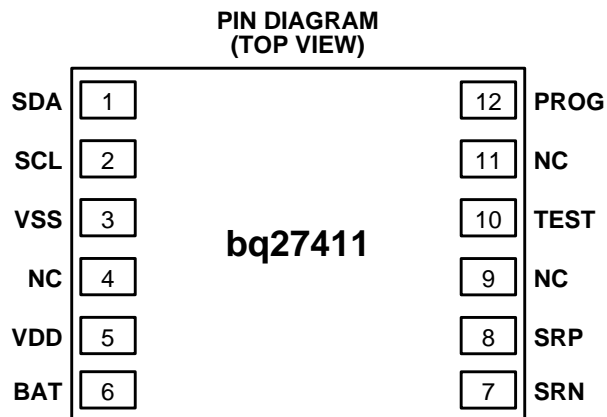

12-pin VSON, 2.5 x 4mm 0.4mm pitch

PIN FUNCTIONS

| PIN | | TYPE ⁽¹⁾ | DESCRIPTION |
|------|----------|---------------------|---|
| NAME | NO. | | |
| BAT | 6 | PI, AI | LDO regulator input, battery voltage input, and coulomb counter input typically connected to the PACK+ terminal. |
| VDD | 5 | PO | 1.8V Regulator Output. Decouple with 0.47µF ceramic capacitor to Vss. This pin is not intended to provide power for other devices in the system. |
| VSS | 3 | PI | Ground pin. |
| SRP | 8 | AI | Coulomb counter differential inputs expecting an external 10mΩ, 1% sense resistor. Connect SRP to BAT (CELLP) and connect SRN to PACKP. Refer to application diagram. |
| SRN | 7 | AI | |
| PROG | 12 | DO | Programming voltage input for the One Time Programmable (OTP) memory to be used during customer factory configuration. To avoid a floating input condition, recommend terminating with a 1.0MΩ (typical) pull-down resistor to VSS for reduced power consumption. |
| SDA | 1 | DIO | Slave I ² C serial bus for communication with system (Master). Open-drain pins. Use with external 5 - 10kΩ pull-up resistors (typical) for each pin. If the external pull-up resistors will be disconnected from these pins during normal operation, recommend using external 1.0MΩ pull-down resistors to VSS at each pin to avoid floating inputs. |
| SCL | 2 | DIO | |
| TEST | 10 | DI | This digital factory TEST pin must be pulled low for proper operation in customer's application. Recommend terminating with a 1.0MΩ (typical) pull-down resistor to VSS for reduced power consumption. |
| NC | 4, 8, 11 | -- | No internal connection. May be left floating or tied to VSS. |

(1) I/O = Digital input/output, IA = Analog input, P = Power connection

ELECTRICAL SPECIFICATIONS

ABSOLUTE MAXIMUM RATINGS

over operating free-air temperature range (unless otherwise noted)⁽¹⁾

| PARAMETER | | MIN | MAX | UNIT |
|-------------------|--|------|--------------------------|------|
| V _{BAT} | BAT pin input voltage range | -0.3 | 6 | V |
| V _{SR} | SRP and SRN pins input voltage range | -0.3 | [V _{BAT} + 0.3] | V |
| | Differential voltage across SRP and SRN. ABS(SRP - SRN). | | 2 | V |
| V _{DD} | VDD pin supply voltage range (LDO output) | -0.3 | 2 | V |
| V _{IOD} | Open-drain I/O pins (SDA, SCL) | -0.3 | 6 | V |
| V _{PROG} | PROG pin | -0.3 | 7.8 | V |
| V _{IOPP} | Push-Pull I/O pins (TEST) | -0.3 | [V _{DD} + 0.3] | V |
| T _A | Operating free-air temperature range | -40 | 85 | °C |
| T _{STG} | Storage temperature range | -65 | 150 | °C |

(1) Stresses beyond those listed under "absolute maximum ratings" may cause permanent damage to the device. These are stress ratings only, and functional operation of the device at these or any other conditions beyond those indicated under "recommended operating conditions" is not implied. Exposure to absolute-maximum-rated conditions for extended periods may affect device reliability.

RECOMMENDED OPERATING CONDITIONS

T_A = 30°C and V_{REGIN} = V_{BAT} = 3.6V (unless otherwise noted)

| PARAMETER | TEST CONDITIONS | MIN | TYP | MAX | UNIT |
|-----------------------------------|--|------|------|-----|------|
| C _{BAT} ⁽¹⁾ | External input capacitor for internal LDO between BAT and V _{SS} | | 0.1 | | μF |
| C _{LDO18} ⁽¹⁾ | External output capacitor for internal LDO between V _{DD} and V _{SS} | | 0.47 | | μF |
| V _{PU} ⁽¹⁾ | External pull-up voltage for open-drain pins (SDA, SCL, PROG) | 1.62 | | 3.6 | V |
| V _{PV} | PROG Programming Voltage [RA0] | 7.3 | 7.4 | 7.5 | V |
| I _{PV} | PROG Programming Current [RA0] | | 4 | 5 | mA |

(1) Specified by design. Not production tested.

SUPPLY CURRENT

T_A = 30°C and V_{REGIN} = V_{BAT} = 3.6V (unless otherwise noted)

| PARAMETER | TEST CONDITIONS | MIN | TYP | MAX | UNIT |
|----------------------------------|------------------------|-----|-----|-----|------|
| I _{CC} ⁽¹⁾ | NORMAL mode current | | 93 | | μA |
| I _{SLEP} ⁽¹⁾ | SLEEP mode current | | 21 | | μA |
| I _{HIB} ⁽¹⁾ | HIBERNATE mode current | | 9 | | μA |
| I _{SD} ⁽¹⁾ | SHUTDOWN mode current | | 0.6 | | μA |

(1) Specified by design. Not production tested.

(2) Wake Comparator Disabled.

DIGITAL INPUT AND OUTPUT DC CHARACTERISTICS

 $T_A = -40^{\circ}\text{C}$ to 85°C , typical values at $T_A = 30^{\circ}\text{C}$ and $V_{\text{REGIN}} = 3.6\text{ V}$ (unless otherwise noted)

| PARAMETER | TEST CONDITIONS | MIN | TYP | MAX | UNIT |
|-----------------------|---|----------------------------|-----|-----|---------------|
| $V_{\text{IH(OD)}}$ | Input voltage, high ⁽²⁾ External pullup resistor to V_{PU} | $V_{\text{PU}} \times 0.7$ | | | V |
| $V_{\text{IH(PP)}}$ | Input voltage, high ⁽³⁾ | 1.4 | | | V |
| V_{IL} | Input voltage, low ^{(2) (3)} | | | 0.6 | V |
| V_{OL} | Output voltage, low ⁽²⁾ | | | 0.6 | V |
| I_{OH} | Output source current, high ⁽²⁾ | | | 0.5 | mA |
| $I_{\text{OL(OD)}}$ | Output sink current, low ⁽²⁾ | | | -3 | mA |
| $C_{\text{IN}}^{(1)}$ | Input capacitance ^{(2) (3)} | | | 5 | pF |
| I_{Ikg} | SCL, SDA, and TEST pins | | | 0.1 | μA |
| | PROG pin | | | 1.0 | |

(1) Specified by design. Not production tested.

(2) Open Drain pins: (SCL, SDA, PROG)

(3) Push Pull pin: (TEST)

LDO REGULATOR, WAKE-UP AND AUTO-SHUTDOWN DC CHARACTERISTICS

 $T_A = -40^{\circ}\text{C}$ to 85°C , typical values at $T_A = 30^{\circ}\text{C}$ and $V_{\text{REGIN}} = 3.6\text{ V}$ (unless otherwise noted)

| PARAMETER | TEST CONDITIONS | MIN | TYP | MAX | UNIT |
|---------------------|---|------|------|-----|------|
| V_{BAT} | BAT pin regulator input | 2.45 | | 4.5 | V |
| V_{DD} | Regulator output voltage | | 1.8 | | V |
| $UVLO_{\text{IT+}}$ | V_{BAT} Under Voltage Lock Out LDO Wake-Up Rising Threshold | | 2 | | V |
| $UVLO_{\text{IT-}}$ | V_{BAT} Under Voltage Lock Out LDO Auto-Shutdown Falling Threshold | | 1.95 | | V |

(1) Specified by design. Not production tested.

ADC (TEMPERATURE AND CELL MEASUREMENT) CHARACTERISTICS

 $T_A = -40^{\circ}\text{C}$ to 85°C ; typical values at $T_A = 30^{\circ}\text{C}$ and $V_{\text{REGIN}} = 3.6\text{ V}$ (unless otherwise noted)

| PARAMETER | TEST CONDITIONS | MIN | TYP | MAX | UNIT |
|------------------------|---|------|-----|-----|------|
| $V_{\text{IN(BAT)}}$ | BAT pin voltage measurement range. Voltage divider enabled. | 2.45 | | 4.5 | V |
| $t_{\text{ADC_CONV}}$ | Conversion time | | 125 | | ms |
| | Effective Resolution | | 15 | | bits |

(1) Specified by design. Not tested in production.

INTEGRATING ADC (COULOMB COUNTER) CHARACTERISTICS

 $T_A = -40^{\circ}\text{C}$ to 85°C ; typical values at $T_A = 30^{\circ}\text{C}$ and $V_{\text{REGIN}} = 3.6\text{ V}$ (unless otherwise noted)

| PARAMETER | TEST CONDITIONS | MIN | TYP | MAX | UNIT |
|-----------------------|---|-----|--------------|-----|------|
| V_{SR} | Input voltage range from BAT to SRX pins | | BAT \pm 25 | | mV |
| $t_{\text{SR_CONV}}$ | Conversion time | | 1 | | s |
| | Effective Resolution | | 16 | | bits |

(1) Specified by design. Not tested in production.

I²C-COMPATIBLE INTERFACE COMMUNICATION TIMING CHARACTERISTICS

T_A = -40°C to 85°C; typical values at T_A = 30°C and V_{REGIN} = 3.6 V (unless otherwise noted)

| PARAMETER | TEST CONDITIONS | MIN | TYP | MAX | UNIT |
|--------------------------------|--------------------------------------|-------------------------------|-----|-----|------|
| Standard Mode (100 kHz) | | | | | |
| t _{d(STA)} | Start to first falling edge of SCL | 4 | | | μs |
| t _{w(L)} | SCL pulse duration (low) | 4.7 | | | μs |
| t _{w(H)} | SCL pulse duration (high) | 4 | | | μs |
| t _{su(STA)} | Setup for repeated start | 4.7 | | | μs |
| t _{su(DAT)} | Data setup time | Host drives SDA | | | ns |
| t _{h(DAT)} | Data hold time | Host drives SDA | | | ns |
| t _{su(STOP)} | Setup time for stop | 4 | | | μs |
| t _(BUF) | Bus free time between stop and start | Includes Command Waiting Time | | 66 | μs |
| t _f | SCL/SDA fall time ⁽¹⁾ | | | 300 | ns |
| t _r | SCL/SDA rise time ⁽¹⁾ | | | 300 | ns |
| f _{SCL} | Clock frequency ⁽²⁾ | | | 100 | kHz |
| Fast Mode (400 kHz) | | | | | |
| t _{d(STA)} | Start to first falling edge of SCL | 600 | | | ns |
| t _{w(L)} | SCL pulse duration (low) | 1300 | | | ns |
| t _{w(H)} | SCL pulse duration (high) | 600 | | | ns |
| t _{su(STA)} | Setup for repeated start | 600 | | | ns |
| t _{su(DAT)} | Data setup time | Host drives SDA | | 100 | ns |
| t _{h(DAT)} | Data hold time | Host drives SDA | | 0 | ns |
| t _{su(STOP)} | Setup time for stop | 600 | | | ns |
| t _(BUF) | Bus free time between stop and start | Includes Command Waiting Time | | 66 | μs |
| t _f | SCL/SDA fall time ⁽¹⁾ | | | 300 | ns |
| t _r | SCL/SDA rise time ⁽¹⁾ | | | 300 | ns |
| f _{SCL} | Clock frequency ⁽²⁾ | | | 400 | kHz |

- (1) Specified by design. Not production tested.
- (2) If the clock frequency (f_{SCL}) is > 100 kHz, use 1-byte write commands for proper operation. All other transactions types are supported at 400 kHz. (Refer to [I²C INTERFACE](#) and [I²C Command Waiting Time](#))

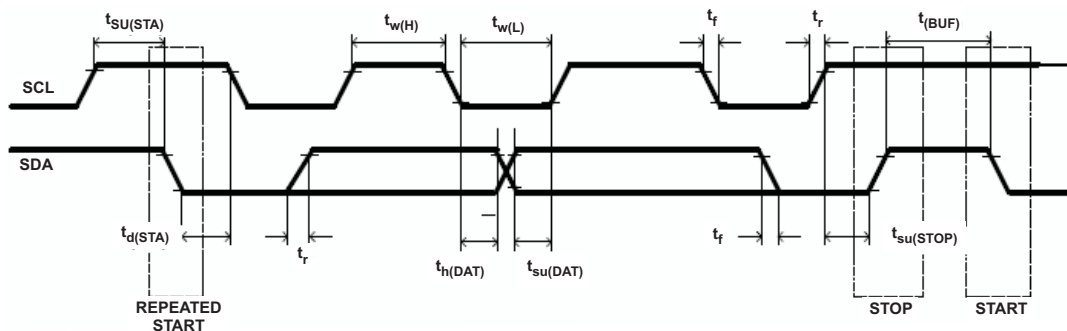

Figure 1. I²C-Compatible Interface Timing Diagrams

GENERAL DESCRIPTION

The bq27411-G1 accurately predicts the battery capacity and other operational characteristics of a single Li-based rechargeable cell. It can be interrogated by a system processor to provide cell information, such as state-of-charge (SOC). The bq27411-G1 is available in several options optimized for different battery cell chemistries. (See [AVAILABLE OPTIONS](#) table.) Configuration parameters unique to the customer's application are programmed in OTP memory at the customer's factory using a 7.4V typical voltage applied to the PROG pin and a set of I²C programming commands. More details are available in the [SmartFlash OTP Programming \(SLUA703\)](#) document.

Information is accessed through a series of commands, called *Standard Commands*. Further capabilities are provided by the additional *Extended Commands* set. Both sets of commands, indicated by the general format *Command()*, are used to read and write information contained within the bq27411-G1 control and status registers, as well as its data locations.

The key to the bq27411-G1's high-accuracy gas gauging prediction is Texas Instrument's proprietary Impedance Track™ algorithm. This algorithm uses cell measurements, characteristics, and properties to create state-of-charge predictions that can achieve high accuracy across a wide variety of operating conditions and over the lifetime of the battery.

The bq27411-G1 measures charge/discharge activity by monitoring the voltage across a small-value sense resistor. When a cell is attached to the bq27411-G1, cell impedance is computed, based on cell current, cell open-circuit voltage (OCV), and cell voltage under loading conditions.

The bq27411-G1 uses an integrated temperature sensor for estimating cell temperature. Alternatively, the host processor can provide temperature data for the bq27411-G1.

To minimize power consumption, the bq27411-G1 has several power modes: INITIALIZATION, NORMAL, SLEEP, and HIBERNATE. The bq27411-G1 passes automatically between these modes, depending upon the occurrence of specific events, though a system processor can initiate some of these modes directly. More details are found in the [bq27411-G1 Technical Reference Manual \(SLUJAS7\)](#).

NOTE

Formatting Conventions in this Document:

Commands: *italics* with parentheses() and no breaking spaces, for example, *RemainingCapacity()*.

Data Flash: *italics*, **bold**, and breaking spaces, for example, ***Design Capacity***.

Register bits and flags: *italics* with brackets [], for example, *[TDA]*

Data flash bits: *italics*, **bold**, and brackets [], for example, ***[LED1]***

Modes and states: ALL CAPITALS, for example, UNSEALED mode.

DATA COMMANDS

STANDARD DATA COMMANDS

The bq27411-G1 uses a series of 2-byte standard commands to enable system reading and writing of battery information. Each standard command has an associated command-code pair, as indicated in . Because each command consists of two bytes of data, two consecutive I²C transmissions must be executed both to initiate the command function, and to read or write the corresponding two bytes of data. Additional details are found in the [bq27411-G1 Technical Reference Manual \(SLUJAS7\)](#).

Table 1. Standard Commands

| NAME | | COMMAND CODE | UNITS | SEALED ACCESS |
|------------------------------------|-------|--------------|---------|---------------|
| <i>Control()</i> | CNTL | 0x00 / 0x01 | N/A | R/W |
| <i>Temperature()</i> | TEMP | 0x02 / 0x03 | 0.1°K | R/W |
| <i>Voltage()</i> | VOLT | 0x04 / 0x05 | mV | R |
| <i>Flags()</i> | FLAGS | 0x06 / 0x07 | N/A | R |
| <i>NominalAvailableCapacity()</i> | | 0x08 / 0x09 | mAh | R |
| <i>FullAvailableCapacity()</i> | | 0x0a / 0x0b | mAh | R |
| <i>RemainingCapacity()</i> | RM | 0x0c / 0x0d | mAh | R |
| <i>FullChargeCapacity()</i> | FCC | 0x0e / 0x0f | mAh | R |
| <i>AverageCurrent()</i> | | 0x10 / 0x11 | mA | R |
| <i>StandbyCurrent()</i> | | 0x12 / 0x13 | mA | R |
| <i>MaxLoadCurrent()</i> | | 0x14 / 0x15 | mA | R |
| <i>AveragePower()</i> | | 0x18 / 0x19 | mW | R |
| <i>StateOfCharge()</i> | SOC | 0x1c / 0x1d | % | R |
| <i>IntTemperature()</i> | | 0x1e / 0x1f | 0.1°K | R |
| <i>StateOfHealth()</i> | SOH | 0x20 / 0x21 | num / % | R |

Control(): 0x00/0x01

Issuing a *Control()* command requires a subsequent 2-byte subcommand. These additional bytes specify the particular control function desired. The *Control()* command allows the system to control specific features of the bq27411-G1 during normal operation and additional features when the device is in different access modes, as described in . Additional details are found in the [bq27411-G1 Technical Reference Manual \(SLUUAS7\)](#).

Table 2. Control() Subcommands

| CNTL FUNCTION | CNTL DATA | SEALED ACCESS | DESCRIPTION |
|-----------------|-----------|---------------|---|
| CONTROL_STATUS | 0x0000 | Yes | Reports the status of device. |
| DEVICE_TYPE | 0x0001 | Yes | Reports the device type (0x0421). |
| FW_VERSION | 0x0002 | Yes | Reports the firmware version of the device. |
| DM_CODE | 0x0004 | Yes | Reports the Data Memory Code number stored in NVM. |
| PREV_MACWRITE | 0x0007 | Yes | Returns previous MAC command code. |
| CHEM_ID | 0x0008 | Yes | Reports the chemical identifier of the Impedance Track™ configuration |
| SET_HIBERNATE | 0x0011 | Yes | Forces CONTROL_STATUS [<i>HIBERNATE</i>] to 1. |
| CLEAR_HIBERNATE | 0x0012 | Yes | Forces CONTROL_STATUS [<i>HIBERNATE</i>] to 0. |
| SET_CFGUPDATE | 0x0013 | No | Force CONTROL_STATUS [<i>CFGUPMODE</i>] to 1 and gauge enters CONFIG UPDATE mode. |
| SEALED | 0x0020 | No | Places the device in SEALED access mode. |
| RESET | 0x0041 | No | Performs a full device reset. |
| SOFT_RESET | 0x0042 | No | Gauge exits CONFIG UPDATE mode. |

FUNCTIONAL DESCRIPTION

I²C INTERFACE

The bq27411-G1 supports the standard I²C read, incremental read, quick read, one-byte write, and incremental write functions. The 7-bit device address (ADDR) is the most significant 7 bits of the hex address and is fixed as 1010101. The first 8 bits of the I²C protocol are, therefore, 0xAA or 0xAB for write or read, respectively.

Host generated Gauge generated



(a) 1-byte write

(b) quick read

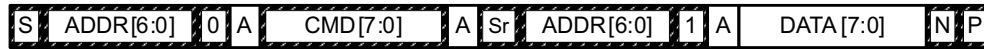

(c) 1- byte read

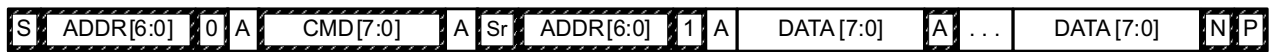

(d) incremental read



(e) incremental write

(S = Start, Sr = Repeated Start, A = Acknowledge, N = No Acknowledge, and P = Stop).

The quick read returns data at the address indicated by the address pointer. The address pointer, a register internal to the I²C communication engine, increments whenever data is acknowledged by the bq27411-G1 or the I²C master. “Quick writes” function in the same manner and are a convenient means of sending multiple bytes to consecutive command locations (such as two-byte commands that require two bytes of data).

The following command sequences are not supported:

Attempt to write a read-only address (NACK after data sent by master):

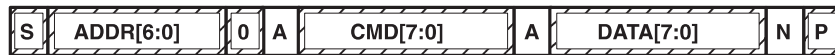

Attempt to read an address above 0x6B (NACK command):



I²C Time Out

The I²C engine releases both SDA and SCL if the I²C bus is held low for 2 seconds. If the bq27411-G1 is holding the lines, releasing them frees them for the master to drive the lines. If an external condition is holding either of the lines low, the I²C engine enters the low-power sleep mode.

I²C Command Waiting Time

To ensure proper operation at 400 kHz, a $t_{(BUF)} \geq 66 \mu s$ bus-free waiting time must be inserted between all packets addressed to the bq27411-G1. In addition, if the SCL clock frequency (f_{SCL}) is > 100 kHz, use individual 1-byte write commands for proper data flow control. The following diagram shows the standard waiting time required between issuing the control subcommand and the reading the status result. For read-write standard command, a minimum of 2 seconds is required to get the result updated. For read-only standard commands, there is no waiting time required, but the host must not issue any standard command more than two times per second. Otherwise, the gauge could result in a reset issue due to the expiration of the watchdog timer.

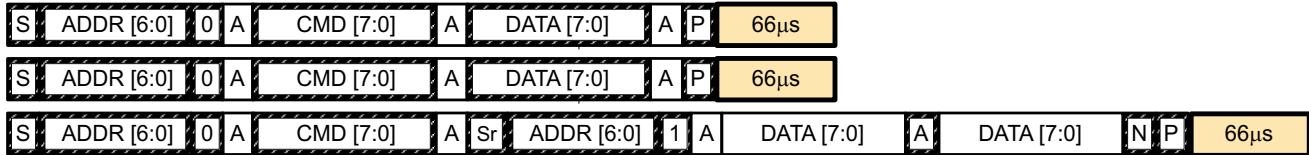

Waiting time inserted between two 1-byte write packets for a subcommand and reading results
(required for $100 \text{ kHz} < f_{SCL} \leq 400 \text{ kHz}$)

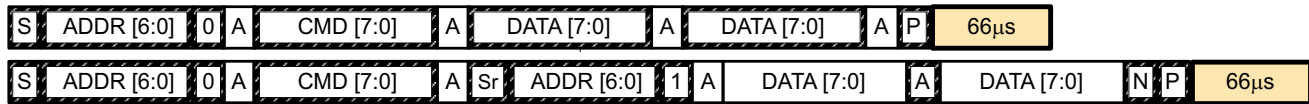

Waiting time inserted between incremental 2-byte write packet for a subcommand and reading results
(acceptable for $f_{SCL} \leq 100 \text{ kHz}$)

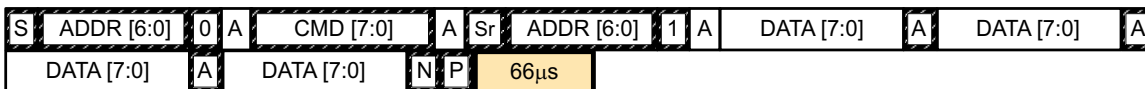

Waiting time inserted after incremental read

I²C Clock Stretching

A clock stretch can occur during all modes of fuel gauge operation. In SLEEP and HIBERNATE modes, a short $\leq 100 \mu s$ clock stretch occurs on all I²C traffic as the device must wake-up to process the packet. In the other modes (INITIALIZATION , NORMAL) a ≤ 4 ms clock stretching period may occur within packets addressed for the fuel gauge as the I²C interface performs normal data flow control.

REFERENCE SCHEMATIC

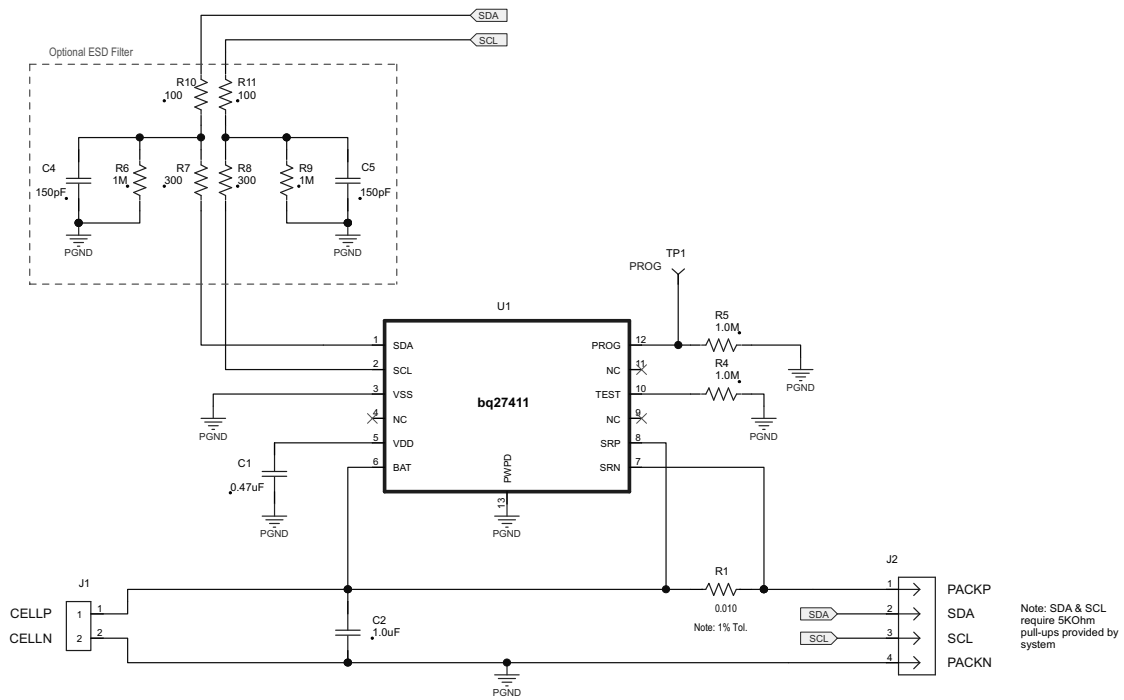

PACKAGING INFORMATION

| Orderable Device | Status (1) | Package Type | Package Drawing | Pins | Package Qty | Eco Plan (2) | Lead/Ball Finish (6) | MSL Peak Temp (3) | Op Temp (°C) | Device Marking (4/5) | Samples |
|------------------|---------------|--------------|-----------------|------|-------------|-------------------------|-------------------------|----------------------|--------------|-------------------------|-------------------------|
| BQ27411DRZ-G1A | PREVIEW | SON | DRZ | 12 | | TBD | Call TI | Call TI | -40 to 85 | | |
| BQ27411DRZ-G1C | PREVIEW | SON | DRZ | 12 | | TBD | Call TI | Call TI | -40 to 85 | | |
| BQ27411DRZR-G1A | ACTIVE | SON | DRZ | 12 | 3000 | Green (RoHS & no Sb/Br) | CU NIPDAU | Level-2-260C-1 YEAR | -40 to 85 | BQ27 411A | Samples |
| BQ27411DRZR-G1C | ACTIVE | SON | DRZ | 12 | 3000 | Green (RoHS & no Sb/Br) | CU NIPDAU | Level-2-260C-1 YEAR | -40 to 85 | BQ27 411C | Samples |
| BQ27411DRZT-G1A | ACTIVE | SON | DRZ | 12 | 250 | Green (RoHS & no Sb/Br) | CU NIPDAU | Level-2-260C-1 YEAR | -40 to 85 | BQ27 411A | Samples |
| BQ27411DRZT-G1C | ACTIVE | SON | DRZ | 12 | 250 | Green (RoHS & no Sb/Br) | CU NIPDAU | Level-2-260C-1 YEAR | -40 to 85 | BQ27 411C | Samples |

(1) The marketing status values are defined as follows:

ACTIVE: Product device recommended for new designs.

LIFEBUY: TI has announced that the device will be discontinued, and a lifetime-buy period is in effect.

NRND: Not recommended for new designs. Device is in production to support existing customers, but TI does not recommend using this part in a new design.

PREVIEW: Device has been announced but is not in production. Samples may or may not be available.

OBSELETE: TI has discontinued the production of the device.

(2) Eco Plan - The planned eco-friendly classification: Pb-Free (RoHS), Pb-Free (RoHS Exempt), or Green (RoHS & no Sb/Br) - please check <http://www.ti.com/productcontent> for the latest availability information and additional product content details.

TBD: The Pb-Free/Green conversion plan has not been defined.

Pb-Free (RoHS): TI's terms "Lead-Free" or "Pb-Free" mean semiconductor products that are compatible with the current RoHS requirements for all 6 substances, including the requirement that lead not exceed 0.1% by weight in homogeneous materials. Where designed to be soldered at high temperatures, TI Pb-Free products are suitable for use in specified lead-free processes.

Pb-Free (RoHS Exempt): This component has a RoHS exemption for either 1) lead-based flip-chip solder bumps used between the die and package, or 2) lead-based die adhesive used between the die and leadframe. The component is otherwise considered Pb-Free (RoHS compatible) as defined above.

Green (RoHS & no Sb/Br): TI defines "Green" to mean Pb-Free (RoHS compatible), and free of Bromine (Br) and Antimony (Sb) based flame retardants (Br or Sb do not exceed 0.1% by weight in homogeneous material)

(3) MSL, Peak Temp. - The Moisture Sensitivity Level rating according to the JEDEC industry standard classifications, and peak solder temperature.

(4) There may be additional marking, which relates to the logo, the lot trace code information, or the environmental category on the device.

(5) Multiple Device Markings will be inside parentheses. Only one Device Marking contained in parentheses and separated by a "~" will appear on a device. If a line is indented then it is a continuation of the previous line and the two combined represent the entire Device Marking for that device.

⁽⁶⁾ Lead/Ball Finish - Orderable Devices may have multiple material finish options. Finish options are separated by a vertical ruled line. Lead/Ball Finish values may wrap to two lines if the finish value exceeds the maximum column width.

Important Information and Disclaimer:The information provided on this page represents TI's knowledge and belief as of the date that it is provided. TI bases its knowledge and belief on information provided by third parties, and makes no representation or warranty as to the accuracy of such information. Efforts are underway to better integrate information from third parties. TI has taken and continues to take reasonable steps to provide representative and accurate information but may not have conducted destructive testing or chemical analysis on incoming materials and chemicals. TI and TI suppliers consider certain information to be proprietary, and thus CAS numbers and other limited information may not be available for release.

In no event shall TI's liability arising out of such information exceed the total purchase price of the TI part(s) at issue in this document sold by TI to Customer on an annual basis.

TAPE AND REEL INFORMATION

QUADRANT ASSIGNMENTS FOR PIN 1 ORIENTATION IN TAPE

*All dimensions are nominal

| Device | Package Type | Package Drawing | Pins | SPQ | Reel Diameter (mm) | Reel Width W1 (mm) | A0 (mm) | B0 (mm) | K0 (mm) | P1 (mm) | W (mm) | Pin1 Quadrant |
|-----------------|--------------|-----------------|------|------|--------------------|--------------------|---------|---------|---------|---------|--------|---------------|
| BQ27411DRZR-G1A | SON | DRZ | 12 | 3000 | 330.0 | 12.4 | 2.8 | 4.3 | 1.2 | 4.0 | 12.0 | Q2 |
| BQ27411DRZR-G1C | SON | DRZ | 12 | 3000 | 330.0 | 12.4 | 2.8 | 4.3 | 1.2 | 4.0 | 12.0 | Q2 |
| BQ27411DRZT-G1A | SON | DRZ | 12 | 250 | 180.0 | 12.4 | 2.8 | 4.3 | 1.2 | 4.0 | 12.0 | Q2 |
| BQ27411DRZT-G1C | SON | DRZ | 12 | 250 | 180.0 | 12.4 | 2.8 | 4.3 | 1.2 | 4.0 | 12.0 | Q2 |

TAPE AND REEL BOX DIMENSIONS



*All dimensions are nominal

| Device | Package Type | Package Drawing | Pins | SPQ | Length (mm) | Width (mm) | Height (mm) |
|-----------------|--------------|-----------------|------|------|-------------|------------|-------------|
| BQ27411DRZR-G1A | SON | DRZ | 12 | 3000 | 367.0 | 367.0 | 35.0 |
| BQ27411DRZR-G1C | SON | DRZ | 12 | 3000 | 367.0 | 367.0 | 35.0 |
| BQ27411DRZT-G1A | SON | DRZ | 12 | 250 | 210.0 | 185.0 | 35.0 |
| BQ27411DRZT-G1C | SON | DRZ | 12 | 250 | 210.0 | 185.0 | 35.0 |

DRZ (S-PDSO-N12)

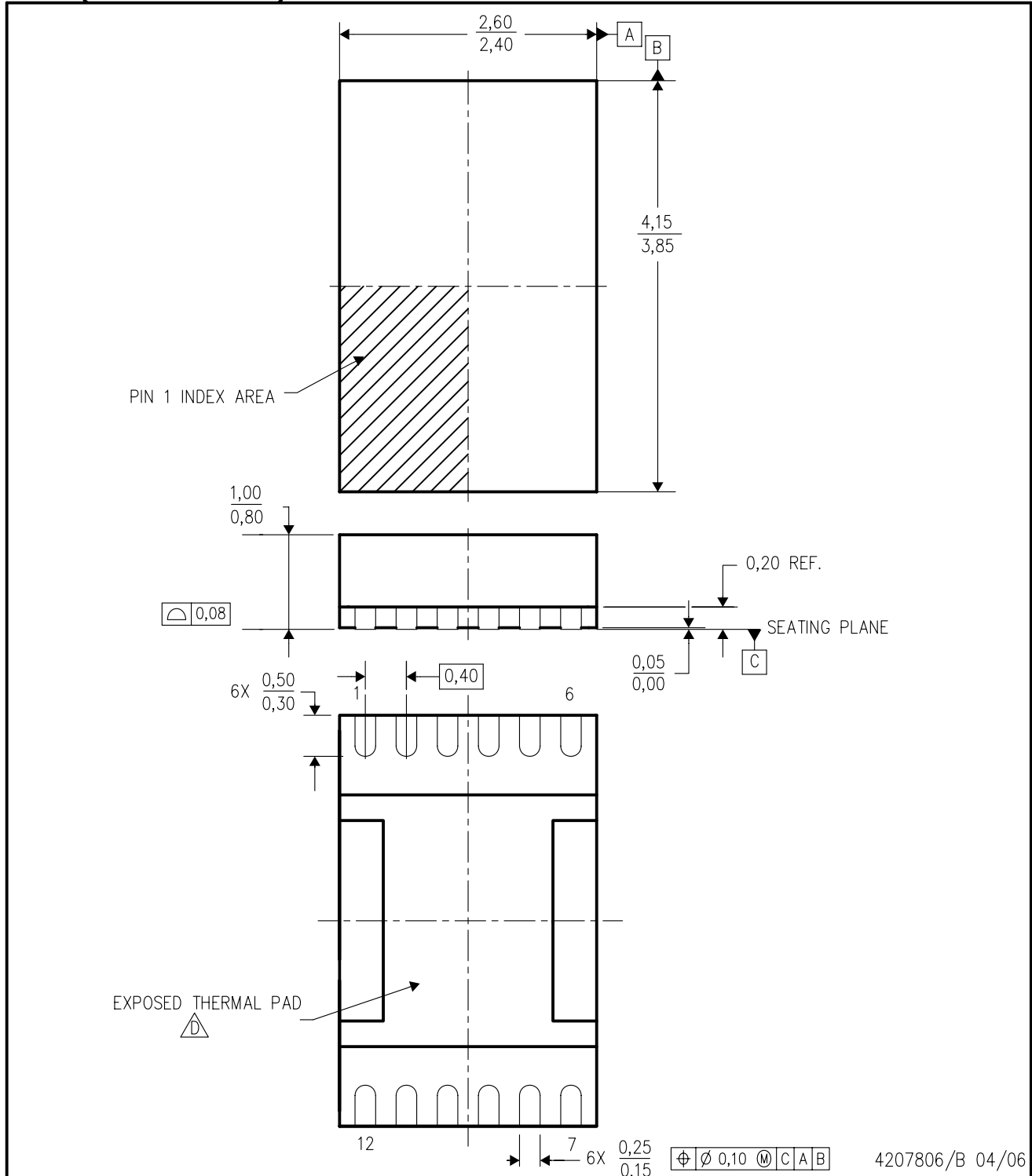
PLASTIC SMALL OUTLINE



- NOTES:
- A. All linear dimensions are in millimeters. Dimensioning and tolerancing per ASME Y14.5M-1994.
 - B. This drawing is subject to change without notice.
 - C. Small Outline No-Lead (SON) package configuration.
 -  The package thermal pad must be soldered to the board for thermal and mechanical performance. See the Product Data Sheet for details regarding the exposed thermal pad dimensions.
 - E. This package is lead-free.

THERMAL PAD MECHANICAL DATA

DRZ (R-PDSO-N12)

PLASTIC SMALL OUTLINE NO-LEAD

THERMAL INFORMATION

This package incorporates an exposed thermal pad that is designed to be attached directly to an external heatsink. The thermal pad must be soldered directly to the printed circuit board (PCB). After soldering, the PCB can be used as a heatsink. In addition, through the use of thermal vias, the thermal pad can be attached directly to the appropriate copper plane shown in the electrical schematic for the device, or alternatively, can be attached to a special heatsink structure designed into the PCB. This design optimizes the heat transfer from the integrated circuit (IC).

For information on the Quad Flatpack No-Lead (QFN) package and its advantages, refer to Application Report, QFN/SON PCB Attachment, Texas Instruments Literature No. SLUA271. This document is available at www.ti.com.

The exposed thermal pad dimensions for this package are shown in the following illustration.

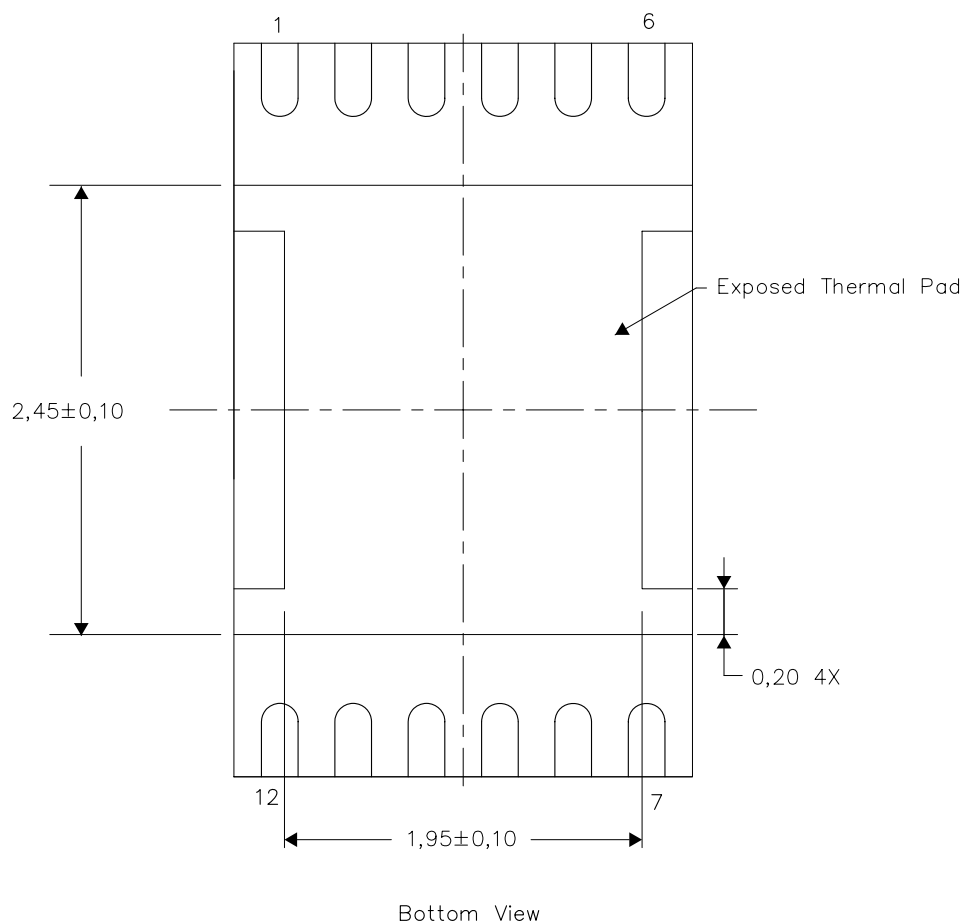

NOTE: All linear dimensions are in millimeters

Exposed Thermal Pad Dimensions

4208114/E 06/10

DRZ (S-PDSO-N12)

PLASTIC SMALL OUTLINE NO-LEAD

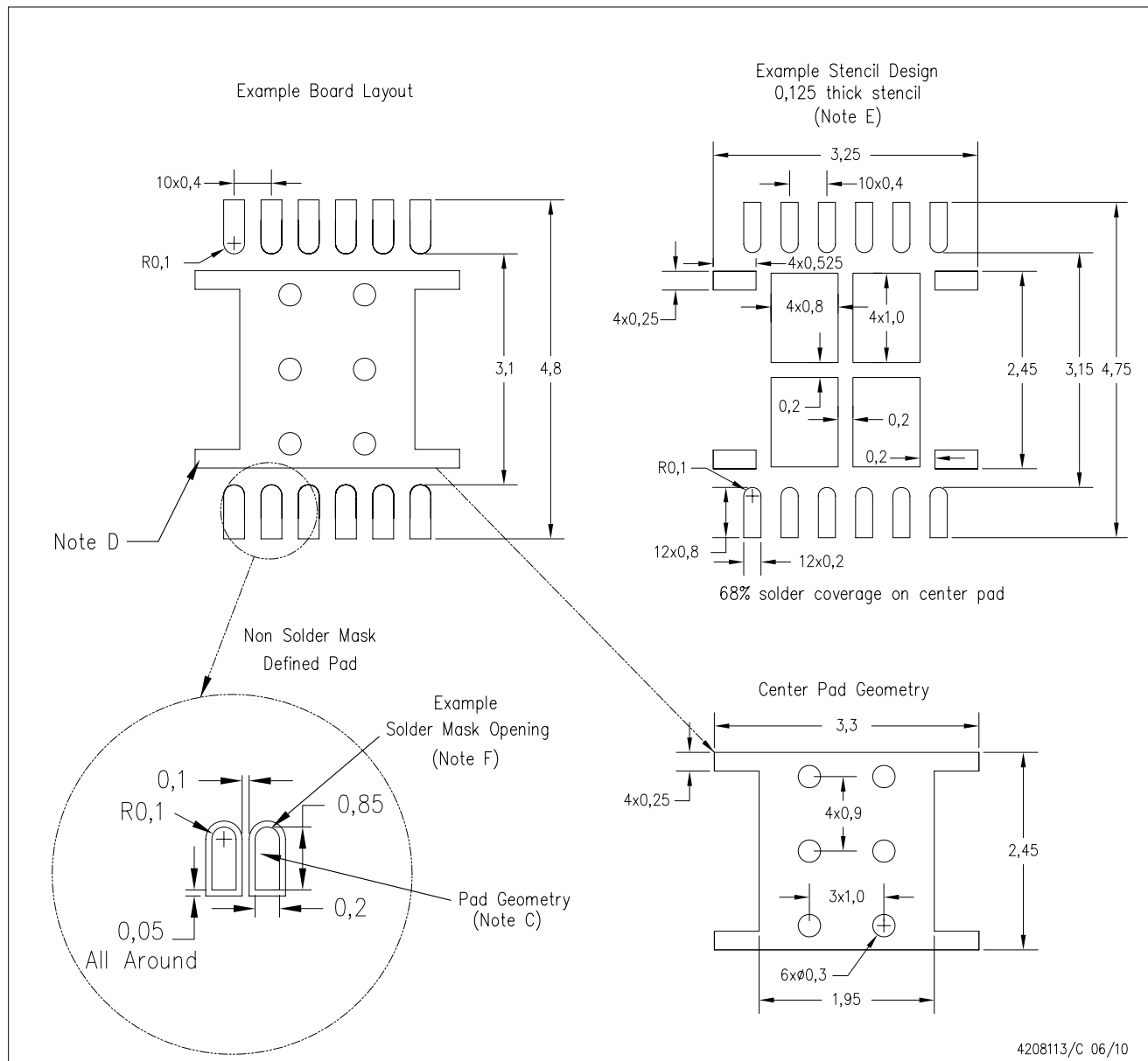

- NOTES:
- All linear dimensions are in millimeters.
 - This drawing is subject to change without notice.
 - Publication IPC-7351 is recommended for alternate designs.
 - This package is designed to be soldered to a thermal pad on the board. Refer to Application Note, Quad Flat-Pack Packages, Texas Instruments Literature No. SCBA017, SLUA271, and also the Product Data Sheets for specific thermal information, via requirements, and recommended board layout. These documents are available at www.ti.com <<http://www.ti.com>>.
 - Laser cutting apertures with trapezoidal walls and also rounding corners will offer better paste release. Customers should contact their board assembly site for stencil design recommendations. Refer to IPC 7525 for stencil design considerations.
 - Customers should contact their board fabrication site for minimum solder mask web tolerances between signal pads.

IMPORTANT NOTICE

Texas Instruments Incorporated and its subsidiaries (TI) reserve the right to make corrections, enhancements, improvements and other changes to its semiconductor products and services per JESD46, latest issue, and to discontinue any product or service per JESD48, latest issue. Buyers should obtain the latest relevant information before placing orders and should verify that such information is current and complete. All semiconductor products (also referred to herein as "components") are sold subject to TI's terms and conditions of sale supplied at the time of order acknowledgment.

TI warrants performance of its components to the specifications applicable at the time of sale, in accordance with the warranty in TI's terms and conditions of sale of semiconductor products. Testing and other quality control techniques are used to the extent TI deems necessary to support this warranty. Except where mandated by applicable law, testing of all parameters of each component is not necessarily performed.

TI assumes no liability for applications assistance or the design of Buyers' products. Buyers are responsible for their products and applications using TI components. To minimize the risks associated with Buyers' products and applications, Buyers should provide adequate design and operating safeguards.

TI does not warrant or represent that any license, either express or implied, is granted under any patent right, copyright, mask work right, or other intellectual property right relating to any combination, machine, or process in which TI components or services are used. Information published by TI regarding third-party products or services does not constitute a license to use such products or services or a warranty or endorsement thereof. Use of such information may require a license from a third party under the patents or other intellectual property of the third party, or a license from TI under the patents or other intellectual property of TI.

Reproduction of significant portions of TI information in TI data books or data sheets is permissible only if reproduction is without alteration and is accompanied by all associated warranties, conditions, limitations, and notices. TI is not responsible or liable for such altered documentation. Information of third parties may be subject to additional restrictions.

Resale of TI components or services with statements different from or beyond the parameters stated by TI for that component or service voids all express and any implied warranties for the associated TI component or service and is an unfair and deceptive business practice. TI is not responsible or liable for any such statements.

Buyer acknowledges and agrees that it is solely responsible for compliance with all legal, regulatory and safety-related requirements concerning its products, and any use of TI components in its applications, notwithstanding any applications-related information or support that may be provided by TI. Buyer represents and agrees that it has all the necessary expertise to create and implement safeguards which anticipate dangerous consequences of failures, monitor failures and their consequences, lessen the likelihood of failures that might cause harm and take appropriate remedial actions. Buyer will fully indemnify TI and its representatives against any damages arising out of the use of any TI components in safety-critical applications.

In some cases, TI components may be promoted specifically to facilitate safety-related applications. With such components, TI's goal is to help enable customers to design and create their own end-product solutions that meet applicable functional safety standards and requirements. Nonetheless, such components are subject to these terms.

No TI components are authorized for use in FDA Class III (or similar life-critical medical equipment) unless authorized officers of the parties have executed a special agreement specifically governing such use.

Only those TI components which TI has specifically designated as military grade or "enhanced plastic" are designed and intended for use in military/aerospace applications or environments. Buyer acknowledges and agrees that any military or aerospace use of TI components which have **not** been so designated is solely at the Buyer's risk, and that Buyer is solely responsible for compliance with all legal and regulatory requirements in connection with such use.

TI has specifically designated certain components as meeting ISO/TS16949 requirements, mainly for automotive use. In any case of use of non-designated products, TI will not be responsible for any failure to meet ISO/TS16949.

Products

| | |
|------------------------------|--|
| Audio | www.ti.com/audio |
| Amplifiers | amplifier.ti.com |
| Data Converters | dataconverter.ti.com |
| DLP® Products | www.dlp.com |
| DSP | dsp.ti.com |
| Clocks and Timers | www.ti.com/clocks |
| Interface | interface.ti.com |
| Logic | logic.ti.com |
| Power Mgmt | power.ti.com |
| Microcontrollers | microcontroller.ti.com |
| RFID | www.ti-rfid.com |
| OMAP Applications Processors | www.ti.com/omap |
| Wireless Connectivity | www.ti.com/wirelessconnectivity |

Applications

| | |
|-------------------------------|--|
| Automotive and Transportation | www.ti.com/automotive |
| Communications and Telecom | www.ti.com/communications |
| Computers and Peripherals | www.ti.com/computers |
| Consumer Electronics | www.ti.com/consumer-apps |
| Energy and Lighting | www.ti.com/energy |
| Industrial | www.ti.com/industrial |
| Medical | www.ti.com/medical |
| Security | www.ti.com/security |
| Space, Avionics and Defense | www.ti.com/space-avionics-defense |
| Video and Imaging | www.ti.com/video |

TI E2E Community

e2e.ti.com