

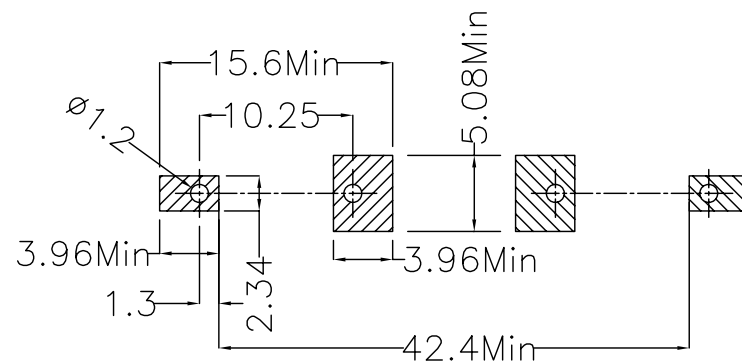

REV.	ECN NO.	REVISED	DATE

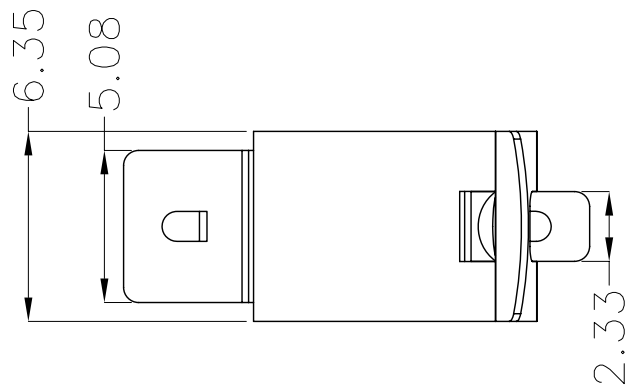

Scale: 2:1

PCB Layout Diagram
Top View

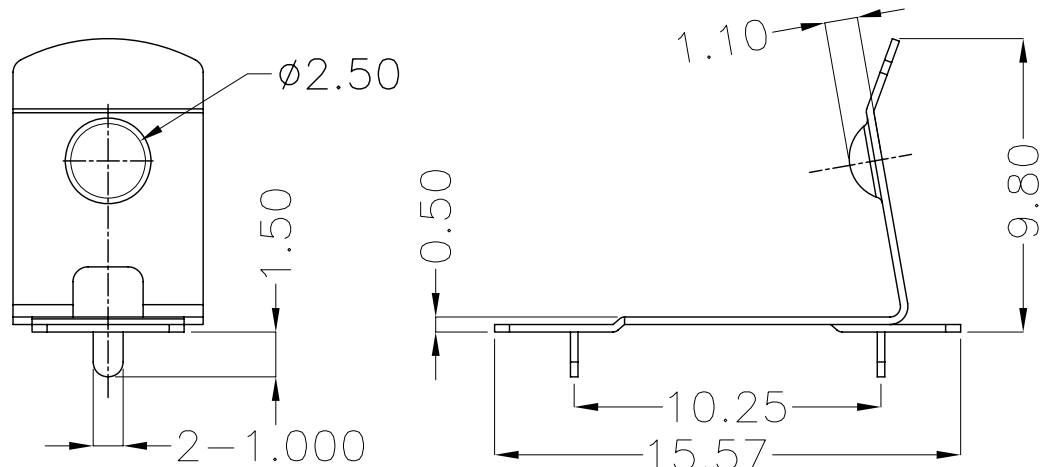

工程部
2017-07-19
ZW DANG

UNLESS OTHERWISE SPECIFIED TOLERANCES		MYOUNG 美阳 www.meiyangdz.com	
DECIMALS: X :±0.30 X.X :±0.25 X.XX :±0.20 X.XXX :±0.10	ANGLES: X :±1° X.X :±0.5°	DSND YangFeng	DATE 2017-07-19
WEIGHT: 0.27g		CHKD ZhouRuicai	DATE 2017-07-19
SHEET 1 OF 1		APVD XueShunyong	DATE 2017-07-19
TITLE:		SCALE: 4:1	SIZE: A4
PART NO.:		VIEW:	
DRAW NO.: MY-CP-0095		UNIT: mm	REV.: A/0
		OBJECT: MY	

1	TERMINAL	1	Mn STEEL, T=0.20mm	Ni-Plating
NO.	PART NAME	Q'TY	MATERIAL	PLATING & COLOR

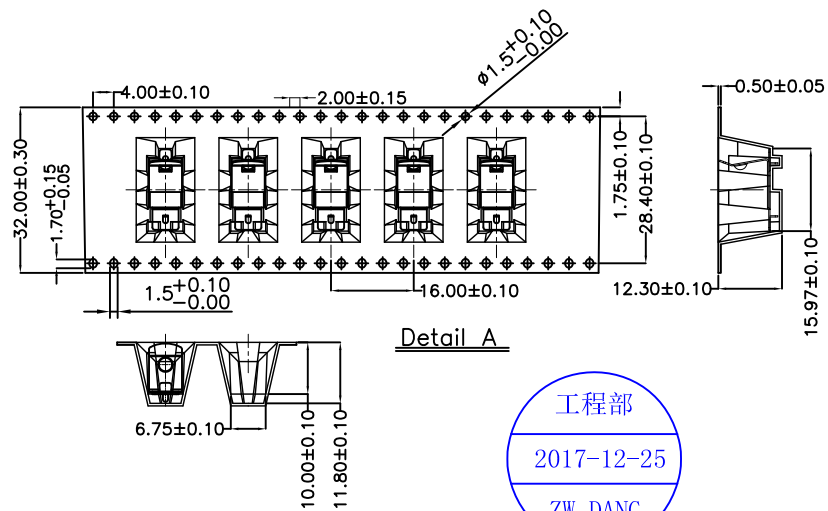
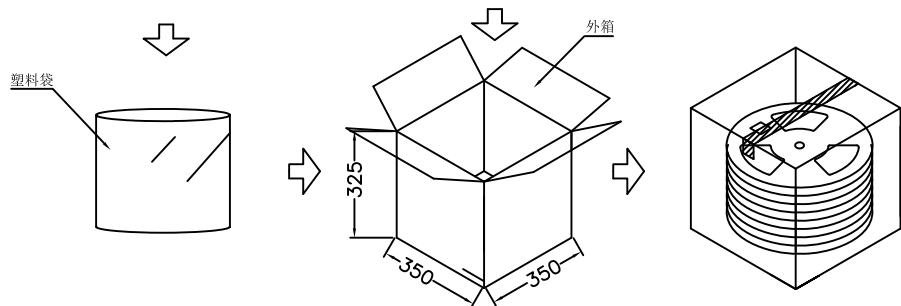
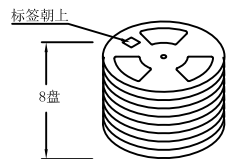
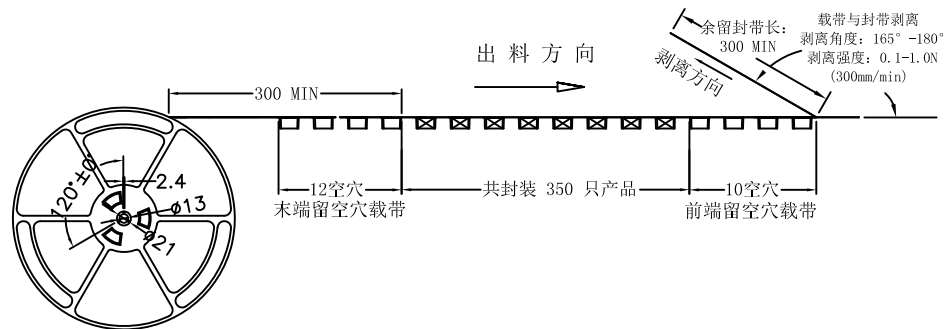
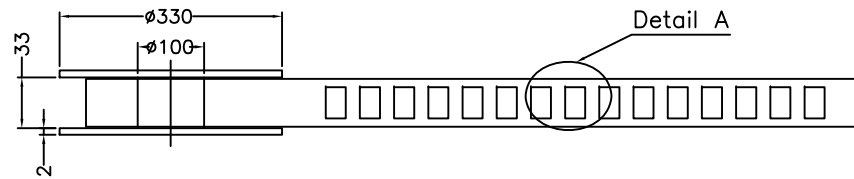
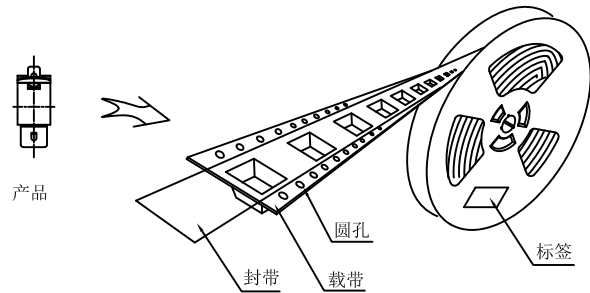

工程部
2017-12-25
ZW DANG

技术要求:

1. 圆孔十个孔距离累计允许公差为±0.2mm
2. 带长250mm内容许弯曲度1mm
3. 材料厚度以在载带边缘测量为准
4. 所有尺寸定义依循EIA-481-C系准则定义之
5. 材料: 黑色PS T=0.50mm
6. 所有卷轮为灰蓝挖空旋转塑胶卷轮
7. 整模成型长度: 5.952M,
8. 非指明公差范围为: ±0.1mm; 超过250mm不计算累计误差
9. 型腔外形凡未标明处倒角R为0.2-0.3; 拔模斜度未标注的为3° 以下

包装信息:

- 1、每卷盘装产品 350 只, 卷盘外侧贴相关标签;
- 2、每 8 卷盘放在一个塑料袋中;
- 3、每外箱装8盘, 产品总数: 2800 只;
- 4、外箱上下用胶纸封成“工”字;
- 5、净重: 0.8 KG, 毛重: 3.8 KG.

UNLESS OTHERWISE SPECIFIED TOLERANCES		MYOUNG 美阳 www.meiyangdz.com					
DECIMALS: X : ±*** X.X : ±*** X.XX : ±*** X.XXX : ±***	ANGLES: X : ±*** X.X : ±***	DSND	YangFeng	DATE	2017-12-01	TITLE:	
		CHKD	ZhouRuicai	DATE	2017-12-01	电池弹片TER-151 SMT 卷装	
		APVD	XueShun Yong	DATE	2017-12-01	PART NO.:	
WEIGHT:		SCALE:	3:1	SIZE:	A4	VIEW:	⊙ ⊚
SHEET 1 OF 1		UNIT:	mm	REV.:	A/0	OBJECT:	MY
				VIEW:	⊙ ⊚	MY-AAA-01-R	
				OBJECT:	MY	DRAW NO.:MY-BD-0013	