

ANT-8/9-SPNF1 Panel Mount 868/915 MHz LPWA Antenna

The ANT-8/9-SPNF1 antenna is an external panel mount dome-style multiband antenna designed for use in 868 MHz and 915 MHz frequency bands for low-power, wide-area (LPWA) applications such as LoRaWAN®, Sigfox® and WiFi HaLow™ as well as ISM and remote control applications.

The ANT-8/9-SPNF1 provides a ground plane independent dipole antenna solution which mounts permanently to metallic and non-metallic surfaces using the integrated N jack (female socket) connector while enabling an environmentally sealed enclosure and protection from tampering.



Features

- Performance at 862 MHz to 876 MHz
 - VSWR: ≤ 2.3
 - Peak Gain: 3.0 dBi
 - Efficiency: 88%
- Performance at 902 MHz to 930 MHz
 - VSWR: ≤ 2.9
 - Peak Gain: 3.1 dBi
 - Efficiency: 89%
- Ground plane independent dipole antenna
- N jack (female socket)
- External mount, includes all hardware for installation including 5/8"-24UNEF hex nut, washer and optional boot
- IP67 rating
- Impact resistant UV stabilized ABS radome material

Applications

- Low-power, wide-area (LPWA) applications
 - LoRaWAN®
 - Sigfox®
 - WiFi HaLow™ (802.11ah)
- Remote control, monitoring and sensing
- Internet of Things (IoT) devices
- ISM applications

Ordering Information

Part Number	Description
ANT-8/9-SPNF1	LPWA antenna with N jack (female socket) and mounting hardware

Available from Linx Technologies and select distributors and representatives.

Table 1. Electrical Specifications

ANT-8/9-SPNF1	868 MHz	915 MHz
Frequency Range	862 MHz to 876 MHz	902 MHz to 930 MHz
VSWR (max.)	2.3	2.9
Peak Gain (dBi)	3.0	3.1
Average Gain (dBi)	-0.6	-0.6
Efficiency (%)	88	89
Polarization	Linear	
Radiation	Omnidirectional	
Max Power	10 W	
Wavelength	1/2-wave	
Electrical Type	Dipole	
Impedance	50 Ω	

Electrical specifications and plots measured with a 300 mm x 300 mm (11.8 in x 11.8 in) ground plane.

Table 2. Mechanical Specifications

ANT-8/9-SPNF1	
Connection	N jack (female socket)
Weight	63.9 g (2.25 oz)
Dimensions	70.8 mm x Ø40.2 mm (2.79 in x Ø1.58 in)
IP Rating	IP67
Operating Temp. Range	-30 °C to +70 °C

Product Dimensions

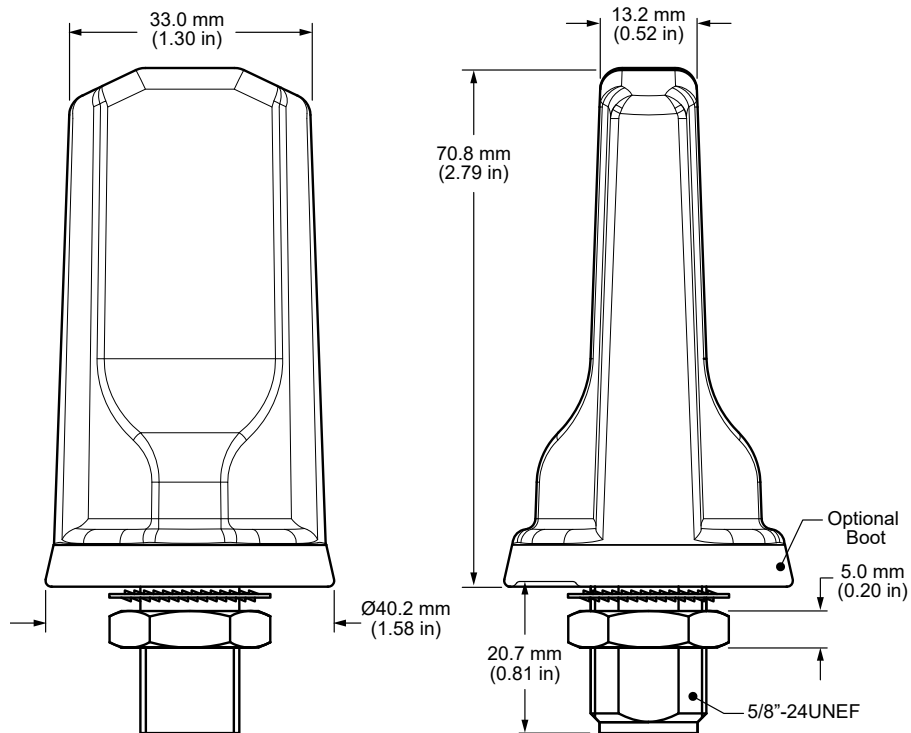

Figure 1. ANT-8/9-SPNF1 Dimensions

VSWR

Figure 2 provides the voltage standing wave ratio (VSWR) across the antenna bandwidth. VSWR describes the power reflected from the antenna back to the radio. A lower VSWR value indicates better antenna performance at a given frequency. Reflected power is also shown on the right-side vertical axis as a gauge of the percentage of transmitter power reflected back from the antenna.

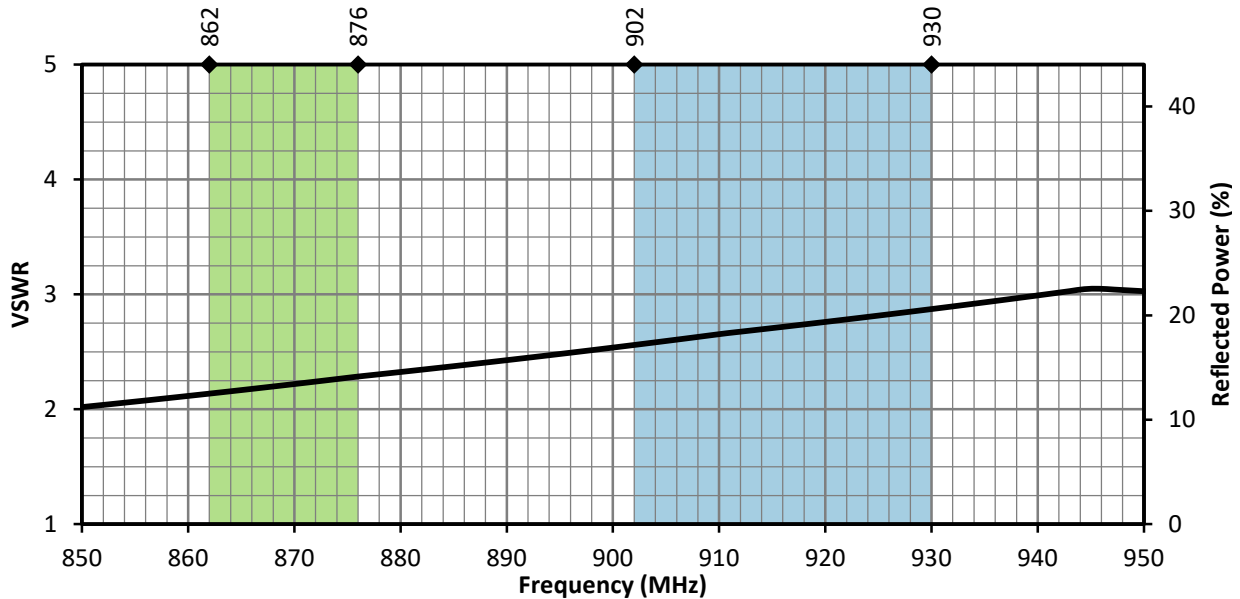

Figure 2. ANT-8/9-SPNF1 Antenna VSWR with Frequency Band Highlights

Return Loss

Return loss (Figure 3), represents the loss in power at the antenna due to reflected signals. Like VSWR, a lower return loss value indicates better antenna performance at a given frequency.

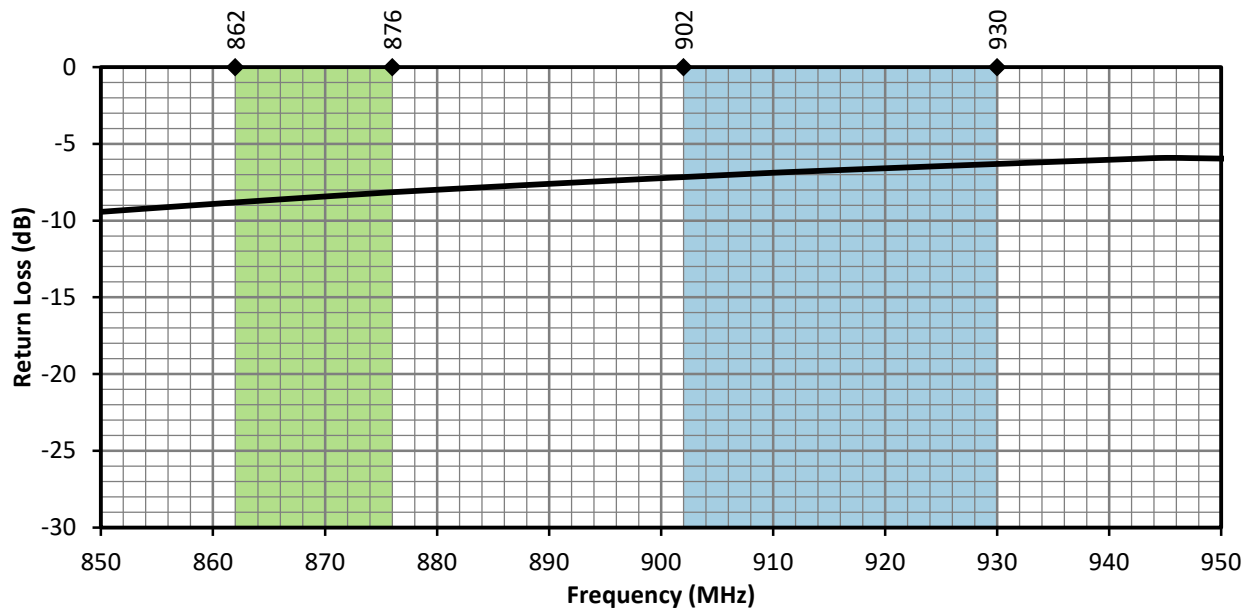

Figure 3. ANT-8/9-SPNF1 Antenna Return Loss with Frequency Band Highlights

Peak Gain

The peak gain across the antenna bandwidth is shown in Figure 4. Peak gain represents the maximum antenna input power concentration across 3-dimensional space, and therefore peak performance, at a given frequency, but does not consider any directionality in the gain pattern.

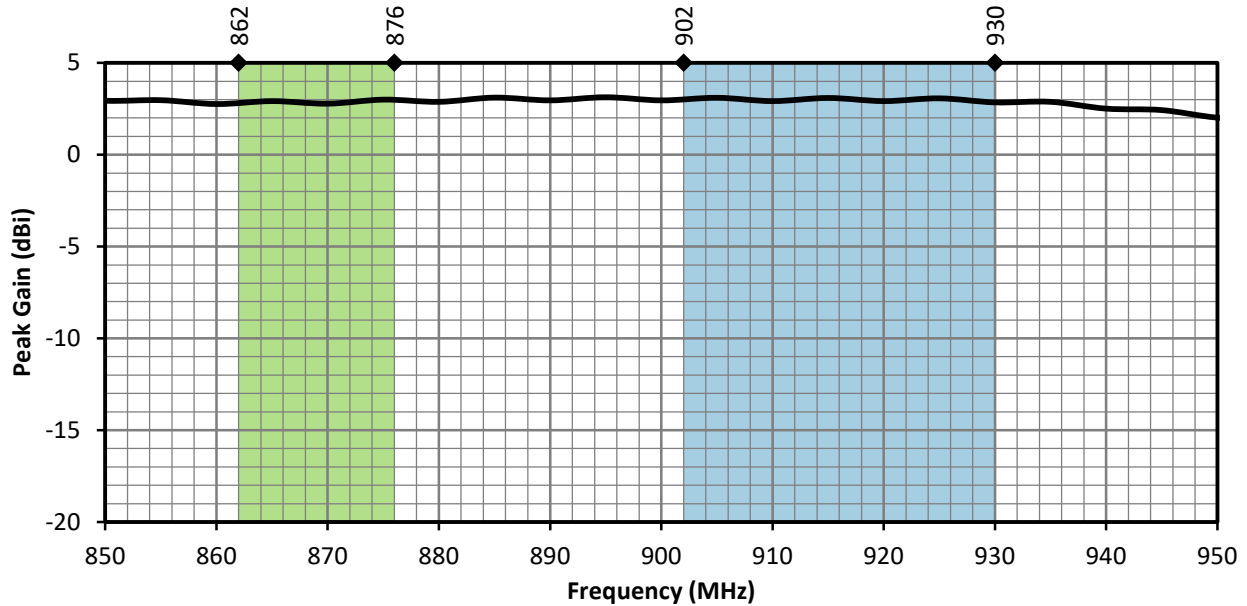

Figure 4. ANT-8/9-SPNF1 Antenna Peak Gain with Frequency Band Highlights

Average Gain

Average gain (Figure 5), is the average of all antenna gain in 3-dimensional space at each frequency, providing an indication of overall performance without expressing antenna directionality.

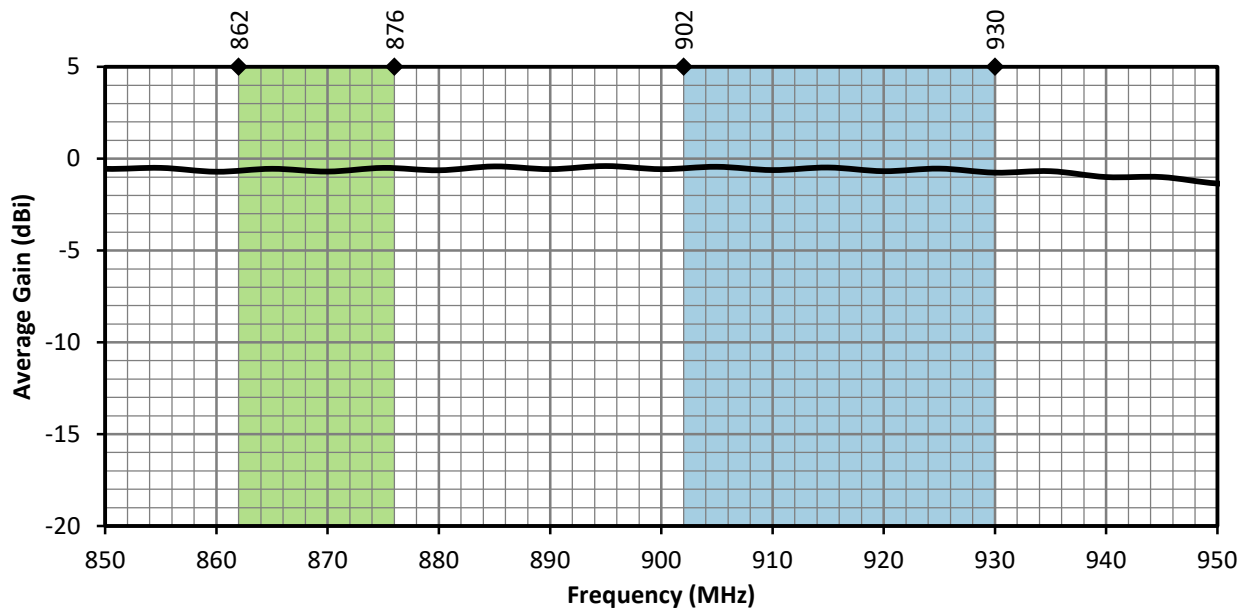

Figure 5. ANT-8/9-SPNF1 Antenna Average Gain with Frequency Band Highlights

Radiation Efficiency

Radiation efficiency (Figure 6), shows the ratio of power delivered to the antenna relative to the power radiated at the antenna, expressed as a percentage, where a higher percentage indicates better performance at a given frequency.

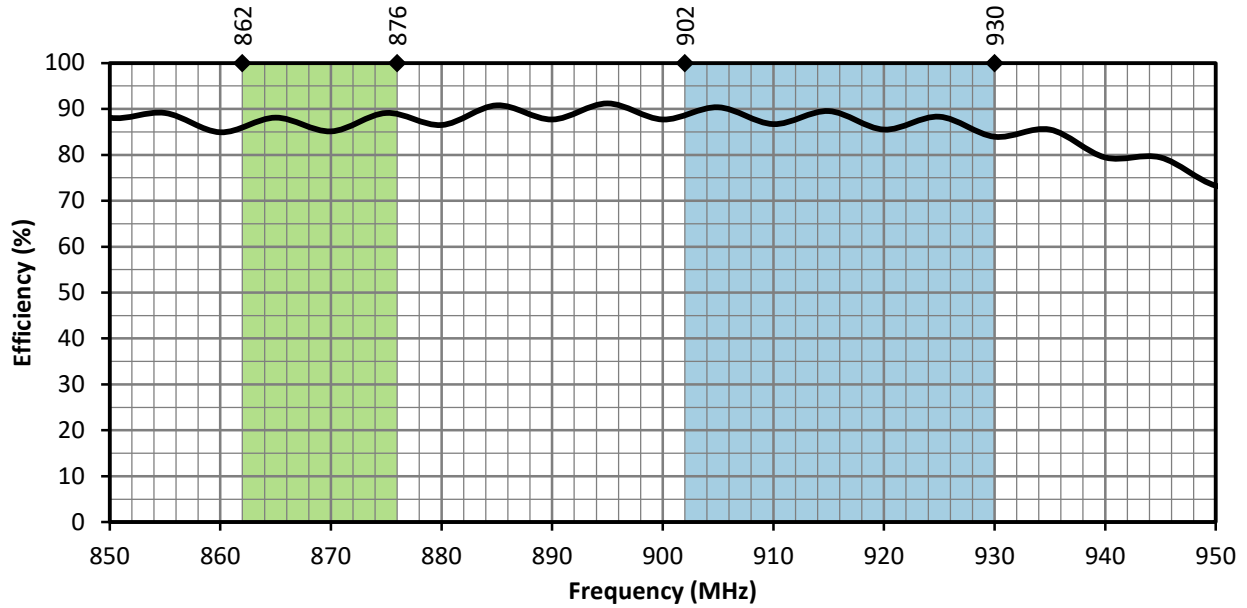

Figure 6. ANT-8/9-SPNF1 Antenna Radiation Efficiency with Frequency Band Highlights

Radiation Patterns

Radiation patterns provide information about the directionality and 3-dimensional gain performance of the antenna by plotting gain at specific frequencies in three orthogonal planes. Antenna radiation patterns (Figure 7), are shown using polar plots covering 360 degrees. The antenna graphic above the plots provides reference to the plane of the column of plots below it. Note: when viewed with typical PDF viewing software, zooming into radiation patterns is possible to reveal fine detail.



862 MHz to 876 MHz (868 MHz)

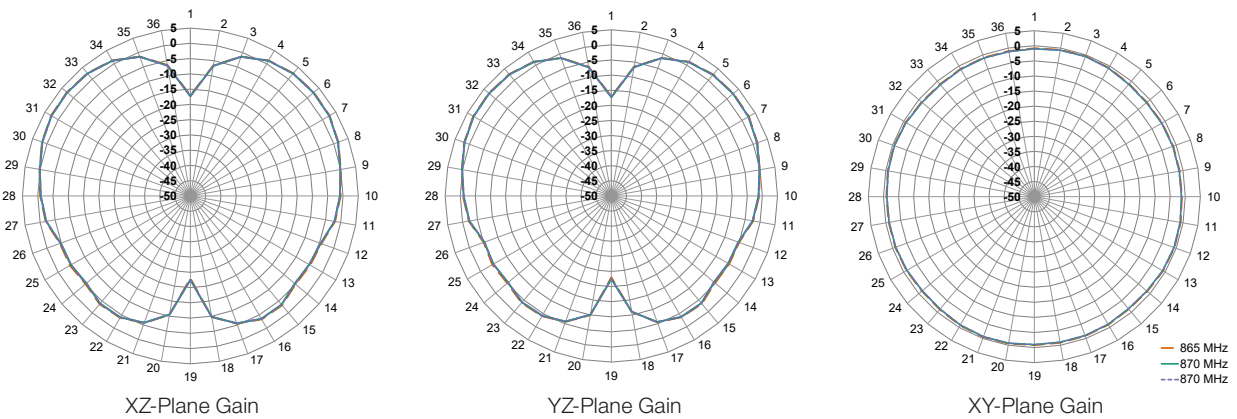

902 MHz to 930 MHz (915 MHz)

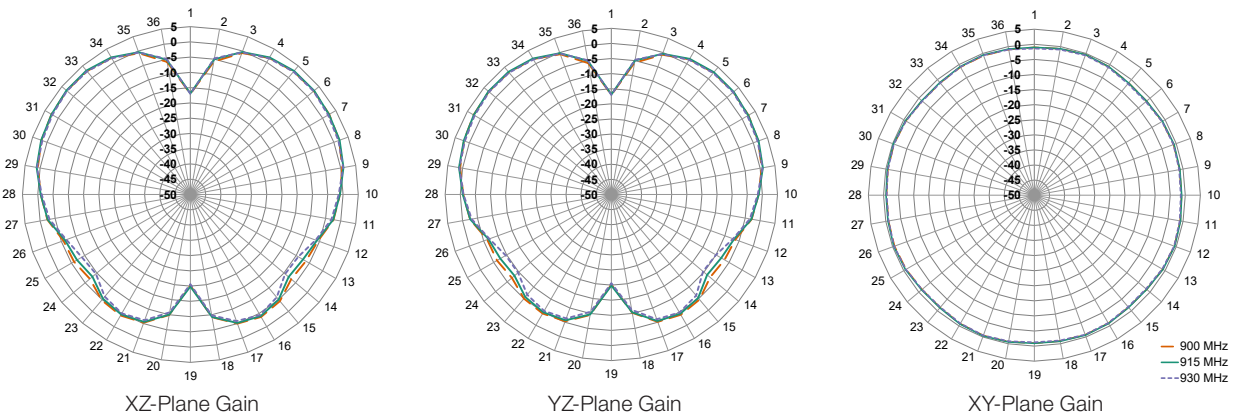

Figure 7. Radiation Patterns for ANT-8/9-SPNF1 Antenna

LPWA: LoRaWAN® and Sigfox®

LoRaWAN and Sigfox LPWA technologies operate within several of the frequencies supported by the 8/9-SPNF1 antenna. Notably, LoRaWAN operates at the frequency bands shown in Table 3. Sigfox operates at different frequencies determined by country (Table 4).

Table 3. LoRaWAN® Channel plan

Frequency Band	LoRaWAN Channel Plan
779 MHz to 787 MHz	CN779-787
865 MHz to 867 MHz	IN765-867
868 MHz to 873 MHz	EU863-870
902 MHz to 928 MHz	US902-928, AS923
915 MHz to 928 MHz	AU915-928
917 MHz to 923.5 MHz	KR920-923

Table 4. Sigfox® Frequencies by Country/Region

Center Frequency	Select Countries/Regions
868 MHz	Europe
902 MHz	USA, Mexico, Brazil
920 MHz	Australia
923 MHz	Japan

Antenna Mounting

The ANT-8/9-SPNF1 antenna is an externally mounted multiband antenna that can be permanently installed onto metallic and non-metallic surfaces up to 3.16 mm (0.12 in) thick when used with the provided boot, and up to 4.0 mm (0.16 in) without the boot. Use of the boot is optional, and is intended to reduce the potential for marring of the mounting surface.

The antenna terminates in a 5/8"-24UNEF threaded N connector shaft which doubles as the mounting base and is provided with a washer and hex nut. The mounting hole dimensions are shown in Figure 8.

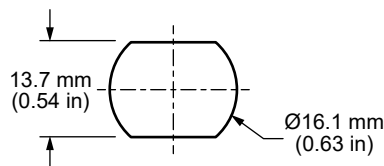

Figure 8. ANT-8/9-SPNF1 Mounting Hole Dimensions

Packaging Information

The ANT-8/9-SPNF1 antenna is individually placed in a polyethylene bag. 10 pcs. are sealed in larger polyethylene bags. Larger quantities are shipped in cartons of 60 pcs. Carton size = 320 mm x 250 mm x 230 mm (12.60 in x 9.84 in x 9.10 in). Distribution channels may offer alternative packaging options.

Website: <http://linxtechnologies.com>
Linx Offices: 159 Ort Lane, Merlin, OR, US 97532
Phone: +1 (541) 471-6256
E-MAIL: info@linxtechnologies.com

Linx Technologies reserves the right to make changes to the product(s) or information contained herein without notice. No liability is assumed as a result of their use or application. No rights under any patent accompany the sale of any such product(s) or information.

Wireless Made Simple is a registered trademark of Linx Acquisitions LLC. LoRaWAN is a registered trademark of Semtech Corporation. Sigfox is a registered trademark of SIGFOX. Other product and brand names may be trademarks or registered trademarks of their respective owners.

Copyright © 2021 Linx Technologies

All Rights Reserved

Doc# DS21033-143ANT

