



Product Features

- GaN on SiC Chip on Board
- Surface Mount Hybrid Type
- 2-Stage Doherty Amplifier
- High Efficiency
- No Matching circuit needed

Applications

- RF Sub-Systems
- Base Station
- RRH
- 4G/ LTE system
- Small cell

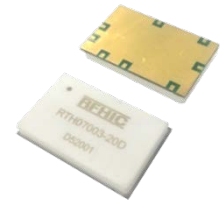

Package Type : SP-1E

Description

Accommodating the future of 4G/LTE small cells, RFHIC introduces RTH07003-20D amplifier fabricated using an advanced high power density Gallium Nitride (GaN) semiconductor process.

Electrical Specifications @ $V_{ds1}=5V$, $V_{ds2}=30V$, $T_a=25^\circ C$

PARAMETER	UNIT	MIN	TYP	MAX	CONDITION
Frequency Range	MHz	773	778	783	ZS = ZL = 50 ohm
Power Gain		27	30	-	
Gain Flatness	dB	-1.5	-	+1.5	-
Input Return Loss		-	-14	-9	
Pout @ Average	dBm	-	34.7	-	2.951W
Pout @ Saturation	dBm	42.2	42.7	-	Pulse Width=20us, Duty cycle 10%
ACLR @ BW 10MHz LTE (PAPR 7.5dB)	dBc	-	-29	-25	Non DPD
		-	-53	-	With DPD
Doherty Efficiency	%	-	43	-	$T_c=25^\circ C$
Total Efficiency		35	38	-	
Drive Amp. Idq	mA	-	180	-	Inverted Doherty
Carrier Amp. Idq		-	120	-	
Peaking Amp. Idq		-	0	-	
Supply Voltage	V	-4.9	-4.5	-3.0	Vgc
		-4.9	-2.8	-2.0	Vgp
		-	5.0	-	Vds1
		-	30	-	Vds2

Caution

The drain voltage must be supplied to the device after the gate voltage is supplied

Turn on → Turn on the Gate voltage supply and last turn on the Drain voltage supplies

Turn off → Turn off the Drain voltage and last turn off the Gate voltage

Note

1. ACLR Measured Pout=34.7dBm @ $f_c \pm 10MHz / 9.015MHz$
LTE 10MHz 1FA PAPR=7.5dB @ 0.01% probability on CCDF

Mechanical Specifications

PARAMETER	UNIT	TYPICAL	RATING
Mass	g	6.0	± 1.0
Dimension	mm	32 x 20 x 4.2	± 0.15

Absolute Maximum Ratings

PARAMETER	UNIT	RATING	SYMBOL	CONDITION
Gate-Source Voltage	V	-10 ~ 0	V _{gc} V _{gp}	T _c =25°C
Drain-Source Voltage 1	V	7	V _{ds1}	T _c =25°C
Drain-Source Voltage 2	V	50	V _{ds2}	T _c =25°C
Gate Current	mA	4 4	Carrier Peaking	T _c =25°C
Power Dissipation	W	6.1	P _d	T _c =85°C
Operating Junction Temperature	°C	225	T _J	-
Operating Case Temperature	°C	-30 ~ 85	T _C	-
Storage Temperature	°C	-40 ~ 100	T _{STG}	-
Soldering Temperature ^{*1}	°C	260	T _s	30s Max.
RF Input Level (Pulse)	dBm	30	Pin	T _c =25°C

*1 Reflow cycle limit : 1time

Operating Voltages & Input level

PARAMETER	UNIT	MIN	TYP	MAX	SYMBOL
Drain Voltage 1	V	4.75	5	5.25	V _{ds1}
Drain Voltage 2	V	29.5	30	30.5	V _{ds2}
Gate Voltage (on-stage)	V	-4.9	V _{gc} ^{*2}	-3.0	V _{gc}
Gate Voltage (on-stage)	V	-4.9	V _{gp} ^{*3}	-2.0	V _{gp}
Gate Voltage (off-stage)	V	-	-8	-	V _{gc}
Gate Voltage (off-stage)	V	-	-8	-	V _{gp}
RF Input Level (Pulse)	dBm	-	-	25	Pin

*2 V_{gc}(Pin#13) set: Lower V_{gc} of Δ-1.75V at Peaking I_{dq} 100mA±5%

*3 V_{gp}(Pin#5) set: Carrier I_{dq} 120mA±5%

ESD Level

PARAMETER	STANDARD	RESULT
HBM	JESD22-A114E	Class 1B/ passed Voltage 700V
MM	JESD22-A115C	Class A/ passed Voltage 150V

Block Diagram

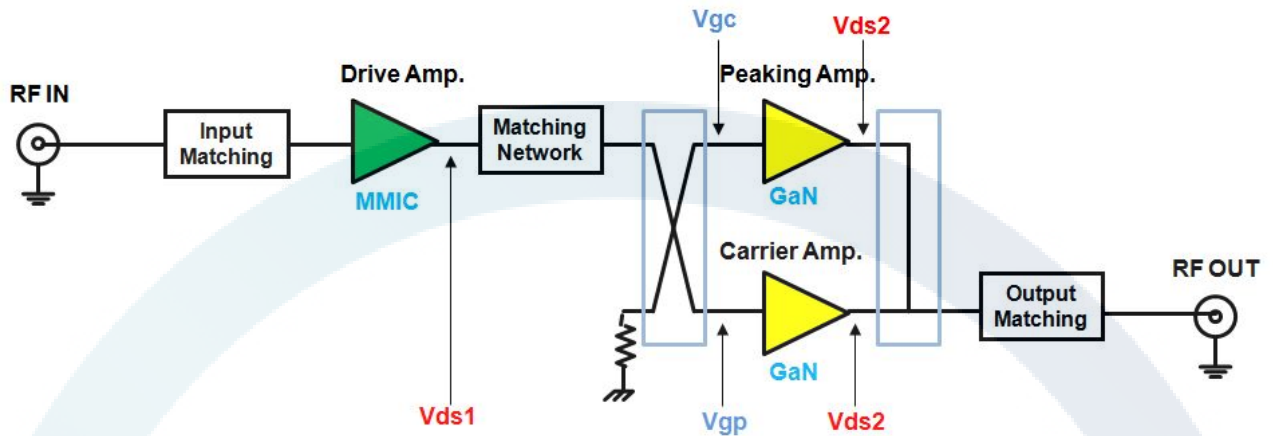

Application Circuit

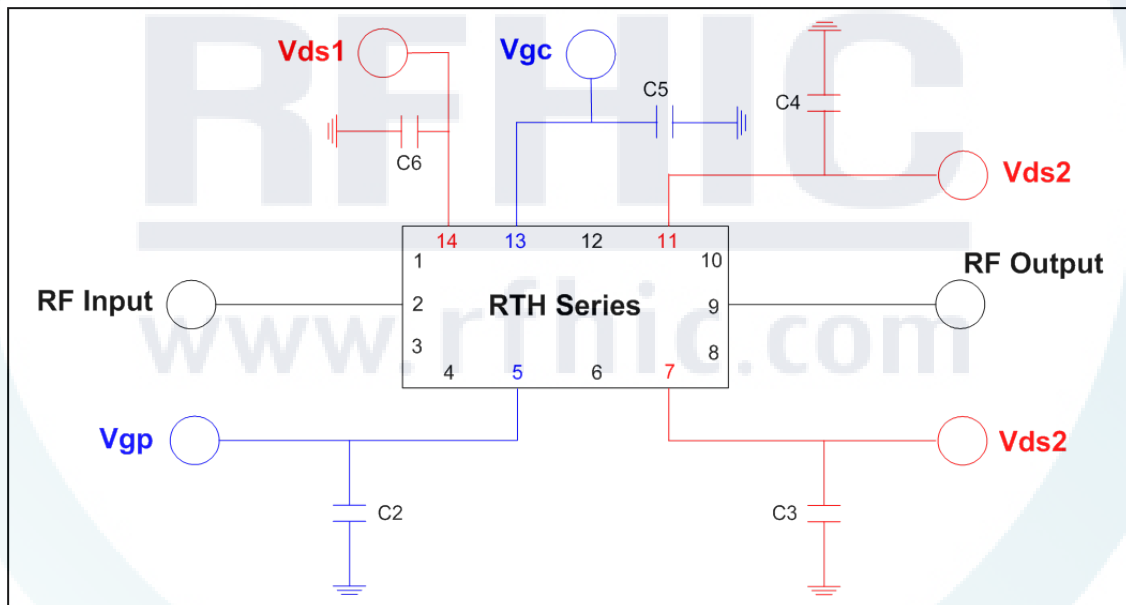

Bill of Material (Evaluation board)

LOCATION	Part Number	Value	Manufacturer
C3, C4, C6	1812B225K101CT	2.2uF / 100V	WALSIN
C2, C5	GRM188R71C105KA12D	1uF / 16V	MURATA
PCB	RO4350B	2Layer, 20mil, 1oz	ROGERS

Performance Charts

* **Bias condition** @ Drive $I_{dq}=180\text{mA}$, Carrier $I_{dq}=120\text{mA}$, Peaking $I_{dq}=0\text{mA}$, $T_a=25^\circ\text{C}$

Power Gain vs. Output Power

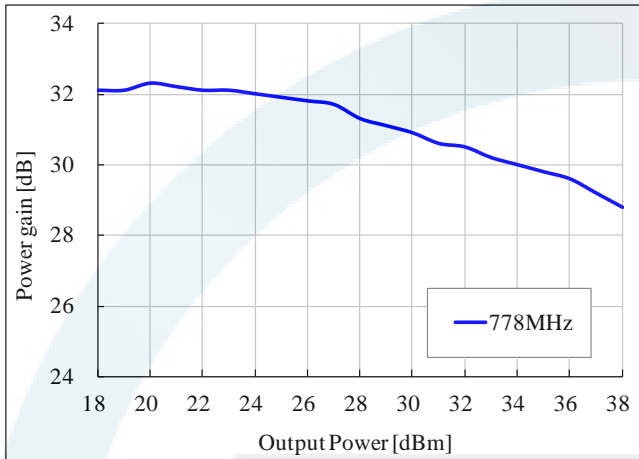

Drain Efficiency vs. Output Power

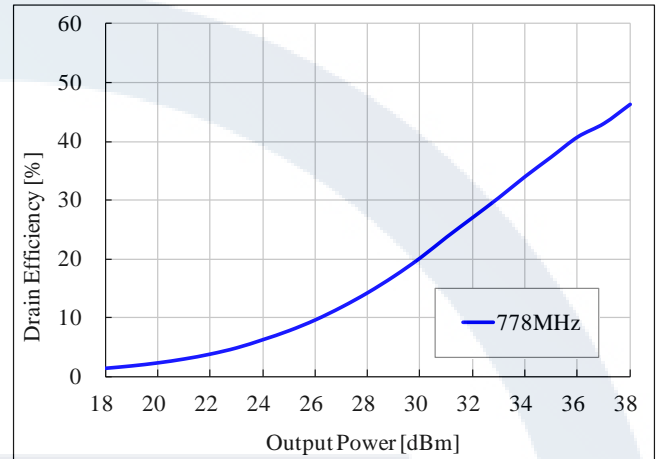

ACLR vs. Output Power

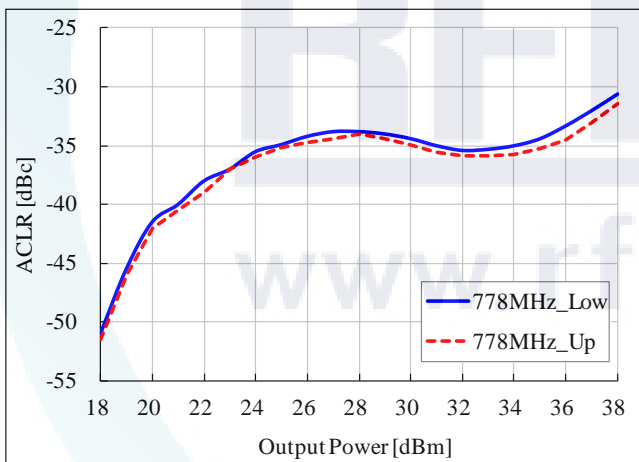

Current vs. Output Power

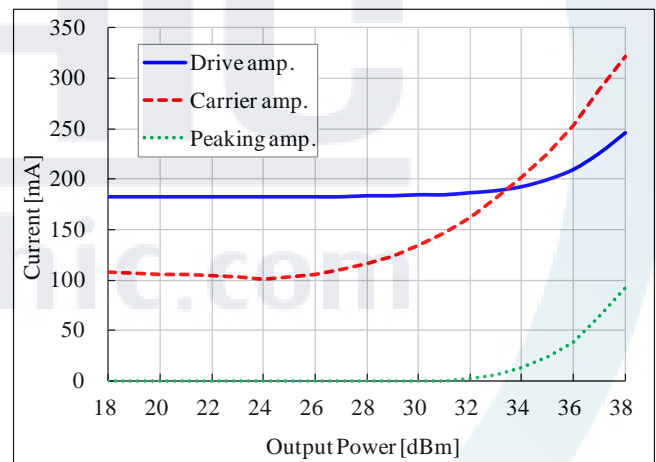

Package Dimensions (Type: SP-1E)

* Unit: mm[inch] | Tolerance: ± 0.15 [.006]

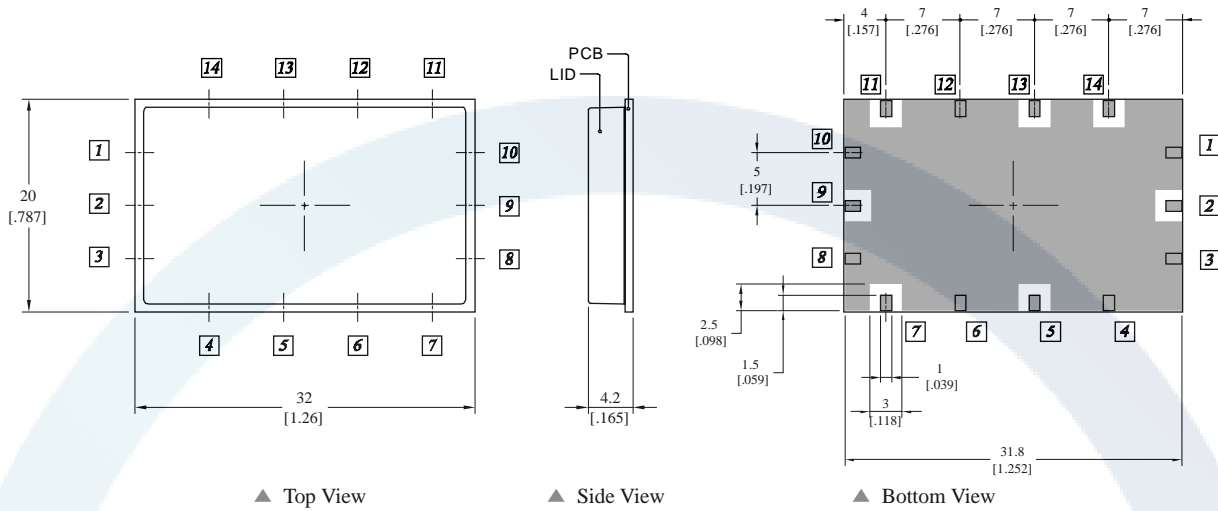

Pin Description (RTH07003-20D)							
Pin No	Function	Pin No	Function	Pin No	Function	Pin No	Function
1	GND	4	GND	8	GND	11	Vds2
2	RF In	5	Vgp	9	RF Out	12	GND
3	GND	6	GND	10	GND	13	Vgc
		7	Vds2			14	Vds1

Recommended Mounting Configuration

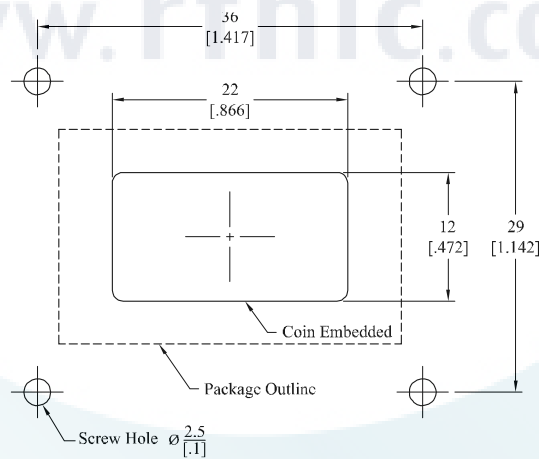

* Mounting Configuration Notes

- For the proper performance of the device, Ground / Thermal via holes must be designed to remove heat.
- To properly use heatsink, ensure the ground/thermal via hole region to contact the heatsink. We recommend the mounting screws be added near the heatsink to mount the board
- In designing the necessary RF trace, width will depend upon the PCB material and construction.
- Use 1 oz. Copper minimum thickness for the heatsink.
- Do not put solder mask on the backside of the PCB in the region where the board contacts the heatsink
- We recommend adding as much copper as possible to inner and outer layers near the part to ensure optimal thermal performance.
- We recommend that the PCB with the RF device in a hybrid package(RTH Series) is not washed to remove the flux.

Ordering Information

Part Number	Package Design
RTH07003-20D	-R (Reel)
	-B (Bulk)
	-EVB (Evaluation Board)

Revision History

Part Number	Release Date	Version	Modification	Data Sheet Status
RTH07003-20D	2016.04.20	3.0	Electrical Specification (1p) Performance Charts (3p)	-
RTH07003-20D	2015.06.22	1.3	Electrical Specification	-
RTH07003-20D	2015.06.04	1.2	Electrical Specification Absolute Maximum Ratings	-



RFHIC Corporation reserves the right to make changes to any products herein or to discontinue any product at any time without notice. While product specifications have been thoroughly examined for reliability, RFHIC Corporation strongly recommends buyers to verify that the information they are using is accurate before ordering. RFHIC Corporation does not assume any liability for the suitability of its products for any particular purpose, and disclaims any and all liability, including without limitation consequential or incidental damages. RFHIC products are not intended for use in life support equipment or application where malfunction of the product can be expected to result in personal injury or death. Buyer uses or sells such products for any such unintended or unauthorized application, buyer shall indemnify, protect and hold RFHIC Corporation and its directors, officers, stockholders, employees, representatives and distributors harmless against any and all claims arising out of such unauthorized use.

Sales, inquiries and support should be directed to the local authorized geographic distributor for RFHIC Corporation. For customers in the US, please contact the US Sales Team at 919-655-1121-. For all other inquiries, please contact the International Sales Team at 82-31-8069-3000.