

SPECIFICATION

Part No. : **MA240.LBI.001**

Product Name : MA240 Genesis 2 x LTE/GNSS 3in1
Adhesive Mount Combination Antenna
1* GNSS – GPS-GLONASS-GALILEO
2* 4G LTE 698 to 896/1710 to 2700MHz
Supports 3G Fall-back

Features : IP65 Antenna
1* GPS-GLONASS: 2 meter RG-174 SMA(M)
2 * LTE: 2 meter Low loss NFC-200 SMA(M)ST
Dimensions: 205.8mm x 58mm x 12.4mm
RoHS Compliant



1. Introduction

The MA.240 4G Genesis antenna is an omni-directional, fully IP65 waterproof external M2M antenna for use in telematics, transportation and remote monitoring applications worldwide. It is designed to be mounted directly on glass or plastic in the interior of vehicles.

Typical applications

- HD Video over LTE
- First Responder and Emergency Services
- Automotive Vehicle Tracking and Telematics

This unique antenna delivers powerful dual antenna technology for worldwide 4G LTE bands at 700MHz / 800MHz / 1700MHz / 1800MHz / 2600MHz, plus GPS/GLONASS/GALILEO for next generation location accuracy.

4G wireless applications demand high speed data uplink and downlink. High efficiency and high gain antennas are necessary to achieve the required signal to noise ratio and throughput required to solve these challenges. Taoglas also takes care to have high isolation between the two LTE antennas to prevent self-interference. Low loss cables are used to keep efficiency high over long cable lengths. In contrast, smaller LTE antennas with poorer quality thinner cables will have much reduced efficiency and isolation, which would lead to a large drop in system throughput or drops, and may indeed not make a system connection at all.

The GPS/GLONASS/GALILEO antenna has been carefully designed to work equally well on both GPS and GLONASS bands, leading to higher location accuracy and stability of tracking in urban environments.

Finally, if your device requires USA LTE certification with an external antenna then the MA240 is the ideal solution to pass approvals.

Cable length and connector types are customizable. [Contact](#) your regional Taoglas sales office for support.

2. Specification

GPS-GLONASS-GALILEO	
Center Frequency	GPS/GALILEO: 1575.42±3 MHz GLONASS: 1602±0.5 MHz
Passive Antenna Gain	GPS/GALILEO: 1.67dBi GLONASS: 0.37dBi
VSWR	1.5:1 Max
Impedance	50Ω
Cable	2 meters RG174 standard, fully customizable
Connector	SMA(M), standard, fully customizable
LNA Electrical Properties	
Center Frequency	GPS/GALILEO: 1575.42±3 MHz GLONASS: 1602±0.5 MHz
Impedance	50 Ohm
VSWR	< 1.5:1
Return Loss	10 dB Min.
Gain	3.3V 30dB
DC Power Input	3.3V
Noise Figure @3.3V	1.7dB

4G/3G MIMO 1											
Frequency (MHz)	698 ~803	703 ~803	824 ~894	880 ~960	1710 ~1880	1850 ~1990	1920 ~2170	2305 ~2360	2490 ~2690	3410 ~3490	3400 ~3600
Efficiency (%)											
In free space	30cm	58.24		56.13	53.67	76.47	68.59	62.96		74.88	56.10
	1M	64.65		57.39	48.73	62.52	53.06	48.63		50.84	30.29
	2M	51.90		46.53	46.74	62.79	55.87	51.48		59.06	42.12
	3M	47.88		45.93	43.42	55.53	49.19	45.01		50.66	35.40
	5M	41.47		38.78	36.45	43.44	38.00	34.87		38.49	25.38
On the 2mm ABS base	30cm	63.50		33.06	39.97	69.58	59.05	54.39		61.78	39.33
	1M	73.97		51.78	44.03	63.30	48.55	46.18		52.15	27.82
	2M	56.60		29.34	34.82	57.11	48.11	44.46		48.71	29.50
	3M	53.49		27.18	32.32	50.22	44.24	38.88		41.62	30.25
	5M	45.23		22.87	27.09	39.51	32.73	30.11		31.75	17.78
On the glass base	30cm	66.98		26.43	29.96	63.52	59.22	60.07		71.14	38.27
	1M	52.66		47.32	35.07	53.47	52.02	50.64		64.75	29.52
	2M	59.70		23.27	26.09	52.25	48.25	49.10		56.09	28.70
	3M	57.47		21.58	23.80	46.05	42.08	42.68		47.91	26.90
	5M	47.72		18.28	20.30	36.15	32.78	33.26		36.55	17.29
Average Gain(dBi)											
In free space	30cm	-2.37		-2.71	-2.88	-1.17	-1.67	-2.04		-1.27	-2.53
	1M	-1.92		-2.46	-3.24	-2.05	-2.83	-3.19		-2.96	-5.19
	2M	-2.87		-3.52	-3.48	-2.03	-2.55	-2.91		-2.30	-3.78
	3M	-3.22		-3.56	-3.81	-2.56	-3.11	-3.50		-2.97	-4.53
	5M	-3.85		-4.31	-4.56	-3.63	-4.23	-4.61		-4.16	-5.98
On the 2mm ABS base	30cm	-2.01		-4.90	-4.04	-1.59	-2.32	-2.65		-2.10	-4.05
	1M	-1.32		-2.92	-3.62	-2.03	-3.21	-3.41		-2.85	-5.56
	2M	-2.51		-5.42	-4.64	-2.44	-3.21	-3.53		-3.13	-5.30
	3M	-2.75		-5.74	-4.97	-3.00	-3.58	-4.11		-3.82	-5.26
	5M	-3.49		-6.50	-5.73	-4.04	-4.89	-5.22		-4.99	-7.50
On the glass base	30cm	-1.88		-5.81	-5.27	-2.02	-2.29	-2.22		-1.48	-4.17
	1M	-2.95		-3.28	-4.57	-2.81	-2.87	-2.98		-1.90	-5.30
	2M	-2.38		-6.36	-5.87	-2.88	-3.18	-3.09		-2.52	-5.42
	3M	-2.51		-6.69	-6.29	-3.43	-3.78	-3.70		-3.20	-5.73
	5M	-3.36		-7.41	-6.96	-4.48	-4.86	-4.79		-4.38	-7.62

Peak Gain(dBi)												
In free space	30cm	1.57		1.71	1.59	3.04	3.41	3.21		4.82	4.81	
	1M	2.41		2.17	1.33	2.00	2.14	1.94		2.16	1.29	
	2M	1.07		0.83	0.99	2.19	2.52	2.33		3.78	3.56	
	3M	0.74		0.85	0.66	1.65	1.96	1.75		3.14	2.81	
	5M	0.10		0.11	-0.09	0.59	0.84	0.64		1.92	1.36	
On the 2mm ABS base	30cm	3.44		-0.13	0.28	2.23	2.06	2.09		2.56	2.44	
	1M	2.26		0.96	0.89	1.98	2.03	2.04		2.58	0.93	
	2M	2.94		-0.50	-0.32	1.38	1.17	1.22		1.53	1.19	
	3M	2.75		-0.83	-0.58	0.75	0.69	0.59		0.84	1.11	
	5M	1.96		-1.73	-1.41	-0.22	-0.50	-0.47		-0.33	-1.01	
On the glass base	30cm	2.66		-1.47	-0.30	3.37	2.59	2.92		5.87	3.50	
	1M	0.85		1.65	-0.30	1.95	2.45	2.45		4.25	-0.01	
	2M	2.16		-2.19	-0.90	2.51	1.70	2.05		4.84	2.25	
	3M	2.10		-2.51	-1.43	2.09	1.11	1.31		4.16	0.65	
	5M	1.18		-3.07	-1.99	0.91	0.02	0.35		2.98	0.05	

4G/3G MIMO 2												
Frequency (MHz)	698 ~803	703 ~803	824 ~894	880 ~960	1710 ~1880	1850 ~1990	1920 ~2170	2305 ~2360	2490 ~2690	3410 ~3490	3400 ~3600	
Efficiency (%)												
In free space	30cm	72.01		45.99	34.09	73.58	68.59	33.44		63.58	38.76	
	1M	70.55		56.19	39.21	66.54	52.25	45.40		59.01	33.16	
	2M	64.18		42.21	29.69	60.55	33.71	27.32		50.17	29.20	
	3M	59.38		37.78	27.57	53.47	29.71	23.89		42.78	24.46	
	5M	51.25		31.84	23.14	41.89	22.94	18.50		32.70	17.59	
On the 2mm ABS base	30cm	65.93		36.48	26.86	60.26	38.12	30.54		56.90	32.33	
	1M	71.92		52.85	31.51	62.46	48.02	42.26		59.79	34.38	
	2M	58.76		34.28	23.40	49.55	31.05	24.95		44.87	24.37	
	3M	56.15		31.80	21.72	44.39	29.14	22.18		38.32	20.40	
	5M	46.95		25.27	18.25	34.28	21.13	16.89		29.24	14.68	
On the glass base	30cm	43.02		18.05	11.86	37.76	27.71	27.15		58.38	30.74	
	1M	49.79		15.28	8.64	38.20	35.24	37.66		63.96	32.37	
	2M	38.34		17.81	10.33	31.05	22.58	22.19		46.02	23.13	
	3M	36.20		16.54	9.59	27.82	20.43	18.90		39.31	18.78	
	5M	30.66		12.52	8.06	21.48	15.35	15.02		29.99	13.94	
Average Gain(dBi)												
In free space	30cm	-1.46		-3.39	-4.75	-1.44	-1.67	-4.84		-1.98	-4.45	
	1M	-1.52		-2.53	-4.23	-1.82	-2.84	-3.49		-2.31	-4.98	
	2M	-1.96		-3.76	-5.35	-2.29	-4.79	-5.72		-3.01	-5.70	
	3M	-2.30		-4.25	-5.68	-2.83	-5.34	-6.30		-3.70	-6.45	
	5M	-2.94		-4.99	-6.43	-3.89	-6.47	-7.41		-4.87	-7.90	
On the 2mm ABS base	30cm	-1.86		-4.41	-5.79	-2.24	-4.27	-5.21		-2.46	-5.34	
	1M	-1.44		-2.83	-5.26	-2.10	-3.21	-3.79		-2.25	-4.80	
	2M	-2.36		-4.67	-6.39	-3.10	-5.16	-6.09		-3.49	-6.59	
	3M	-2.54		-5.00	-6.72	-3.57	-5.45	-6.61		-4.18	-7.34	
	5M	-3.34		-6.01	-7.47	-4.70	-6.84	-7.78		-5.35	-8.79	
On the glass base	30cm	-3.76		-7.54	-9.36	-4.28	-5.59	-5.70		-2.35	-5.32	
	1M	-3.12		-8.39	-10.74	-4.24	-4.55	-4.27		-1.95	-4.90	
	2M	-4.26		-7.59	-9.96	-5.13	-6.48	-6.58		-3.38	-6.57	
	3M	-4.51		-7.92	-10.29	-5.61	-6.92	-7.25		-4.07	-7.53	
	5M	-5.24		-9.14	-11.05	-6.73	-8.16	-8.27		-5.24	-8.77	

Frequency (MHz)	698 ~803	703 ~803	824 ~894	880 ~960	1710 ~1880	1850 ~1990	1920 ~2170	2305 ~2360	2490 ~2690	3410 ~3490	3400 ~3600
Peak Gain(dBi)											
In free space	30cm	3.61		1.20	-0.05	3.31	3.41	-0.63		3.01	0.43
	1M	2.84		2.15	0.02	2.61	1.74	1.08		3.26	-0.68
	2M	3.11		0.98	-0.65	2.46	-0.33	-1.50		1.98	-0.82
	3M	2.78		0.35	-0.98	1.92	-0.89	-2.09		1.28	-1.57
	5M	2.14		-0.40	-1.74	0.86	-2.01	-3.19		0.12	-3.02
On the 2mm ABS base	30cm	3.09		-0.25	-0.95	2.34	0.42	-0.30		2.97	-0.92
	1M	2.30		2.38	-0.13	2.12	1.09	0.81		3.11	-0.32
	2M	2.59		-0.57	-1.55	1.49	-0.47	-1.17		1.94	-2.17
	3M	2.49		-0.90	-1.88	1.08	-0.77	-1.79		1.26	-2.92
	5M	1.62		-1.85	-2.64	-0.11	-2.15	-2.87		0.08	-4.37
On the glass base	30cm	1.04		-3.36	-5.33	0.57	-0.37	0.31		3.15	0.82
	1M	0.78		-3.92	-6.55	1.42	0.67	1.21		4.22	1.80
	2M	0.54		-3.22	-5.93	0.99	-1.26	-0.57		2.12	-0.43
	3M	0.27		-3.55	-6.25	-0.72	-1.76	-1.37		1.43	-0.97
	5M	-0.43		-4.96	-7.01	-1.89	-2.94	-2.26		0.26	-2.63

MECHANICAL

Antenna Dimensions	205.8 x 58 x 12.4mm
Housing	PC+ABS Alloy
Ingress Protection Rating	IP65
Weight	250g

ENVIRONMENTAL

Operation Temperature	-40°C to 80°C
Storage Temperature	-40°C to 90°C
Humidity	Non-condensing 65°C 95% RH

LTE BANDS				
Band Number	LTE / LTE-Advanced / WCDMA / HSPA / HSPA+ / TD-SCDMA			
	Uplink	Downlink	MIMO 1	MIMO 2
1	UL: 1920 to 1980	DL: 2110 to 2170	✗	✓
2	UL: 1850 to 1910	DL: 1930 to 1990	✓	✓
3	UL: 1710 to 1785	DL: 1805 to 1880	✓	✓
4	UL: 1710 to 1755	DL: 2110 to 2155	✓	✓
5	UL: 824 to 849	DL: 869 to 894	✓	✓
7	UL: 2500 to 2570	DL: 2620 to 2690	✓	✓
8	UL: 880 to 915	DL: 925 to 960	✗	✓
9	UL: 1749.9 to 1784.9	DL: 1844.9 to 1879.9	✓	✓
11	UL: 1427.9 to 1447.9	DL: 1475.9 to 1495.9	✗	✗
12	UL: 699 to 716	DL: 729 to 746	✓	✓
13	UL: 777 to 787	DL: 746 to 756	✓	✓
14	UL: 788 to 798	DL: 758 to 768	✓	✓
17	UL: 704 to 716	DL: 734 to 746 (LTE only)	✓	✓
18	UL: 815 to 830	DL: 860 to 875 (LTE only)	✓	✓
19	UL: 830 to 845	DL: 875 to 890	✓	✓
20	UL: 832 to 862	DL: 791 to 821	✓	✓
21	UL: 1447.9 to 1462.9	DL: 1495.9 to 1510.9	✗	✗
22	UL: 3410 to 3490	DL: 3510 to 3590	✗	✓
23	UL: 2000 to 2020	DL: 2180 to 2200 (LTE only)	✗	✓
24	UL: 1625.5 to 1660.5	DL: 1525 to 1559 (LTE only)	✓	✓
25	UL: 1850 to 1915	DL: 1930 to 1995	✓	✓
26	UL: 814 to 849	DL: 859 to 894	✓	✓
27	UL: 807 to 824	DL: 852 to 869 (LTE only)	✓	✓
28	UL: 703 to 748	DL: 758 to 803 (LTE only)	✓	✓
29	UL: -	DL: 717 to 728 (LTE only)	✓	✓
30	UL: 2305 to 2315	DL: 2350 to 2360 (LTE only)	✓	✓
31	UL: 452.5 to 457.5	DL: 462.5 to 467.5 (LTE only)	✗	✗
32	UL: -	DL: 1452 - 1496	✗	✗
35		1850 to 1910	✓	✓
38		2570 to 2620	✓	✓
39		1880 to 1920	✓	✓
40		2300 to 2400	✓	✓
41		2496 to 2690	✓	✓
42		3400 to 3600	✗	✓
43		3600 to 3800	✗	✗

*Covered bands represent an efficiency greater than 20%

3. Antenna Characteristics

3.1. GPS-GLONASS-GALILEO Antenna

3.1.1. Test Setup



3.1.2. GPS-GLONASS-GALILEO Return Loss

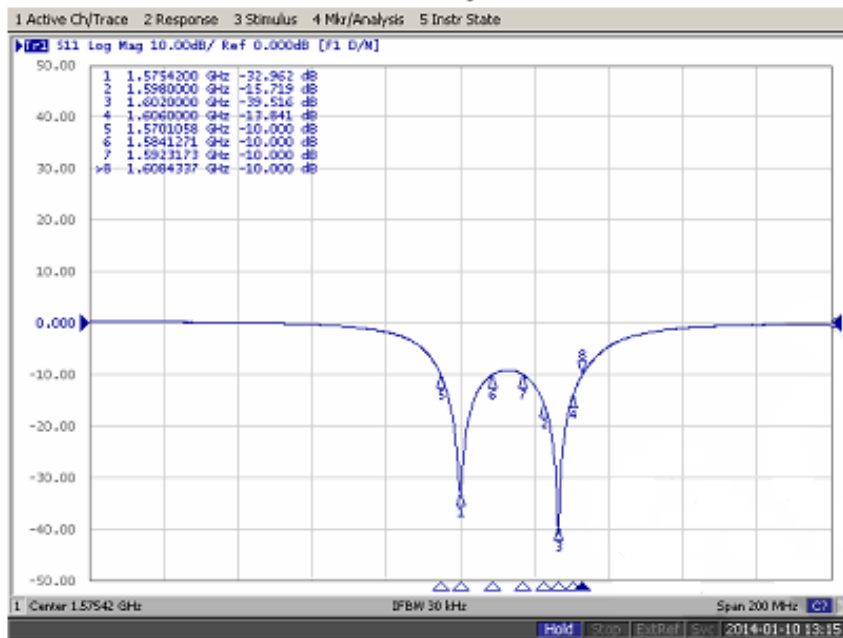

Return Loss : -32.9 dB @ 1575.42MHz, -39.5 dB @ 1602MHz

3.1.3. GPS-GLONASS-GALILEO Smith Chart

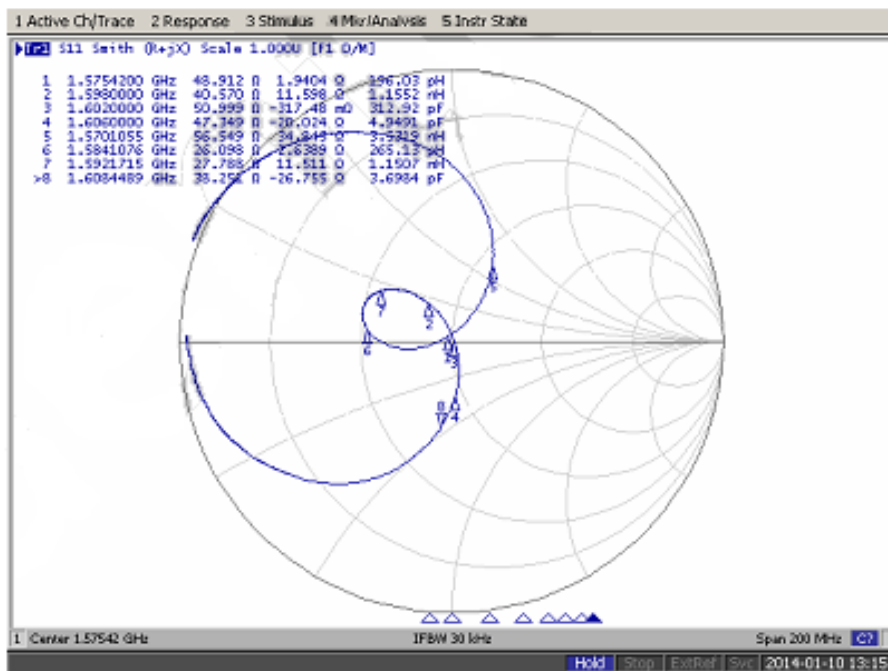

Impedance : 48.9+j1.9 Ohm@ 1575.42MHz, 50.9-j0.3 Ohm@ 1602MHz

3.1.4. GPS-GLONASS-GALILEO Gain Pattern

Gain pattern @ 1575.42MHz

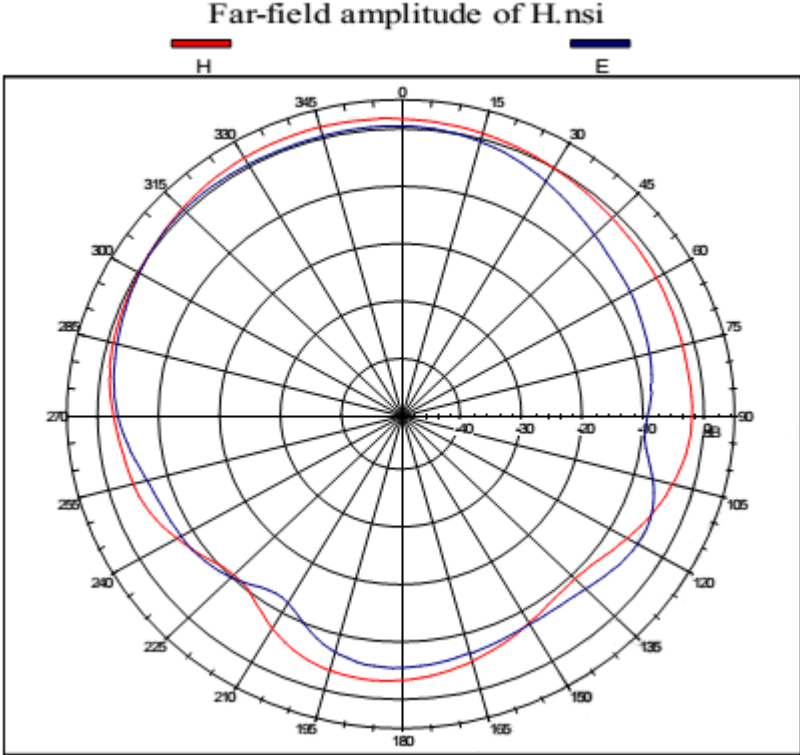

Gain pattern @ 1602MHz

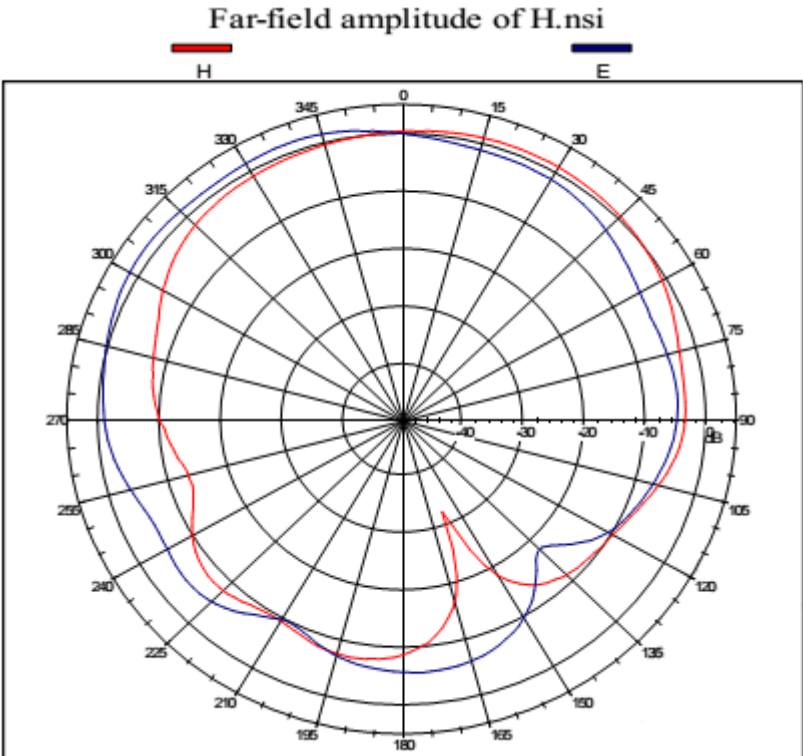

Gain Pattern Data				
Angle (°)	1575.42 MHz		1602 MHz	
	H	E	H	E
-90	-2.65	-3.35	-10.17	-1.12
-76	-0.98	-1.65	-7.82	0.16
-60	-0.15	-0.23	-4.64	1.65
-46	0.94	0.64	-2.01	1.62
-30	1.85	0.49	-0.90	1.59
-16	2.03	0.39	-0.39	1.63
0	1.67	0.44	0.37	-0.10
16	0.82	-0.69	0.90	-1.31
30	-0.23	-2.91	0.89	-1.56
46	-1.38	-5.56	0.16	-3.28
60	-1.90	-6.83	-1.12	-5.34
76	-2.49	-9.09	-3.33	-5.26
90	-2.50	-9.82	-3.93	-5.24

3.1.5. GPS-GLONASS-GALILEO LNA Noise Figure

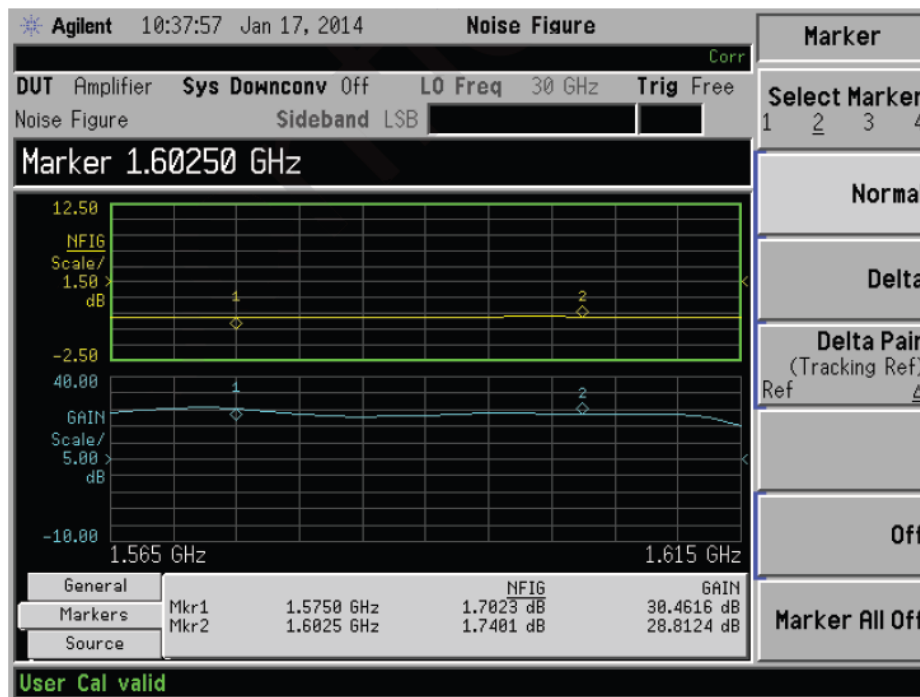

3.2. LTE Antennas

3.2.1. Test Setup

In free space



On 2mm ABS base

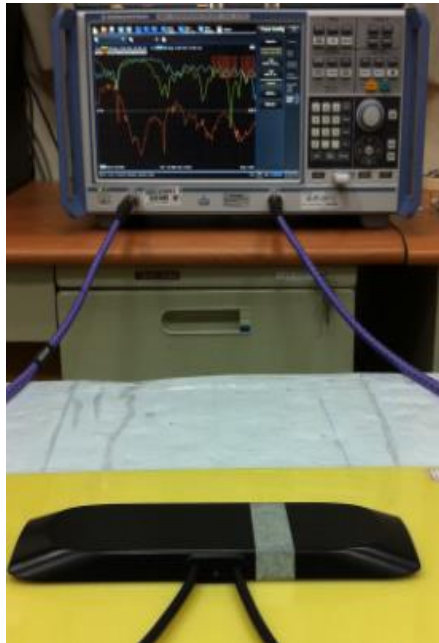

On the glass base

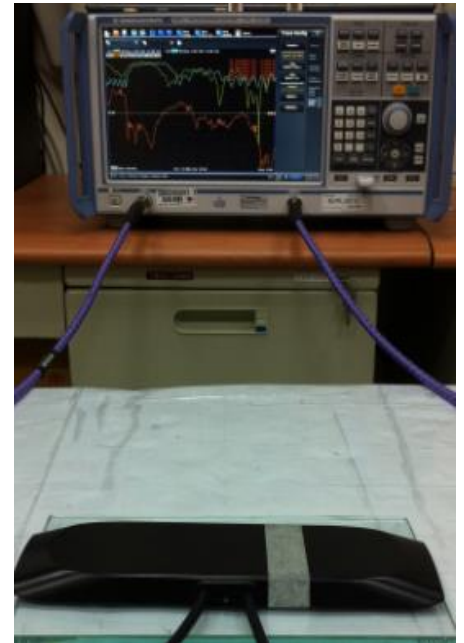

3.2.2. LTE Antenna Return Loss

Setup in the free space with 2 meters cable length

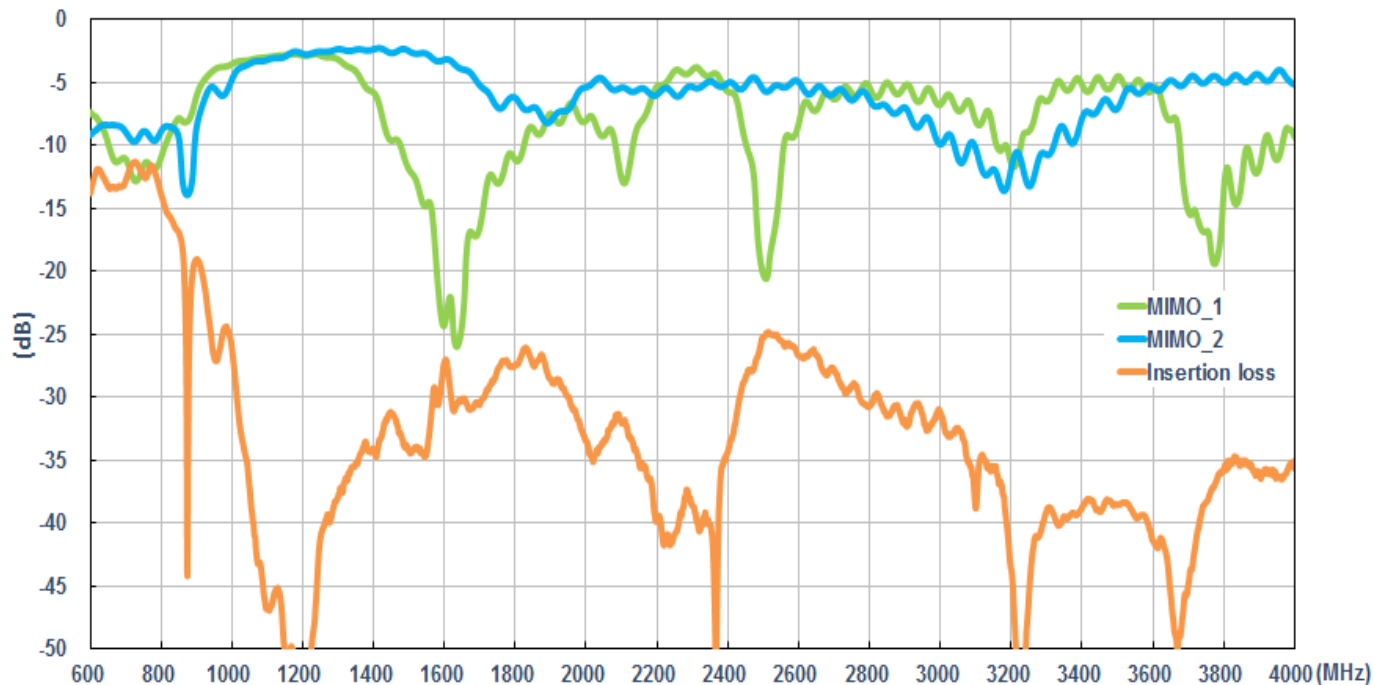

Setup on the 2mm ABS base with 2 meters cable length

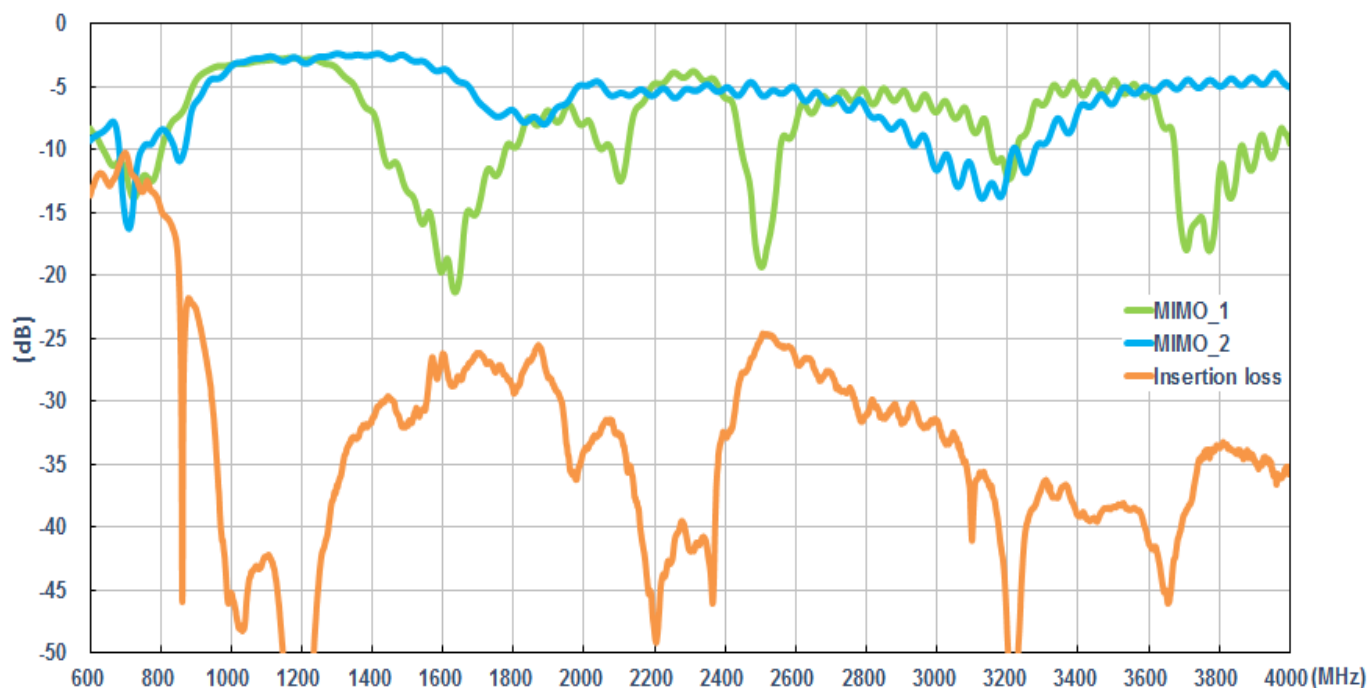

Setup on the glass base with 2 meters cable length

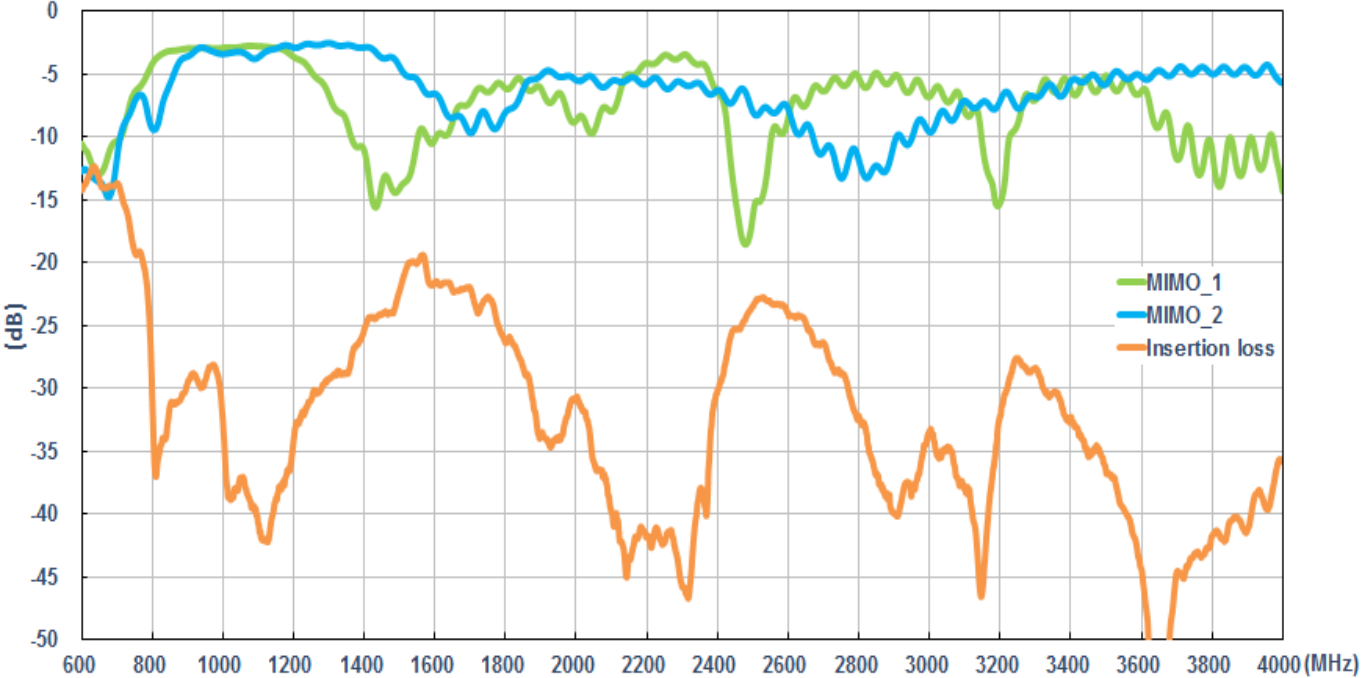

3.2.3. LTE Antenna Efficiency

MIMO 1

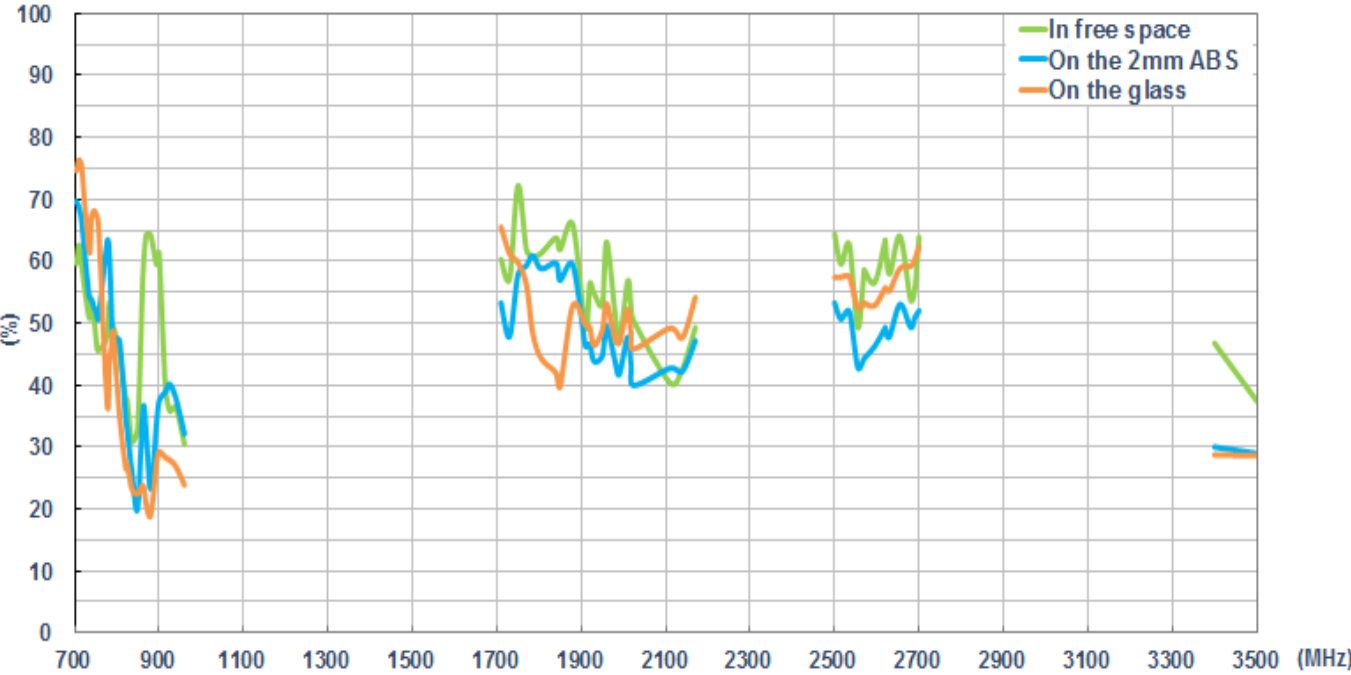

MIMO 2

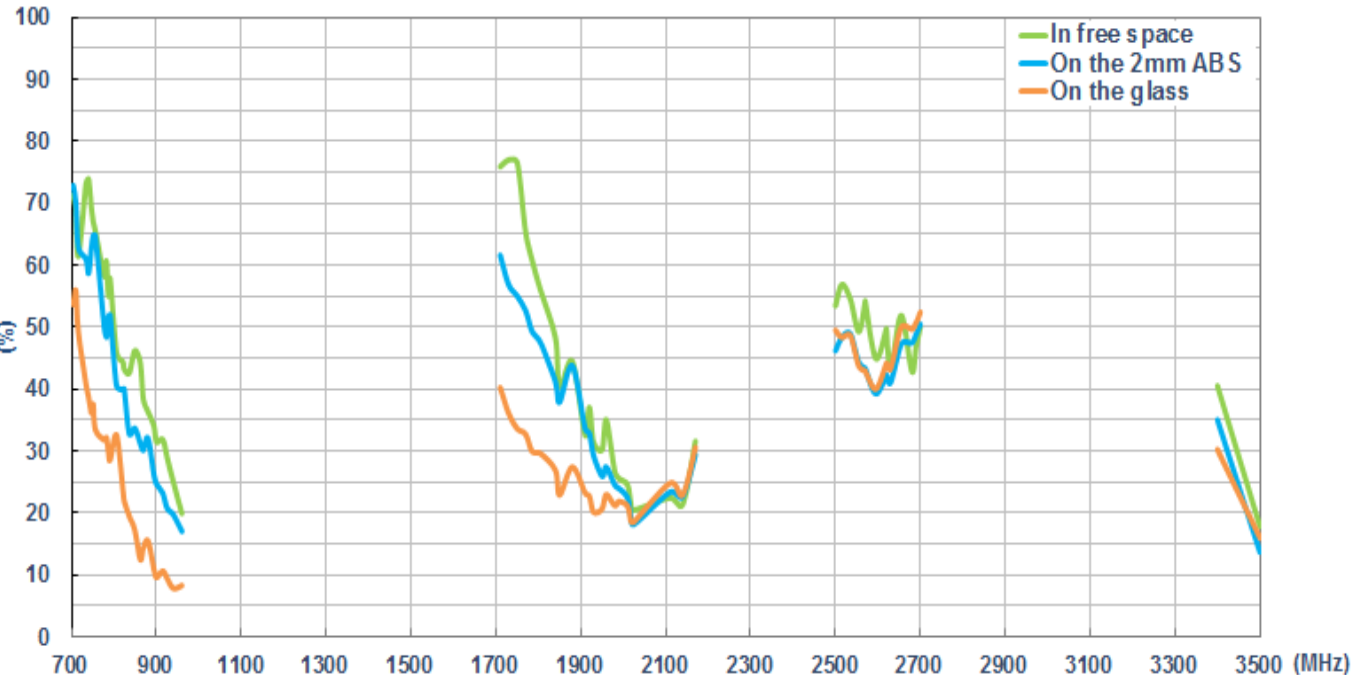

3.2.4. LTE Antenna Average Gain

MIMO 1

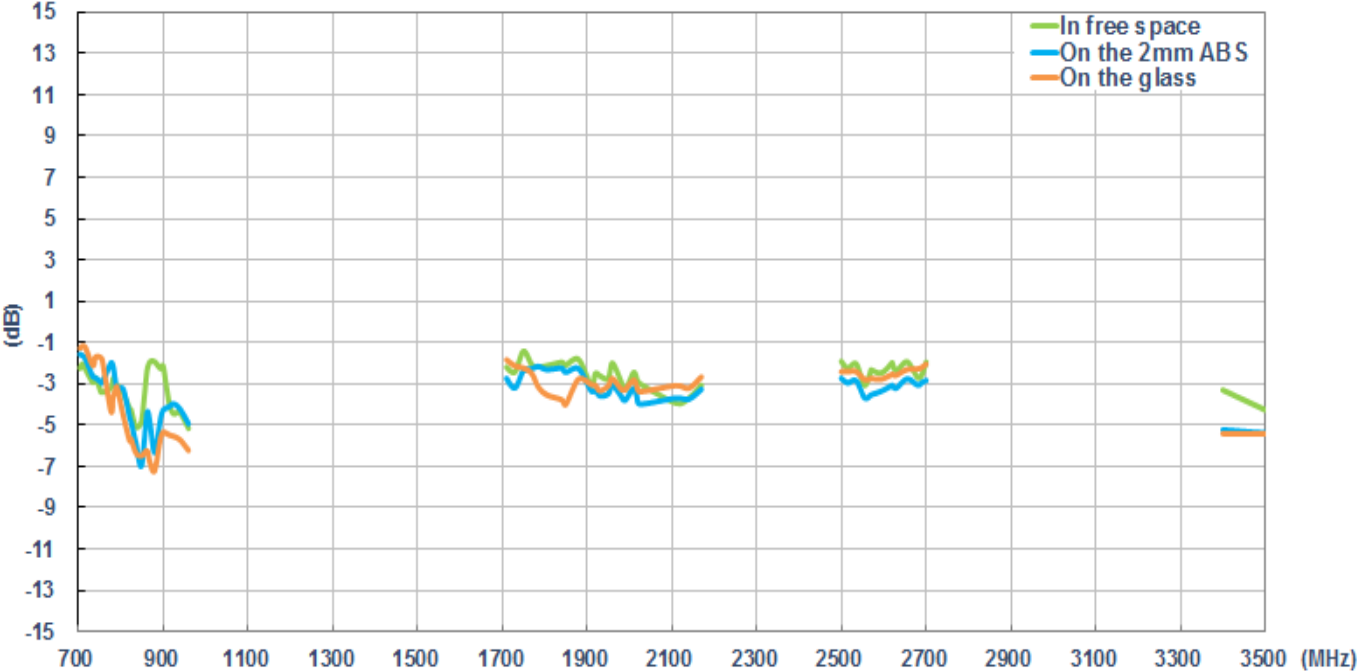

MIMO 2

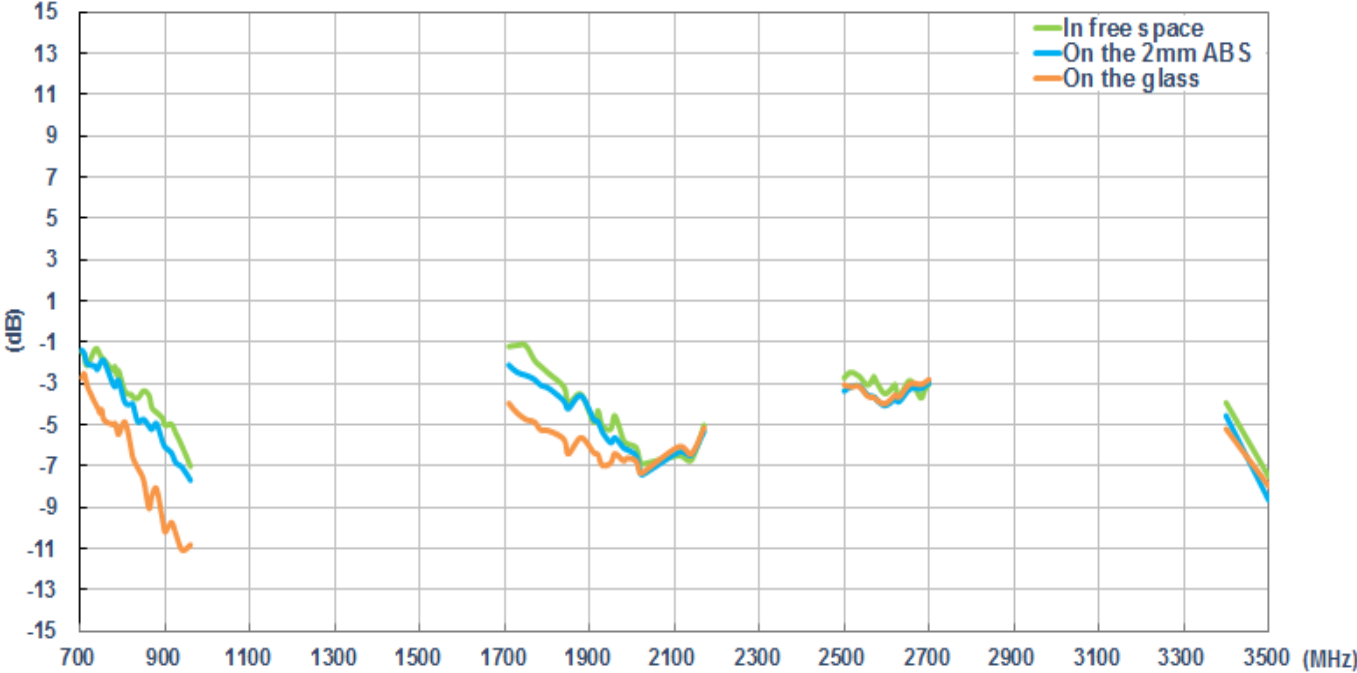

3.2.5. LTE Antenna Peak Gain

MIMO 1

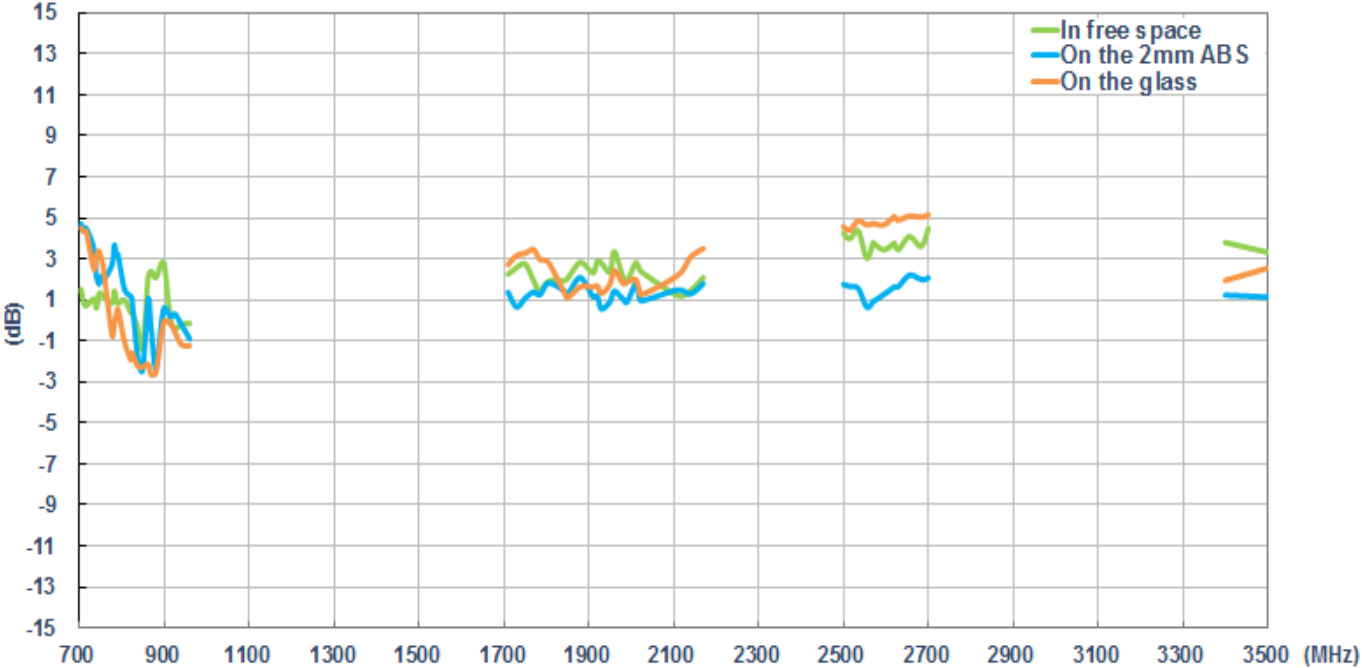

MIMO 2

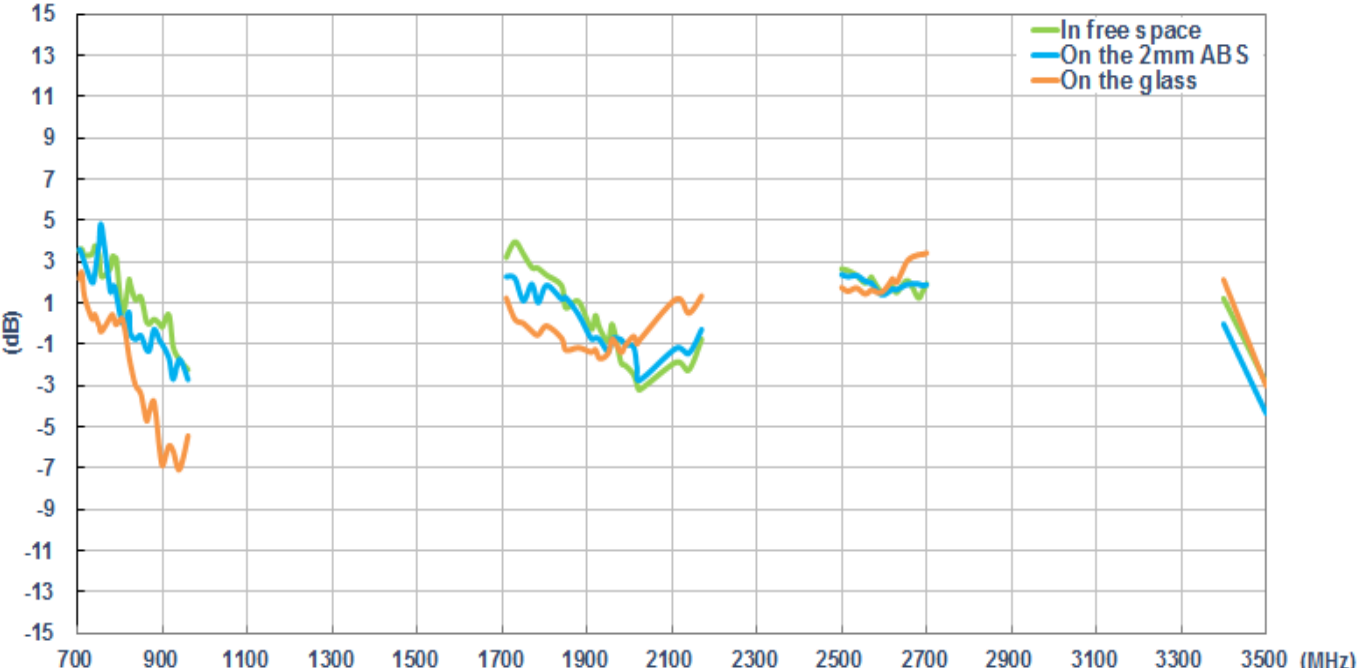

3.2.6. Test Setup for Antenna Radiation Pattern (ETS Anechoic chamber)

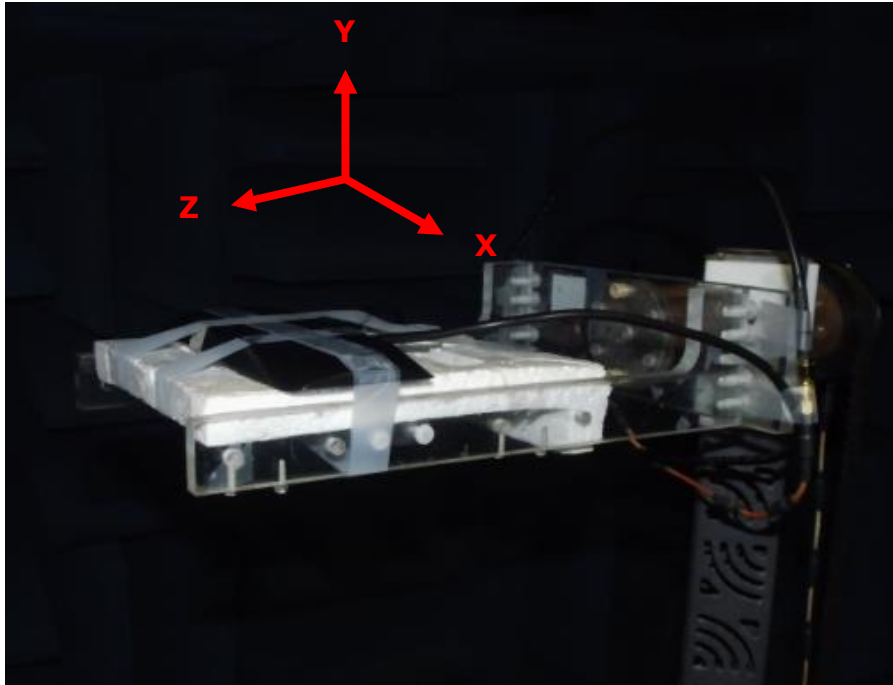

In free space

3.2.7. 2D Radiation pattern (Antenna #1 with 2M cable length in free space)

XY Plane

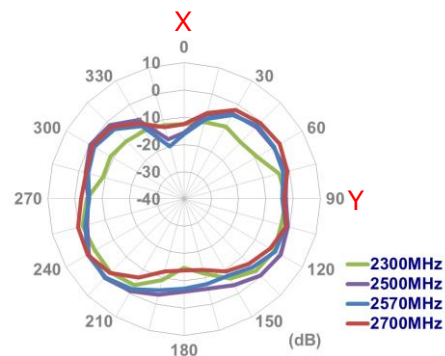
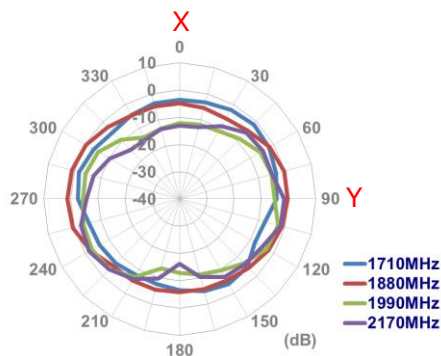
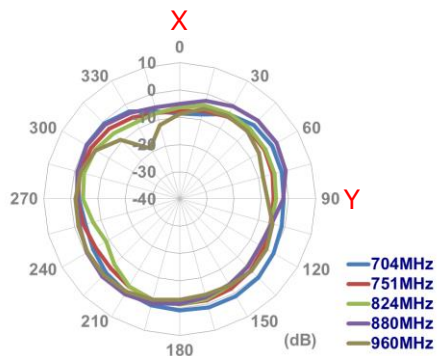

XZ Plane

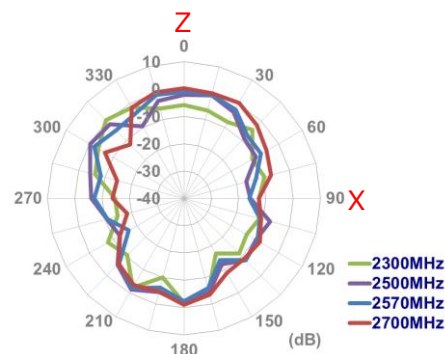
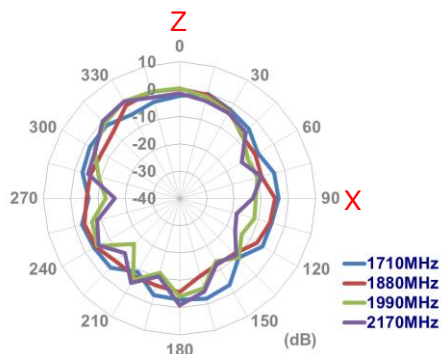
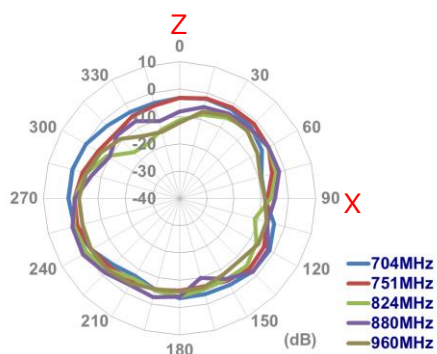

YZ Plane

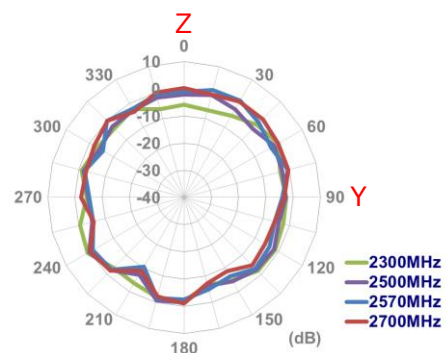
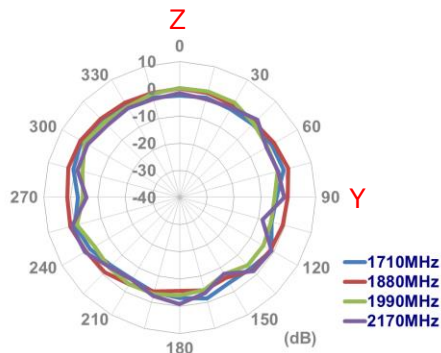
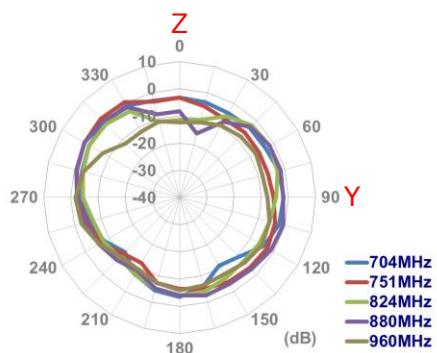

3.2.8. 2D Radiation pattern (Antenna #2 with 2M cable length in free space)

XY Plane

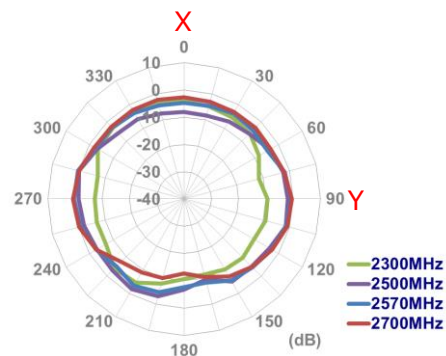
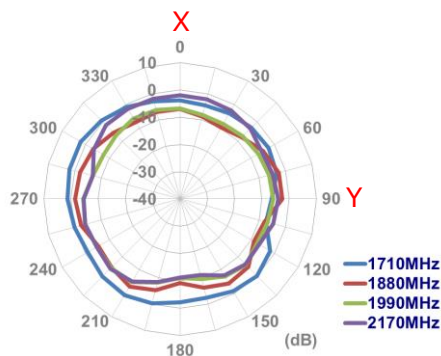
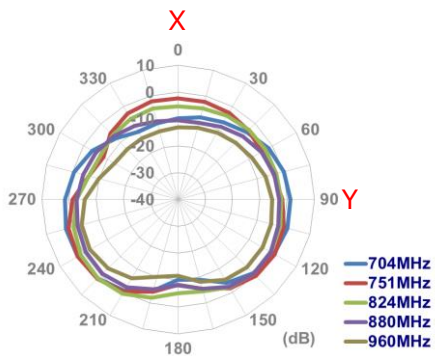

XZ Plane

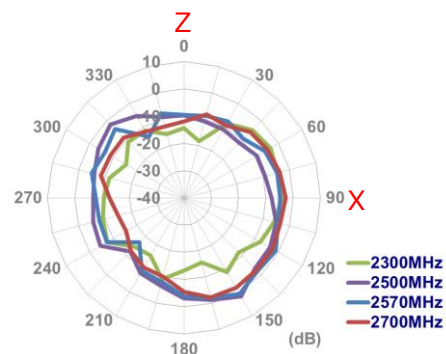
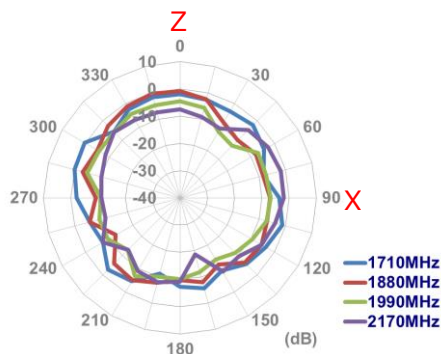
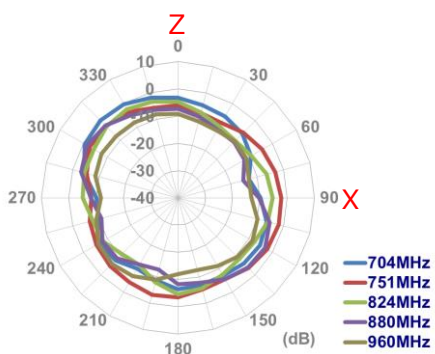

YZ Plane

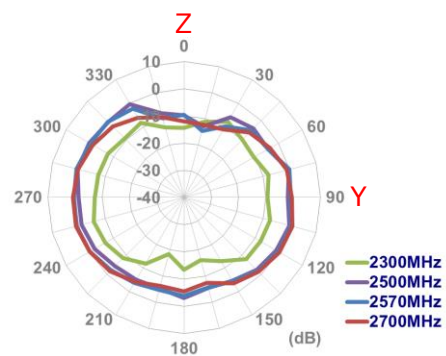
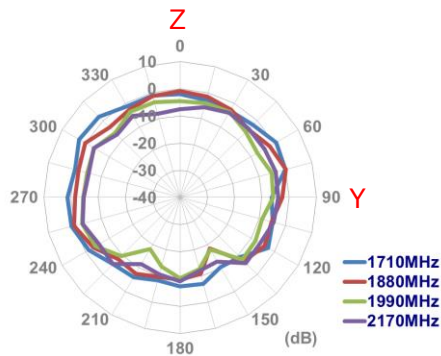
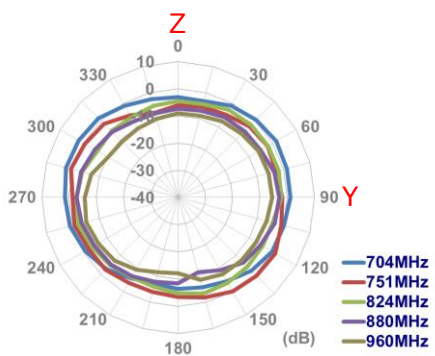

3.2.9. Test Setup for Antenna Radiation Pattern (ETS Anechoic chamber)

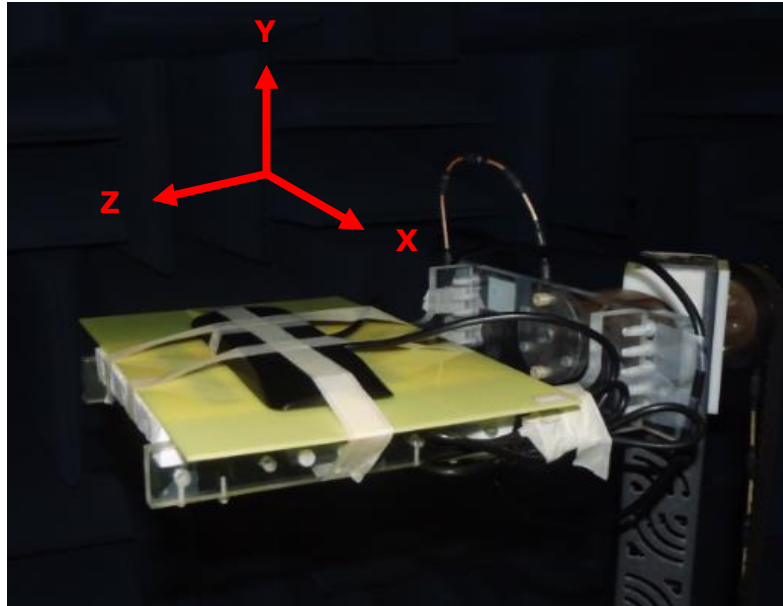

On the 2mm ABS base

3.2.10. 2D Radiation pattern (Antenna #1 with 2M cable length on the 2mm ABS)

XY Plane

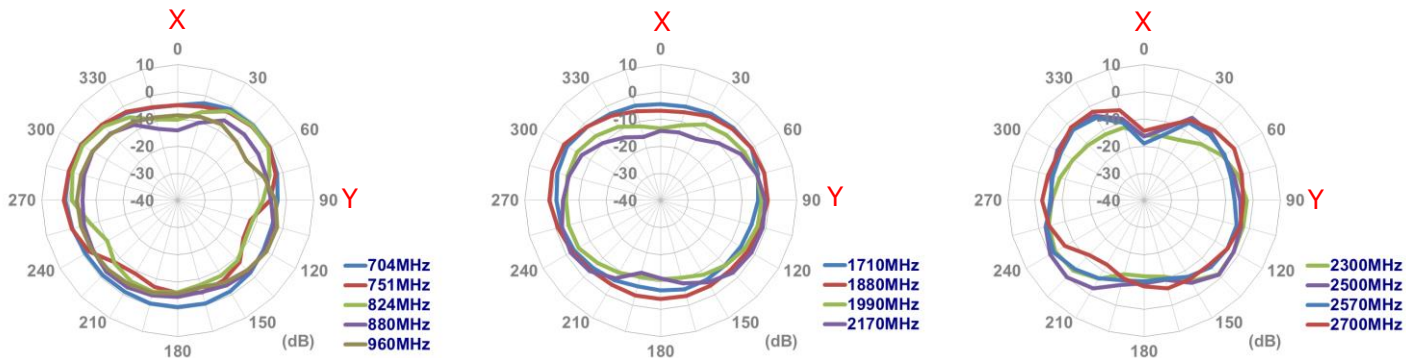

XZ Plane

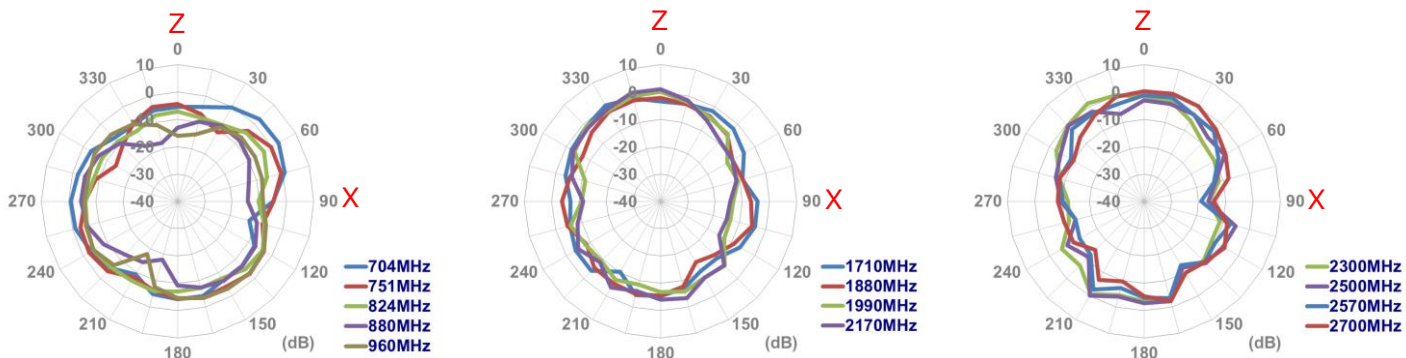

YZ Plane

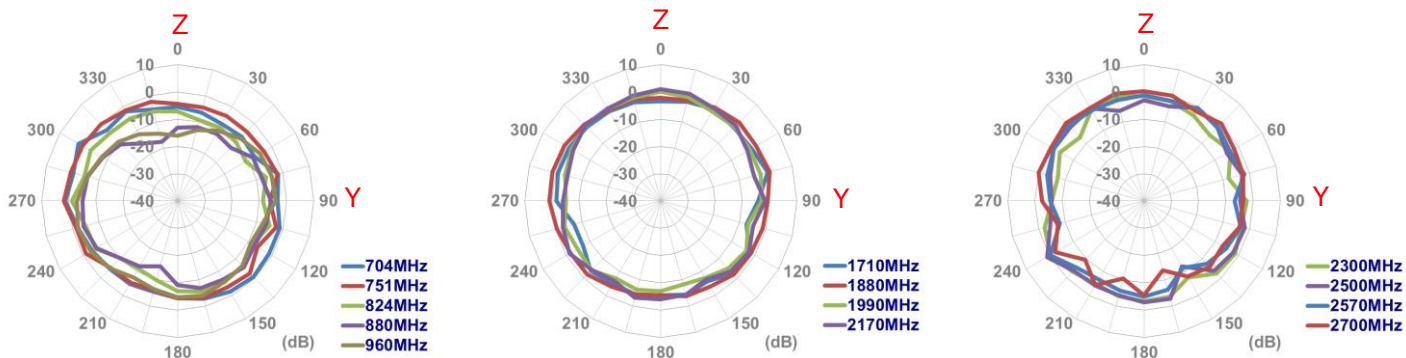

3.2.11. 2D Radiation pattern (Antenna #2 with 2M cable length on the 2mm ABS)

XY Plane

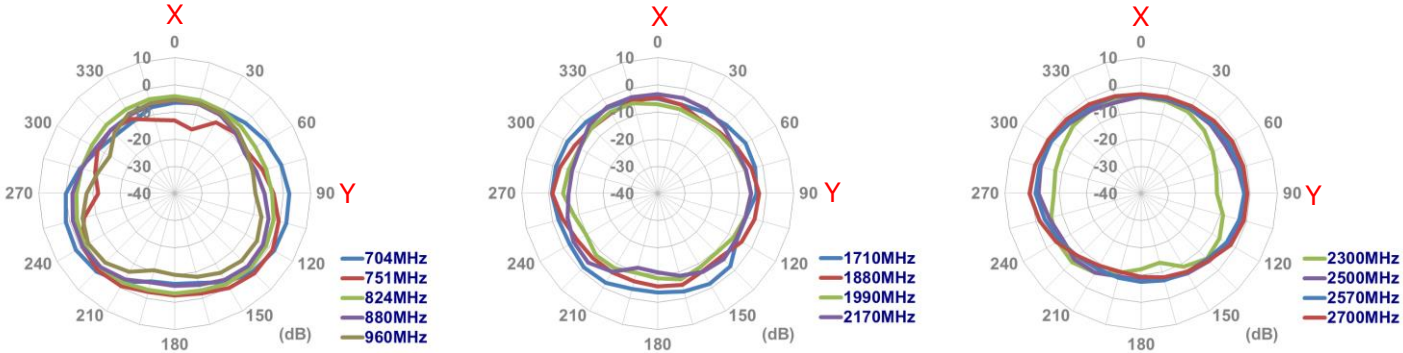

XZ Plane

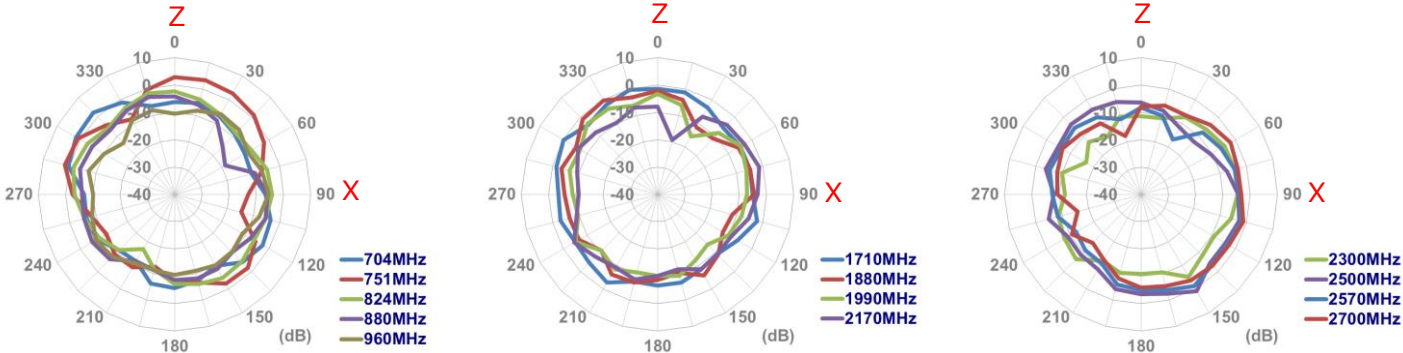

YZ Plane

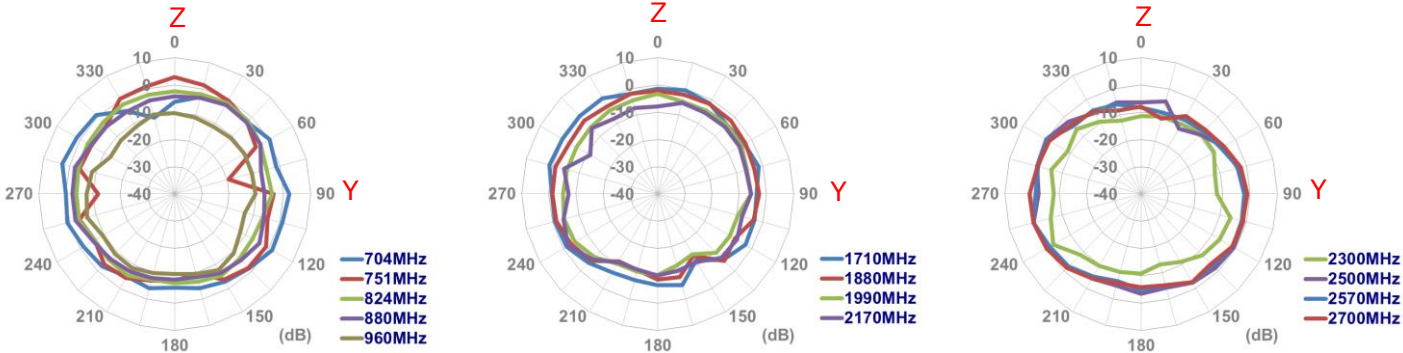

3.2.12. Test Setup for Antenna Radiation Pattern (ETS Anechoic chamber)

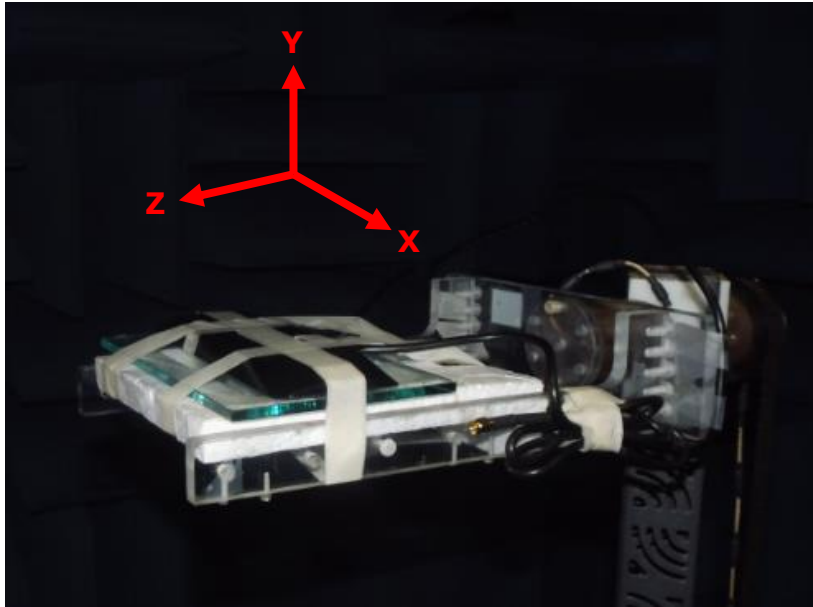

On the glass base

3.2.13. 2D Radiation pattern (Antenna #1 with 2M cable length on the glass)

XY Plane

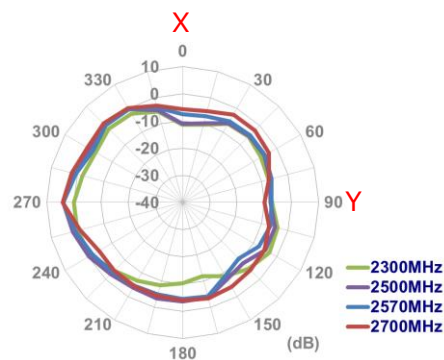
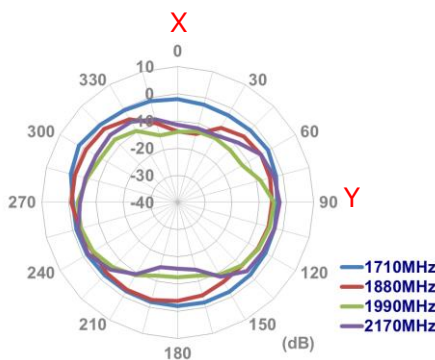
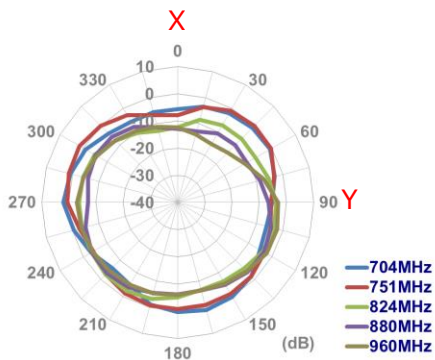

XZ Plane

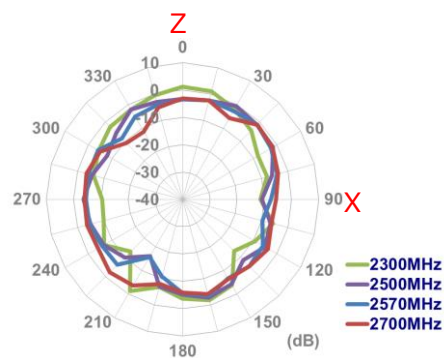
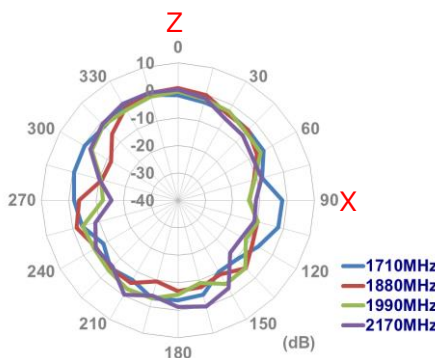
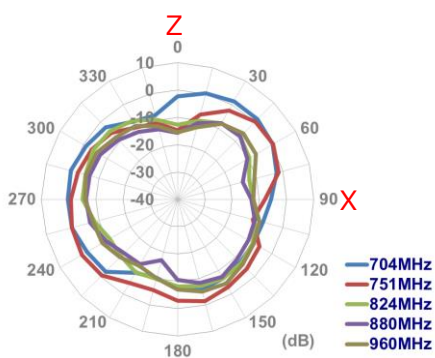

YZ Plane

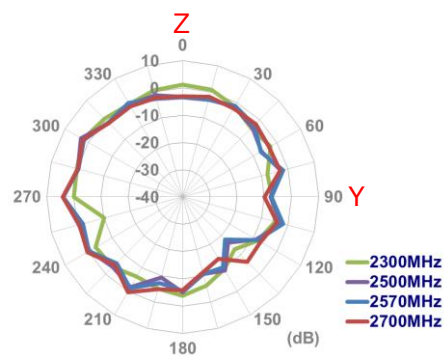
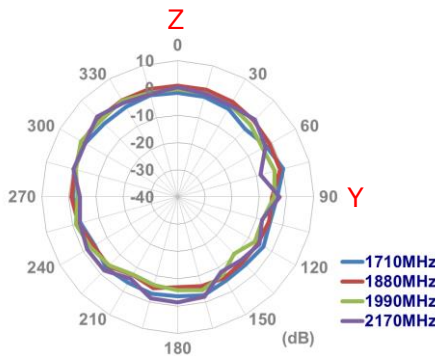
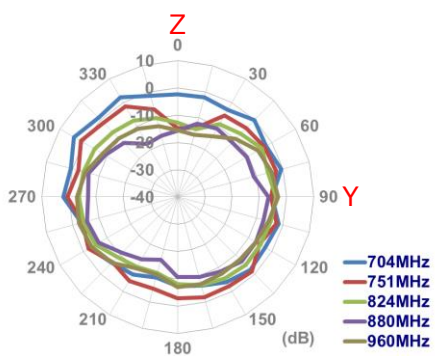

3.2.14. 2D Radiation pattern (Antenna #2 with 2M cable length on the glass)

XY Plane

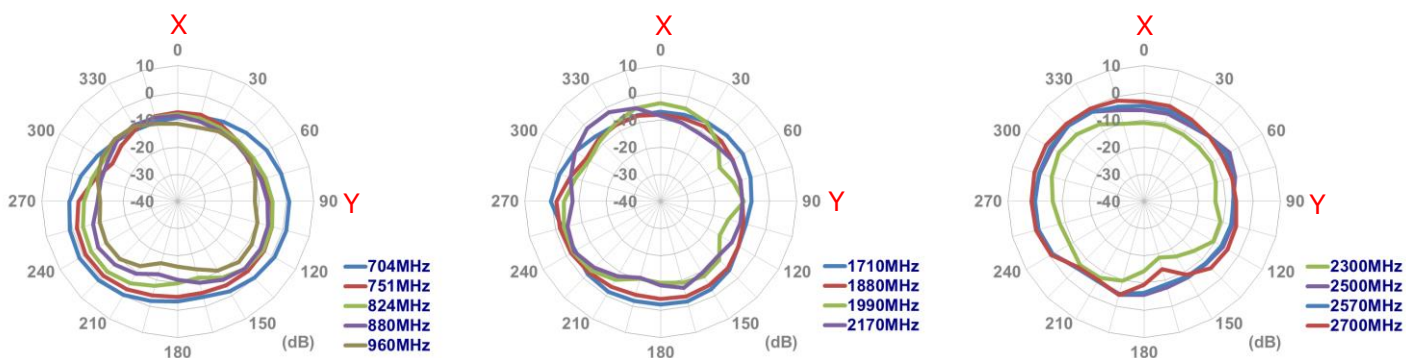

XZ Plane

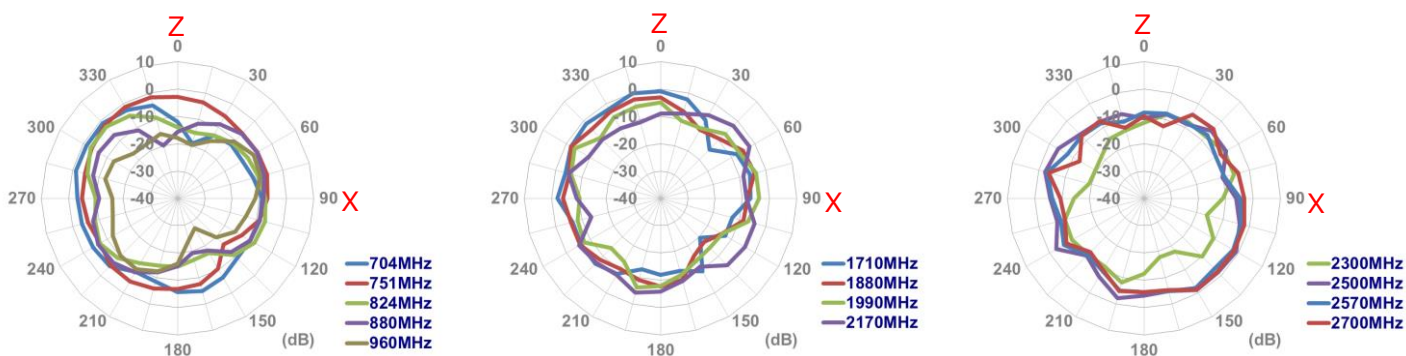

YZ Plane

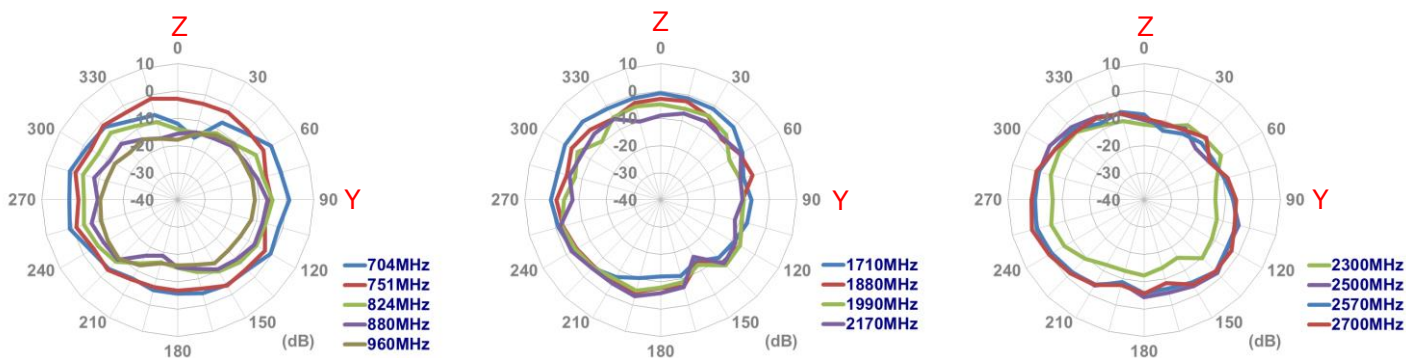

4. Drawing

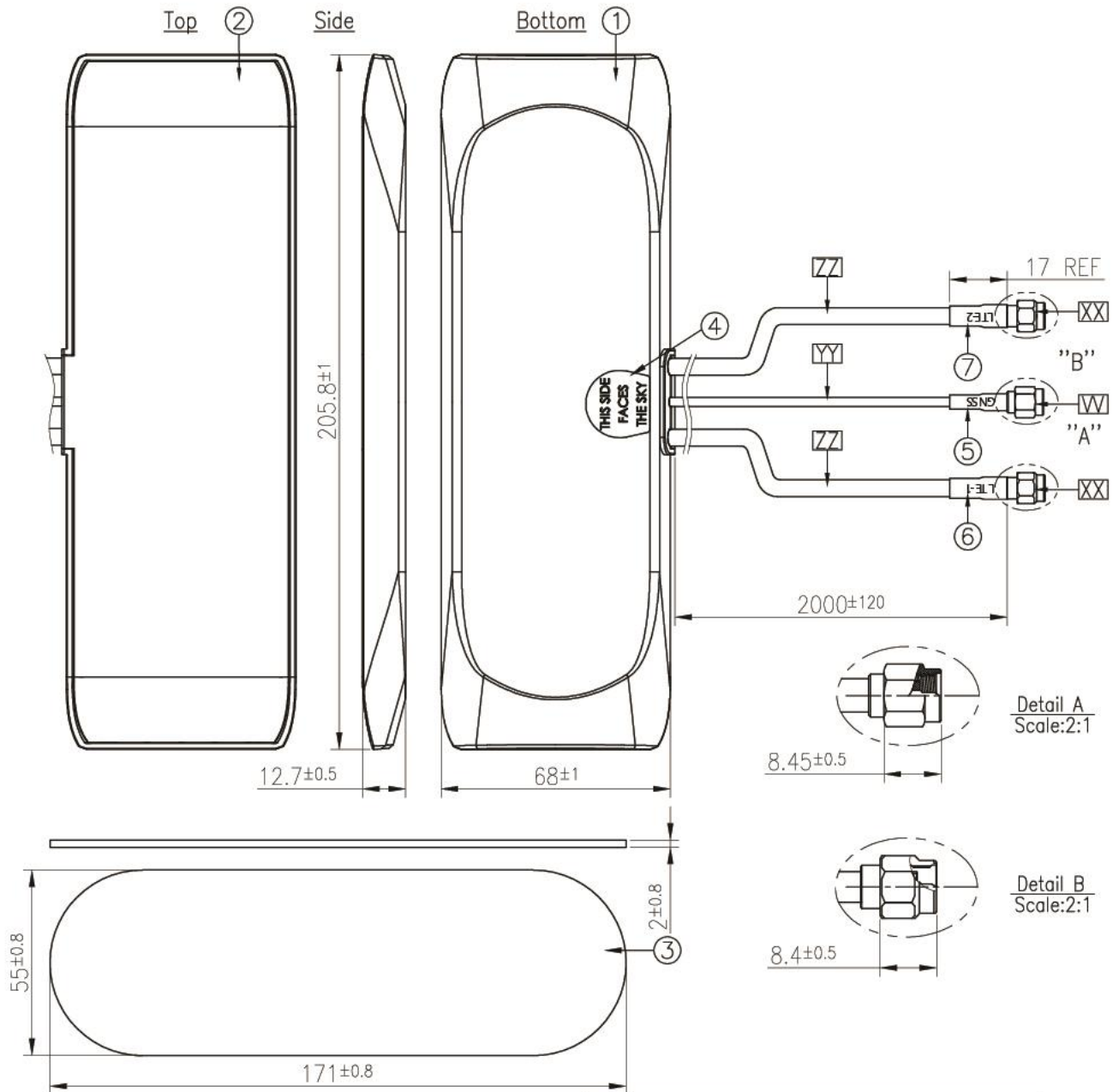

Name	Material	Finish	QTY
1 Housing Top MA240	ABS	Black	1
2 Housing Bottom MA240	ABS	Black	1
3 3M Double Sided Adhesive With Foam	3M9448+CR4305	White Liner	1
4 Clear Label	PET	White	1
5 Heat Shrink Tube (GNSS)	PE	Blue Tube/White Text	1
6 Heat Shrink Tube (LTE-1)	PE	Red Tube/White Text	1
7 Heat Shrink Tube (LTE-2)	PE	Red Tube/White Text	1

Name	Spec	Finish	QTY
W Connector Type	SMA(M)ST	Au Plated	1
XX Connector Type	SMA(M)ST	Au Plated	2
YY Cable Type	RG 174	Black	1
ZZ Cable Type	NFC200	Black	2

5. Packaging

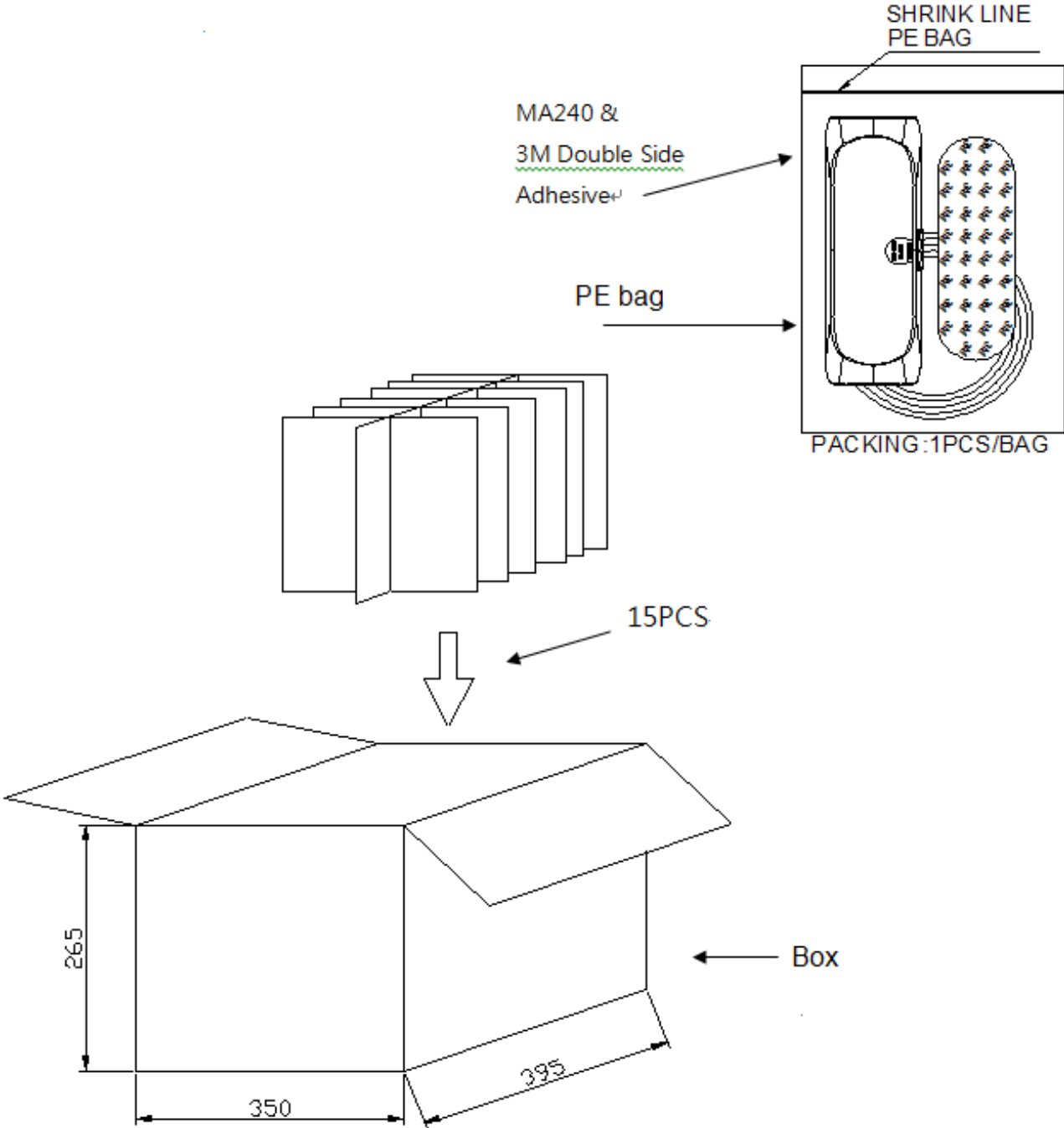

6. Application Note (LTE ANTENNA Antenna)

The MA240 antenna measurement with difference cable length and difference environments, the performance is shown as below,

6.1. In free Space

6.1.1. Return loss (ANTENNA_1 in free space)

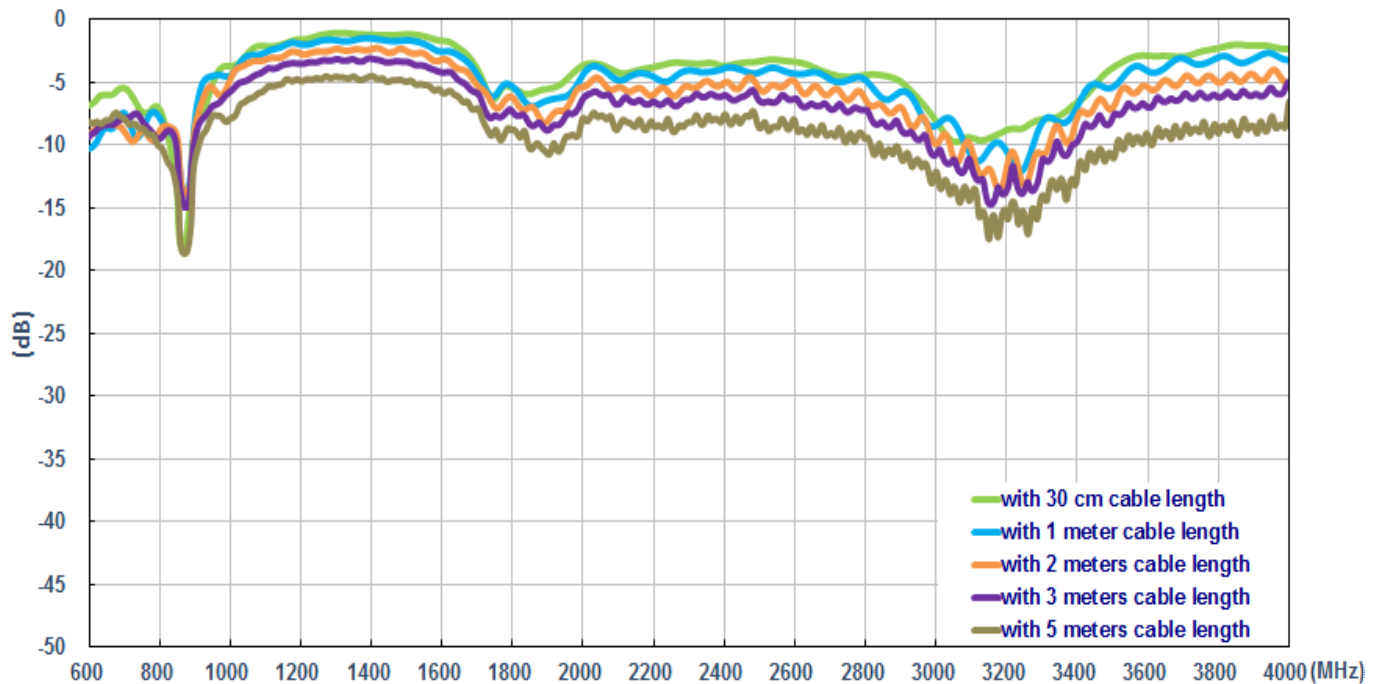

6.1.2. Return loss (ANTENNA_2 in free space)

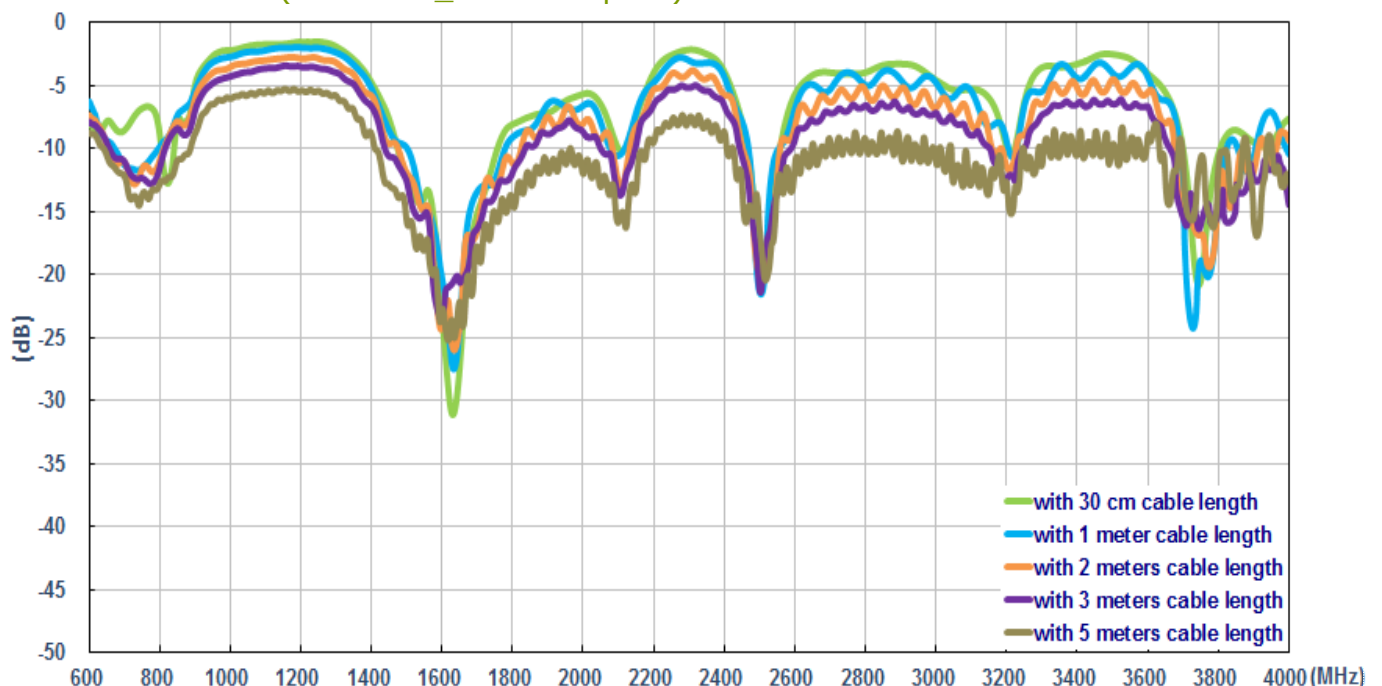

6.1.3. Insertion loss (in free space)

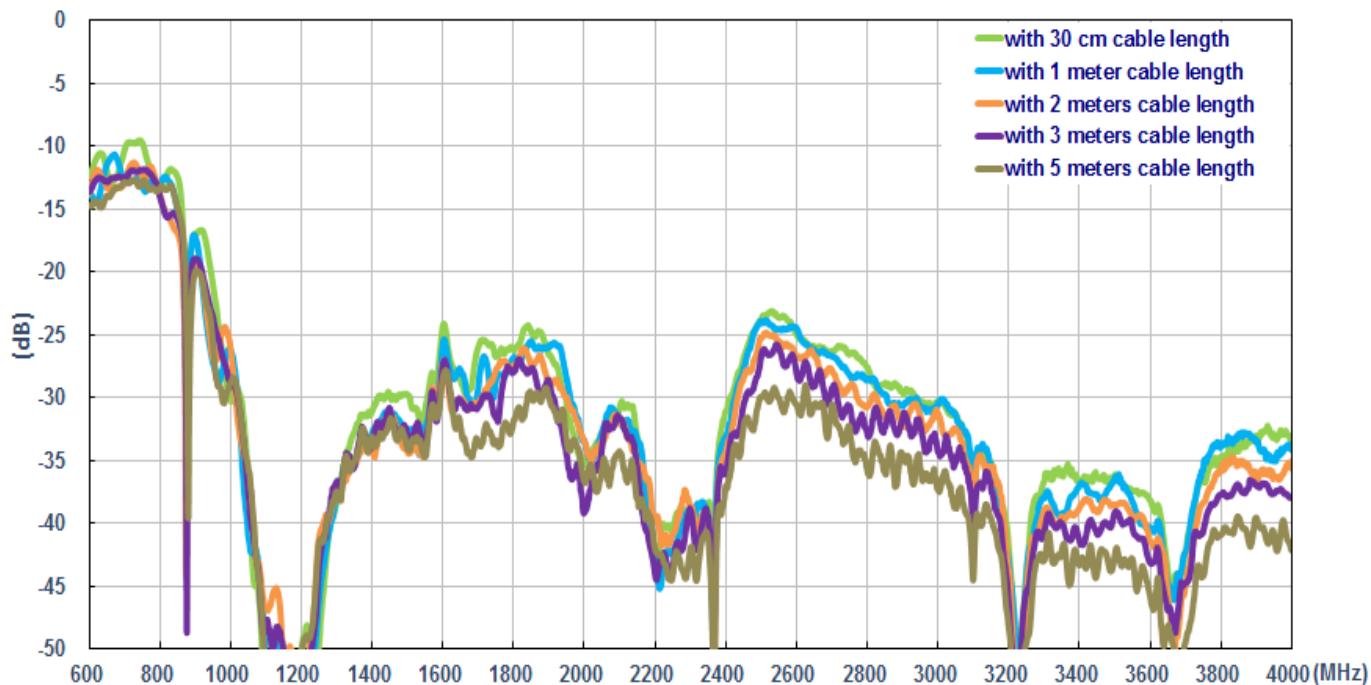

6.1.4. Efficiency (ANTENNA_1 in free space)

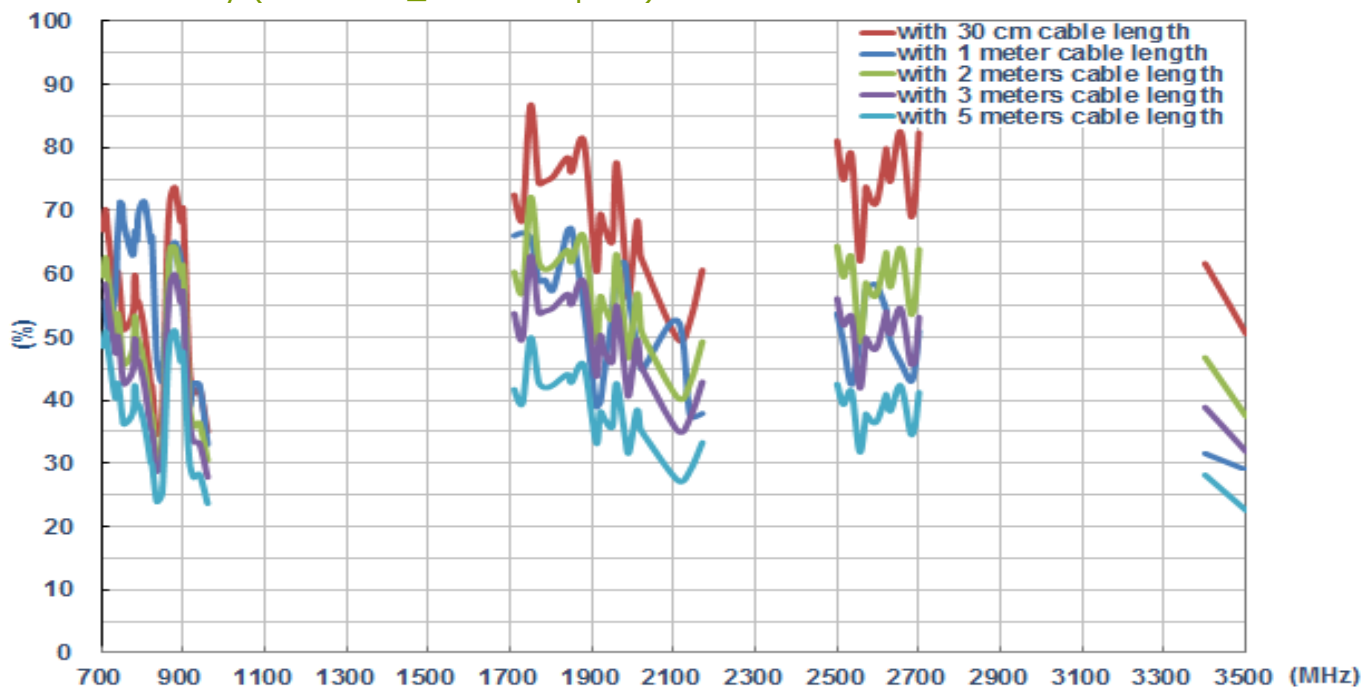

6.1.5. Efficiency (ANTENNA_2 in free space)

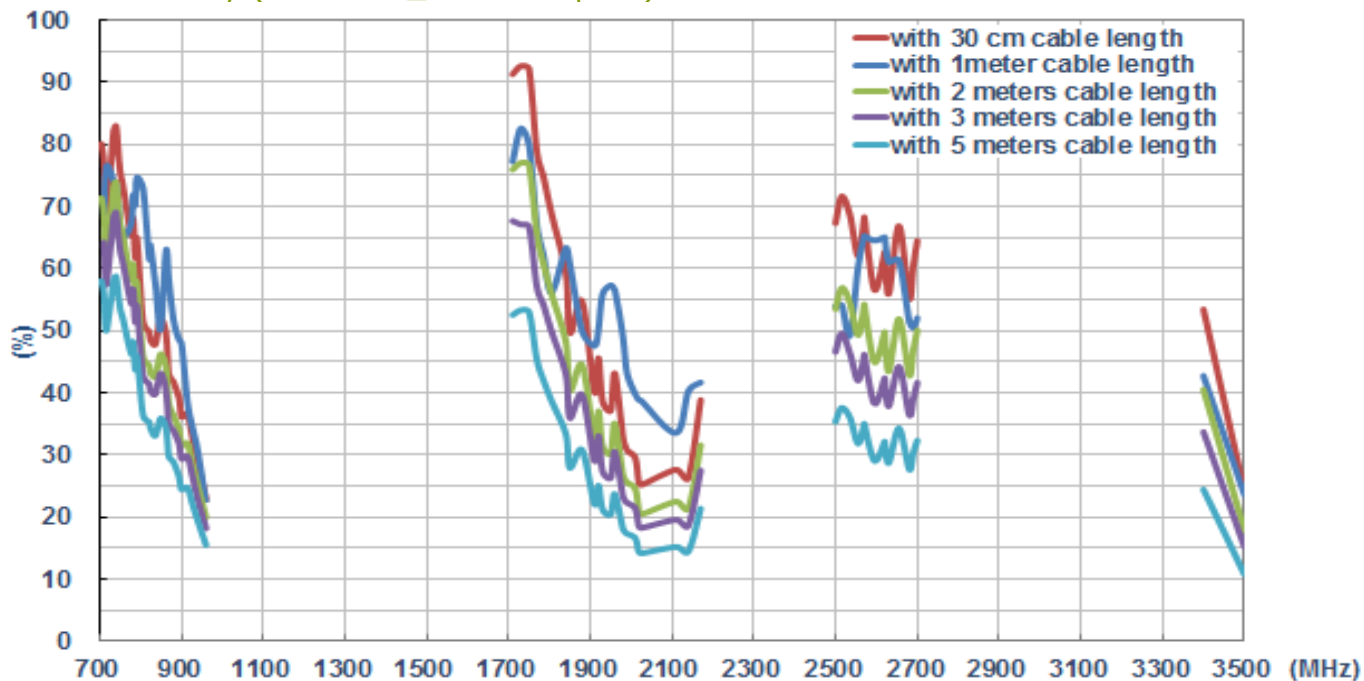

6.1.6. Average Gain (ANTENNA_1 in free space)

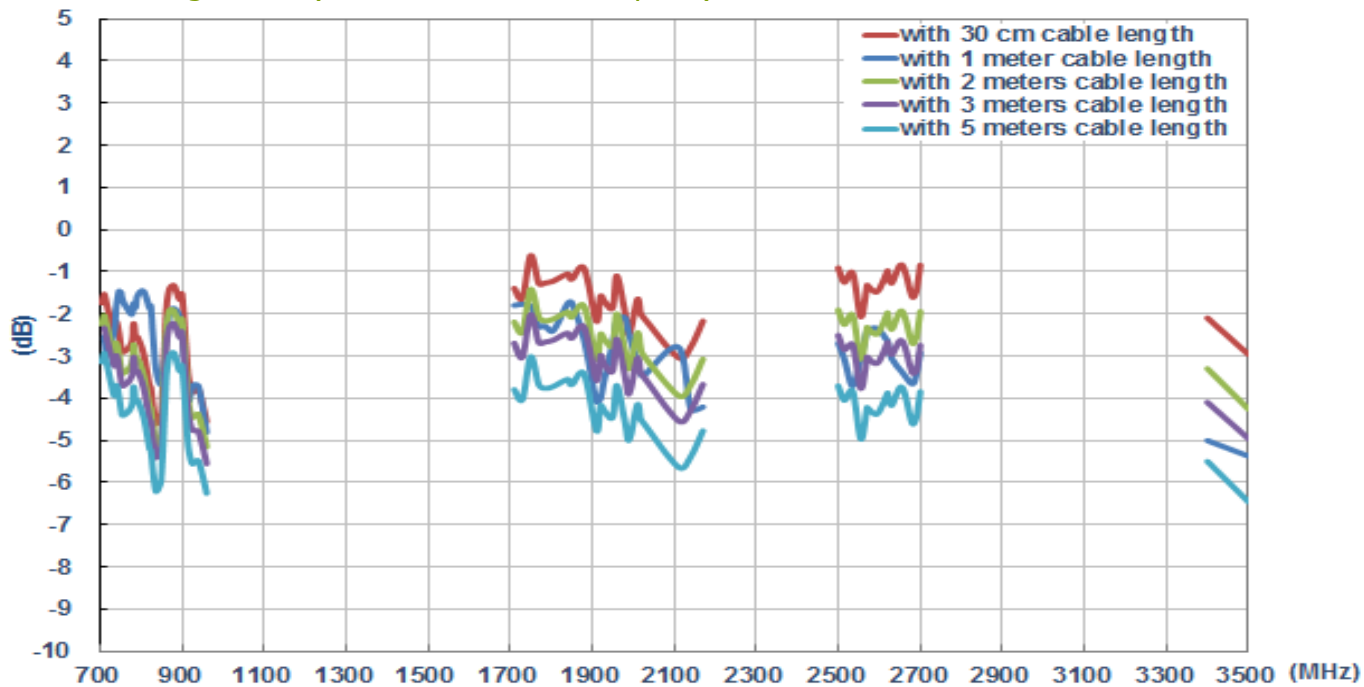

6.1.7. Average Gain (ANTENNA_2 in free space)

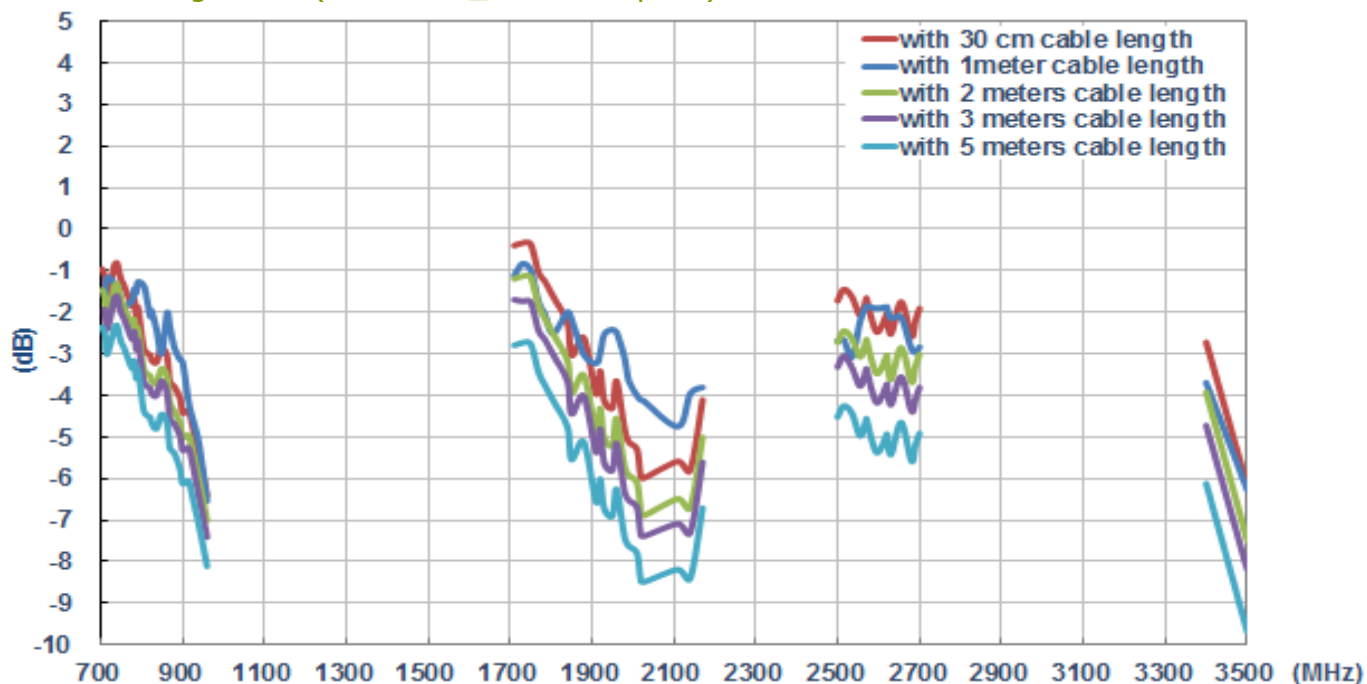

6.1.8. Peak Gain (ANTENNA_1 in free space)

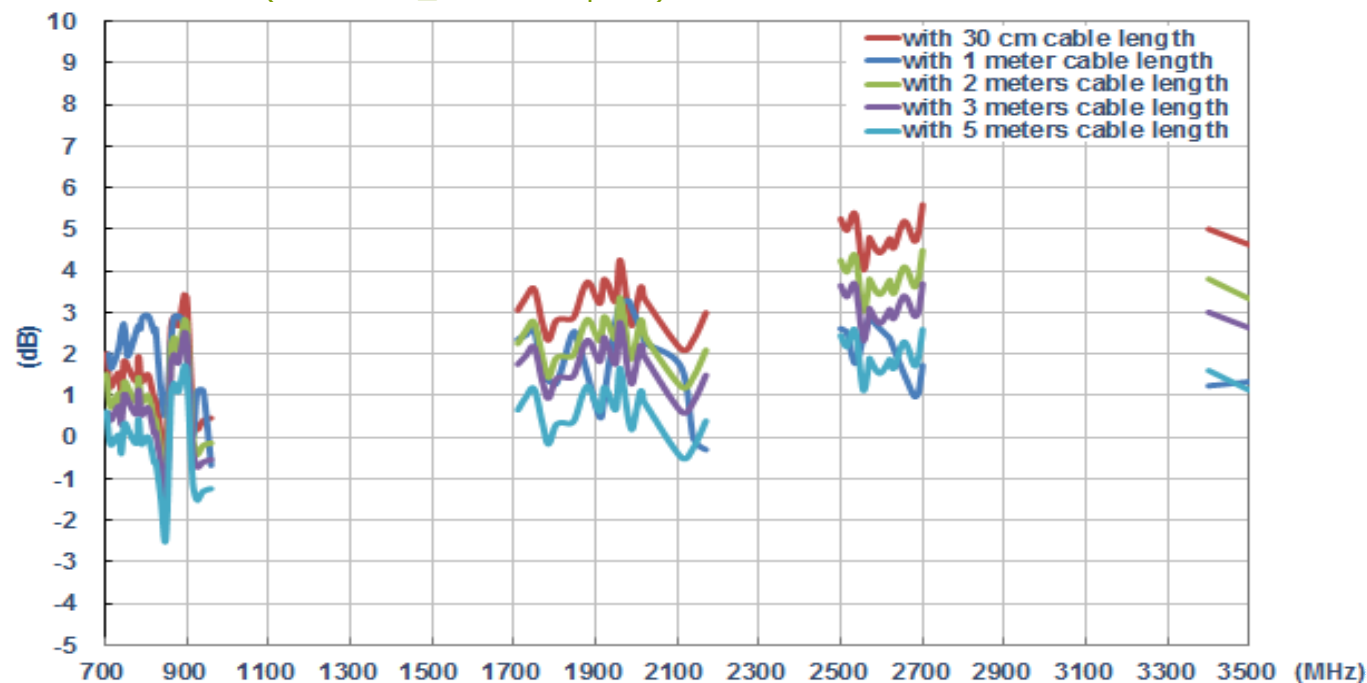

6.1.9. Peak Gain (ANTENNA_2 in free space)

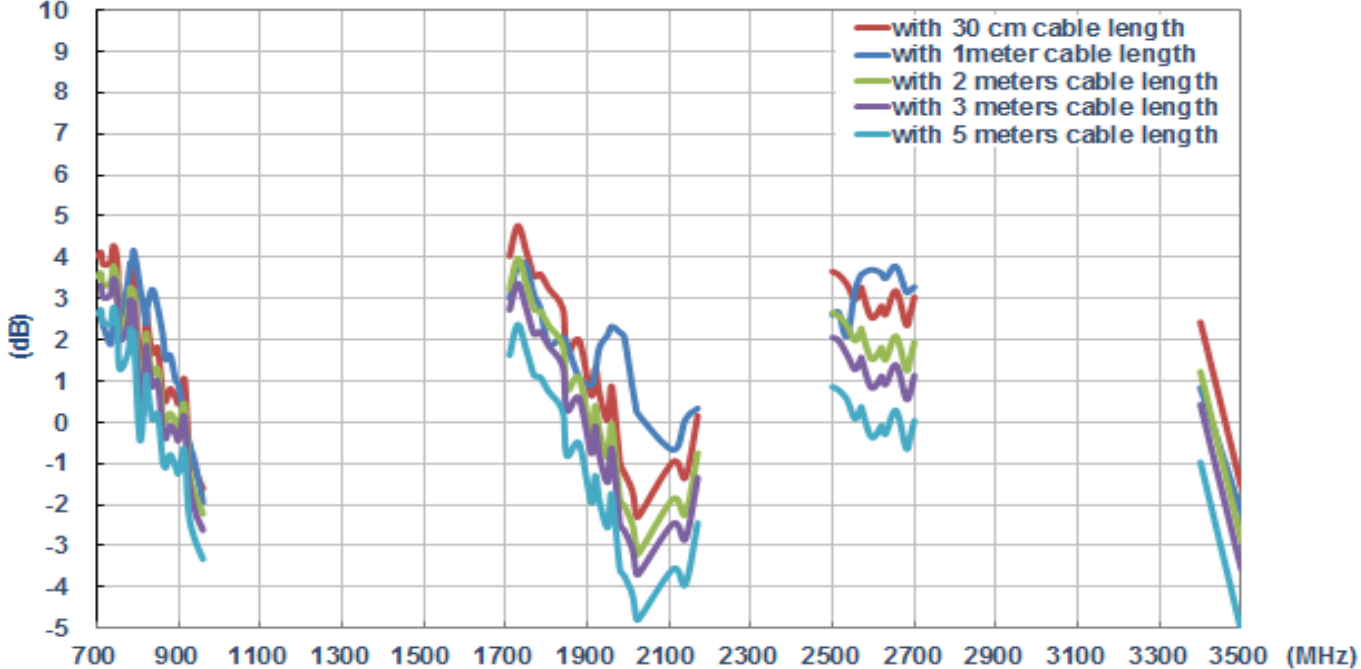

6.2. On 2mm ABS Base

6.2.1. Return loss (ANTENNA_1 on the 2mm ABS)

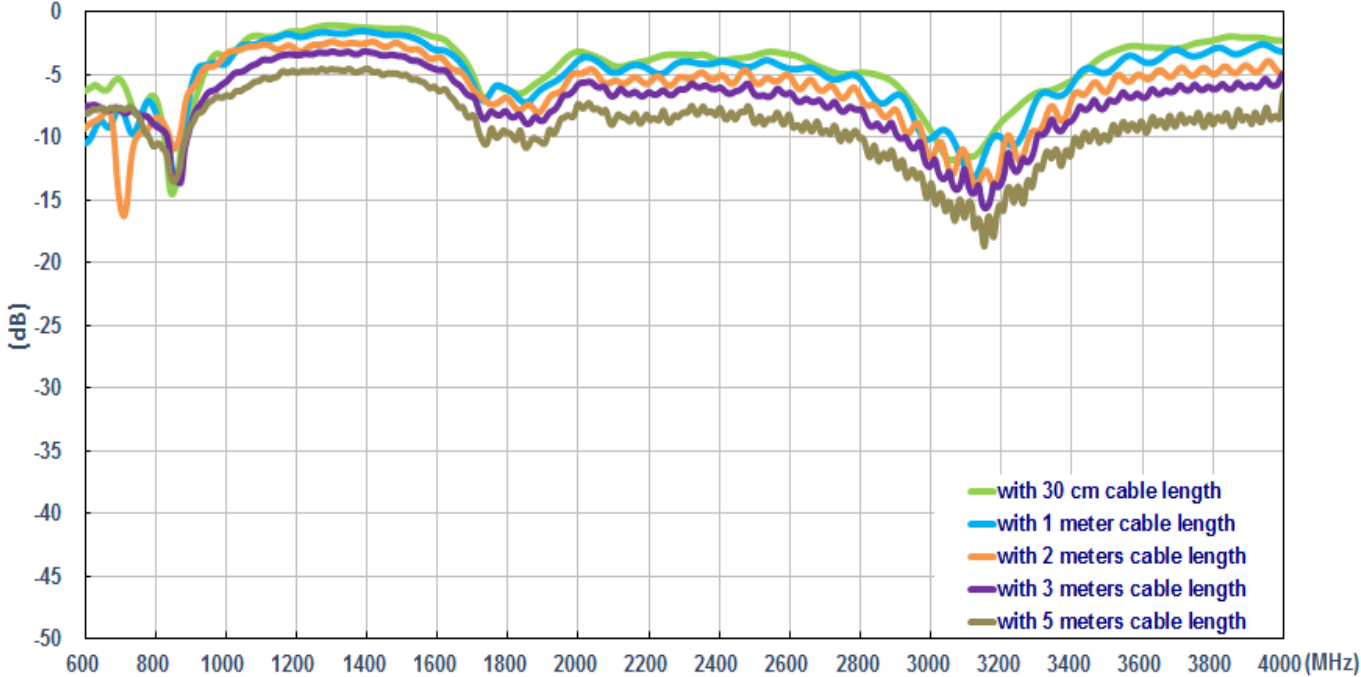

6.2.2. Return loss (ANTENNA_2 on the 2mm ABS)

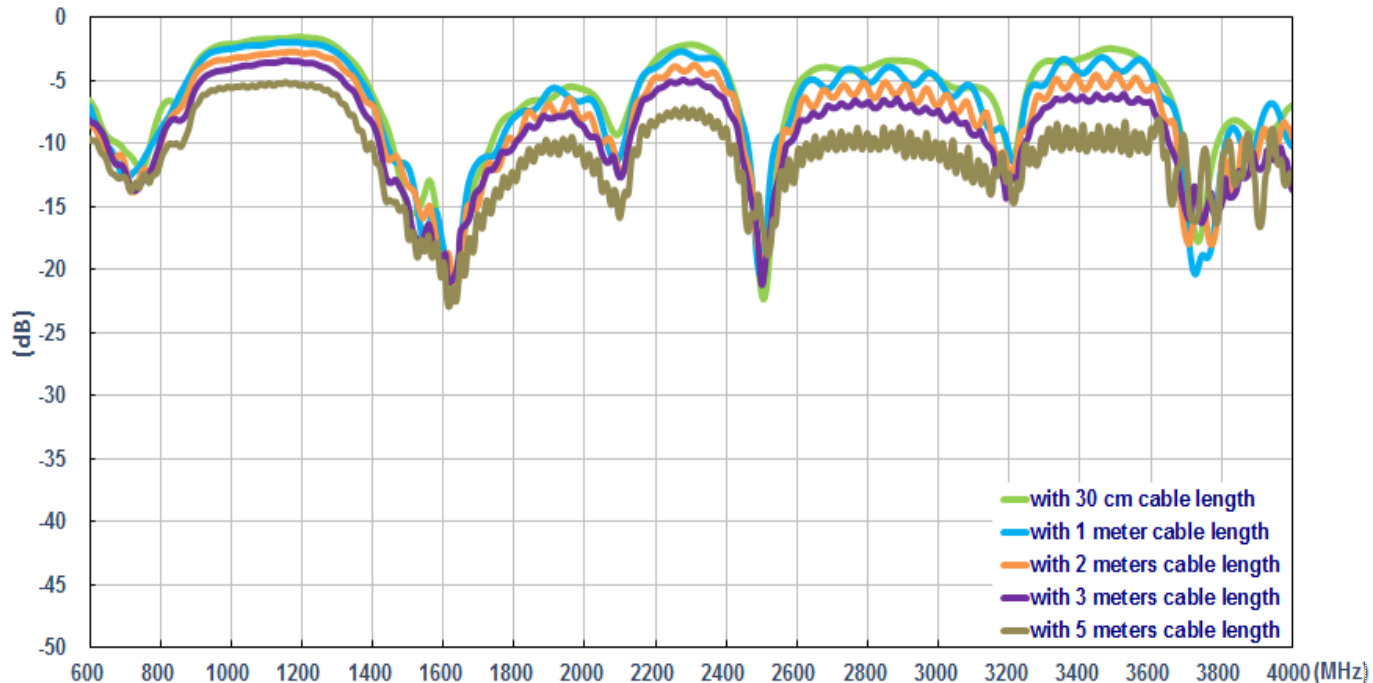

6.2.3. Insertion loss (on the 2mm ABS)

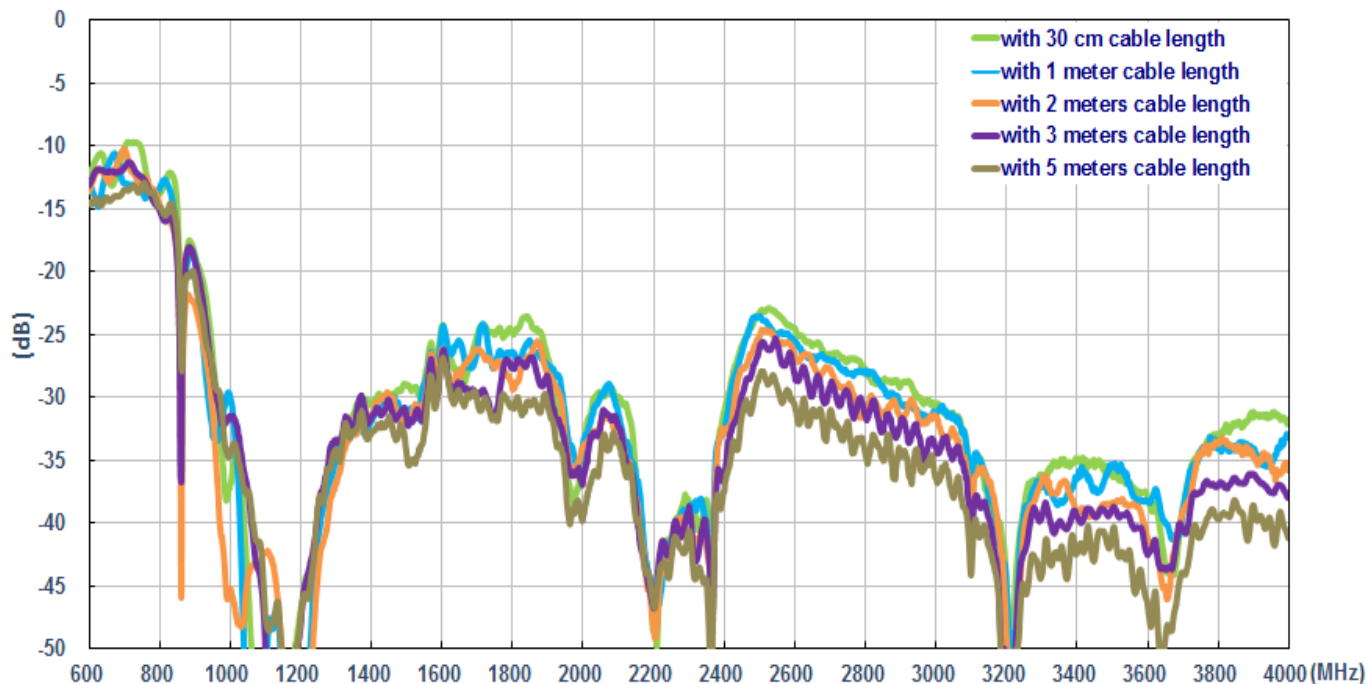

6.2.4. Efficiency (ANTENNA_1 on the 2mm ABS)

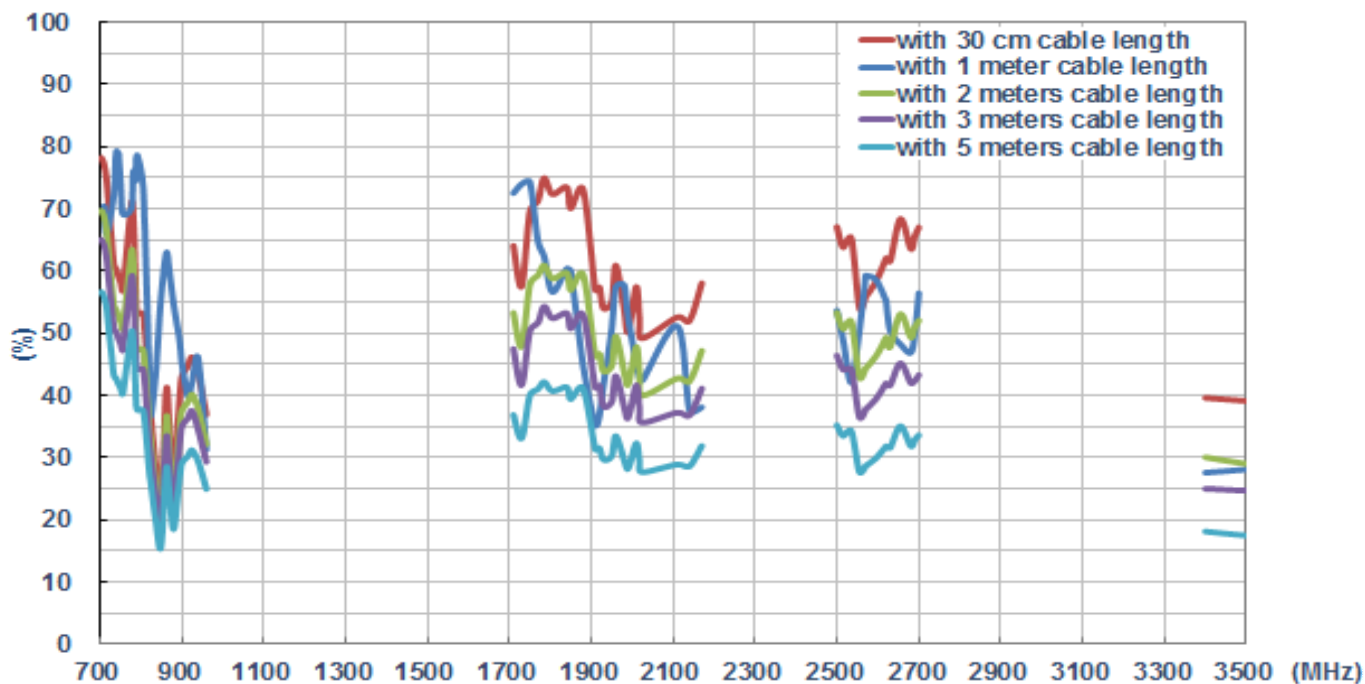

6.2.5. Efficiency (ANTENNA_2 on the 2mm ABS)

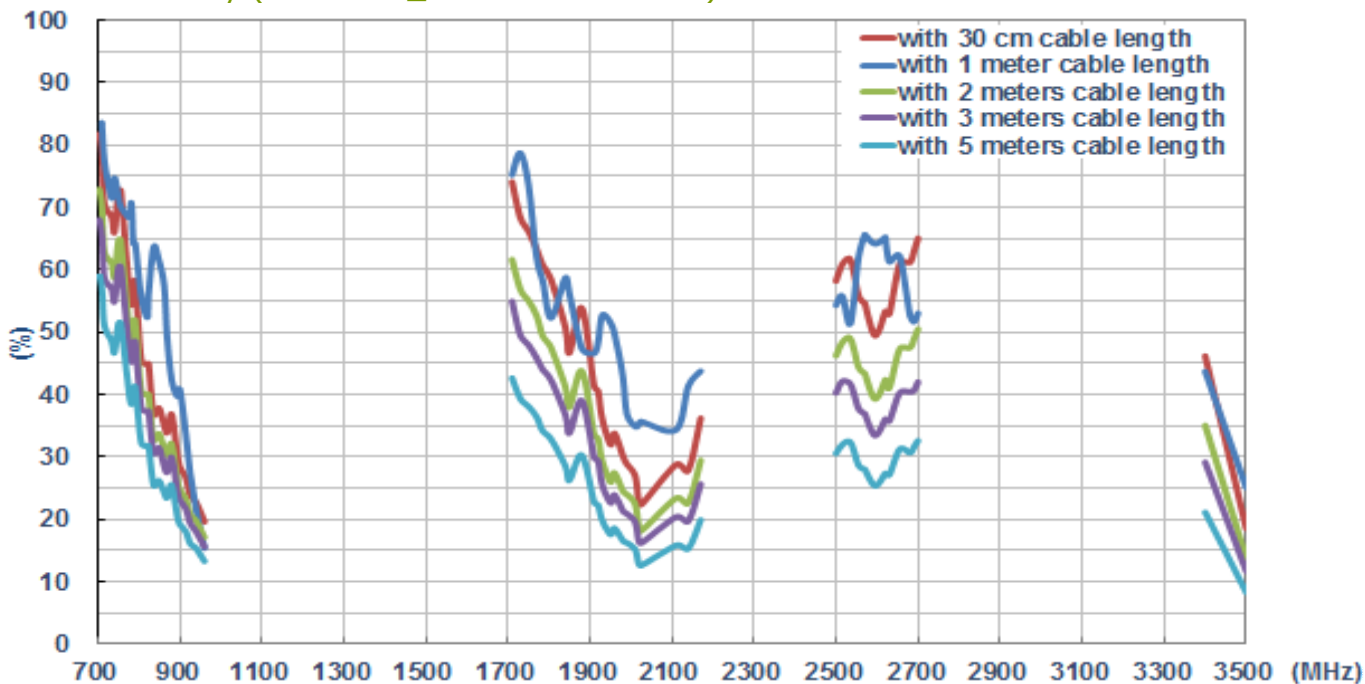

6.2.6. Average Gain (ANTENNA_1 on the 2mm ABS)

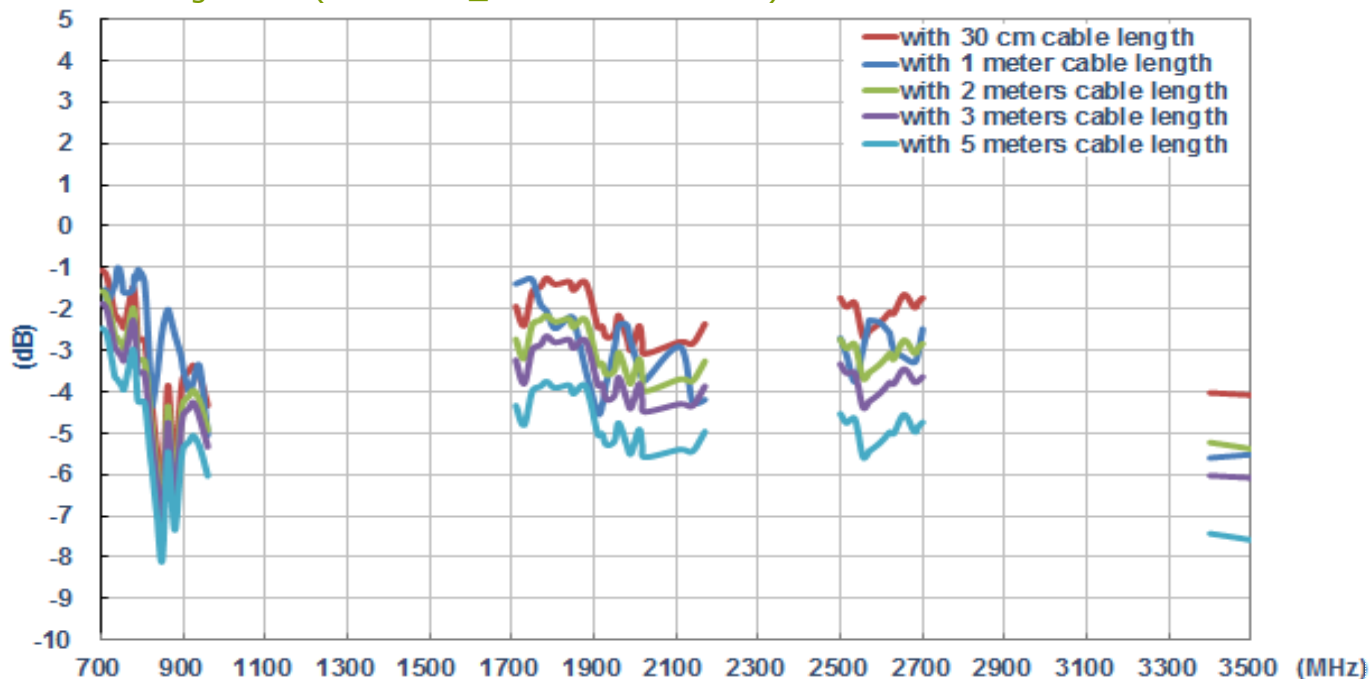

6.2.7. Average Gain (ANTENNA_2 on the 2mm ABS)

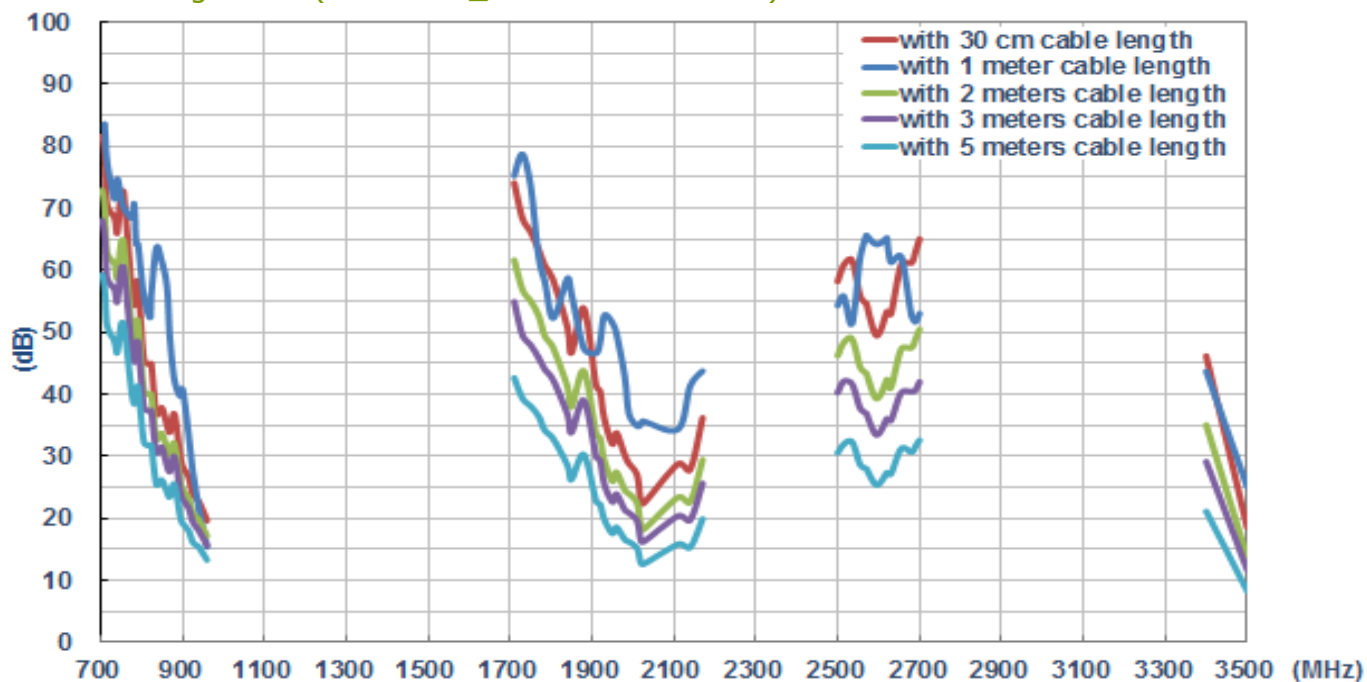

6.2.8. Peak Gain (ANTENNA_1 on the 2mm ABS)

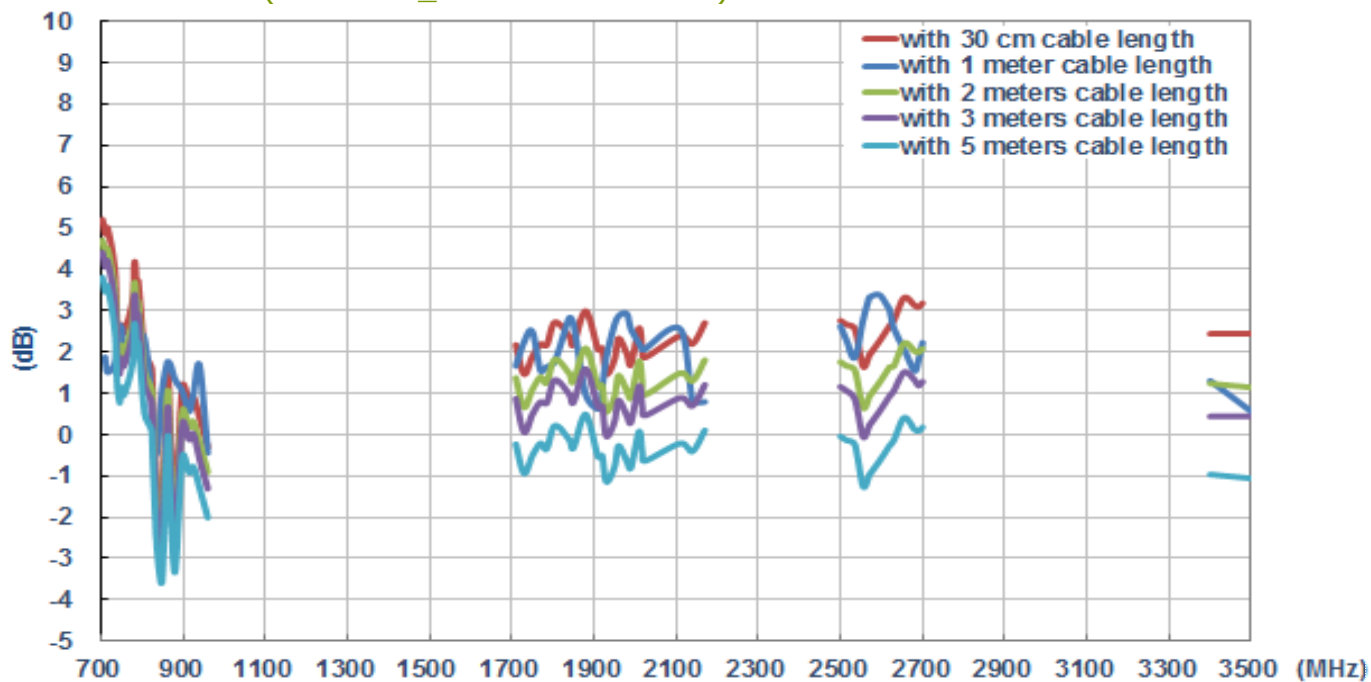

6.2.9. Peak Gain (ANTENNA_2 on the 2mm ABS)

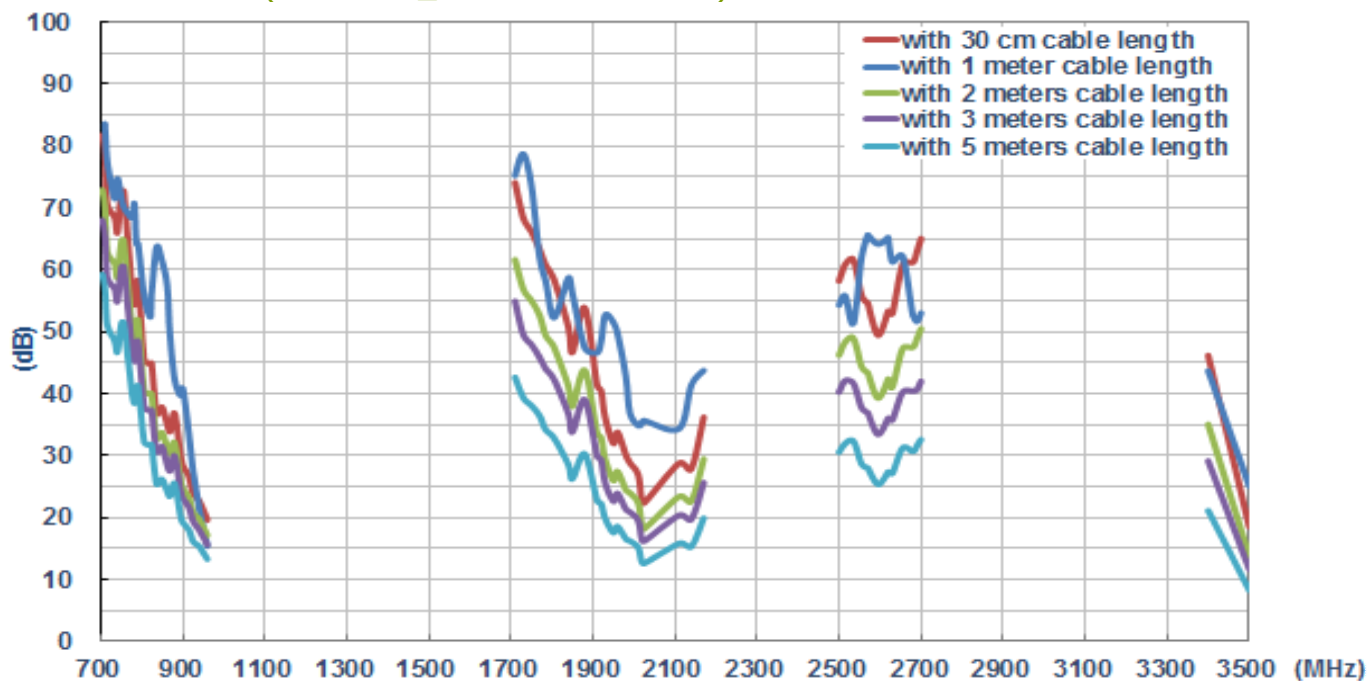

6.3. On the glass base

6.3.1. Return loss (ANTENNA_1 on the glass)

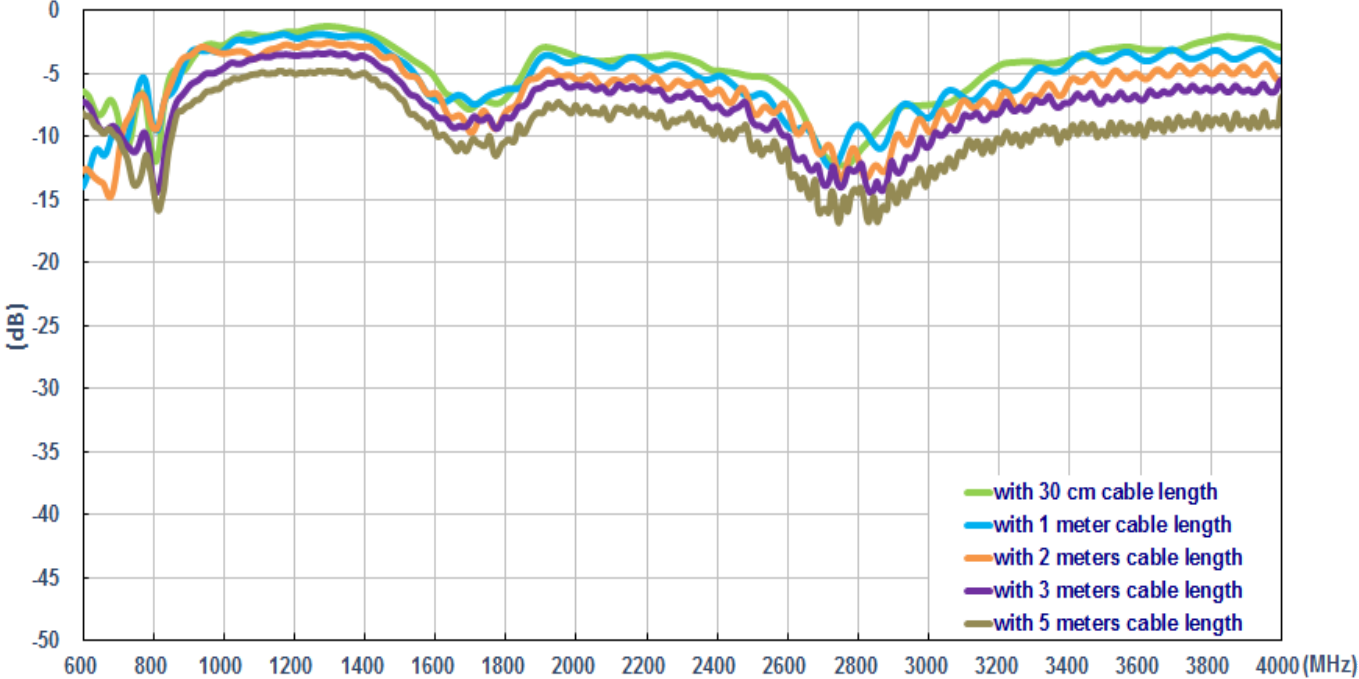

6.3.2. Return loss (ANTENNA_2 on the glass)

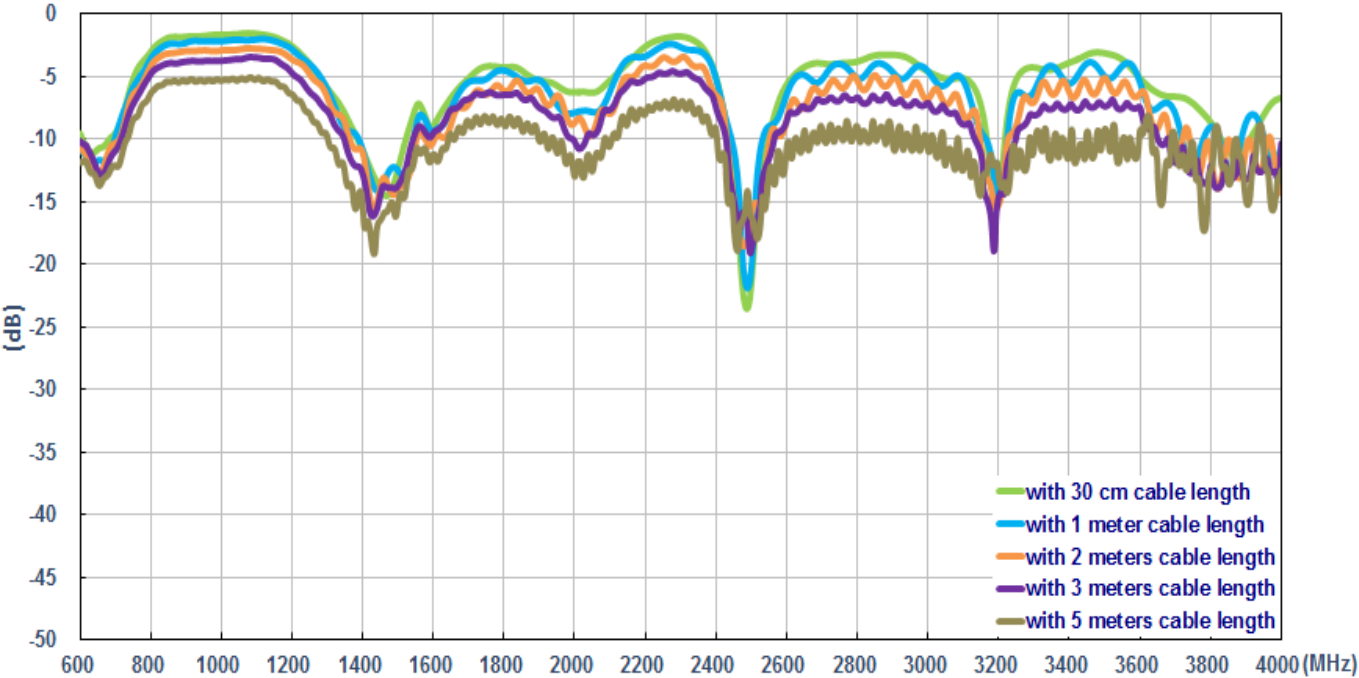

6.3.3. Insertion loss (on the glass)

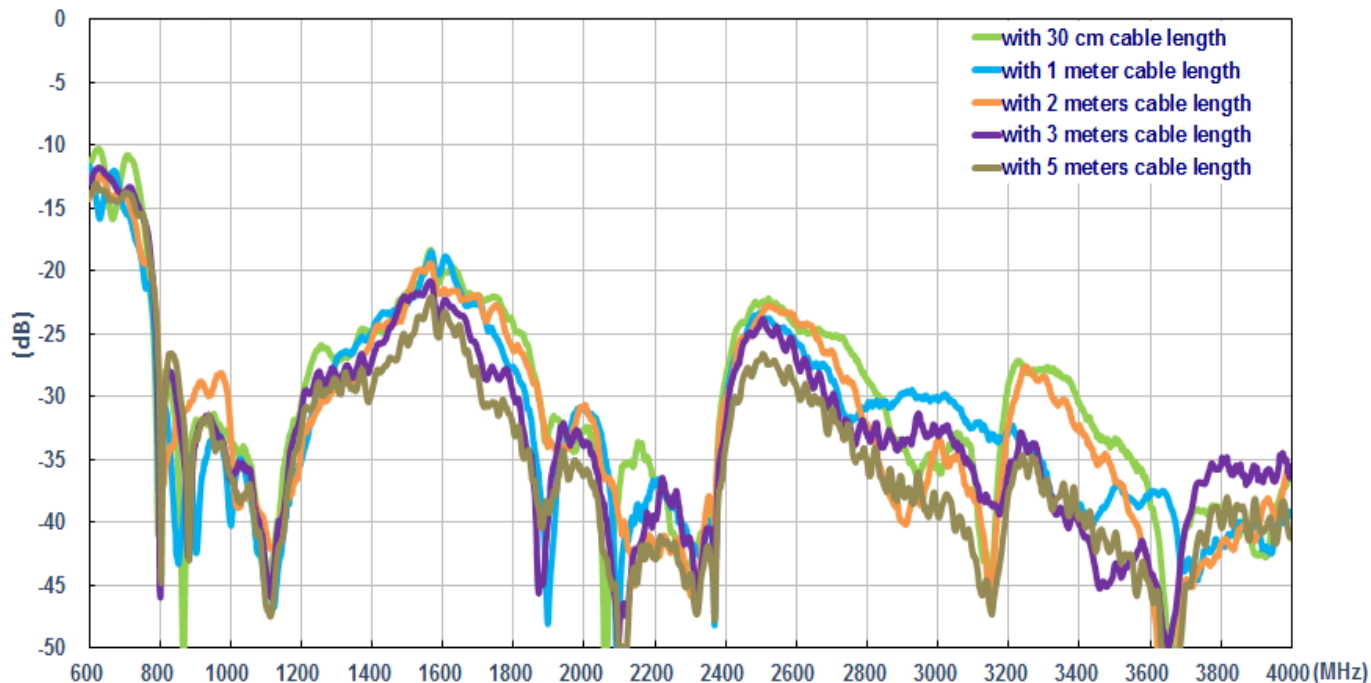

6.3.4. Efficiency (ANTENNA_1 on the glass)

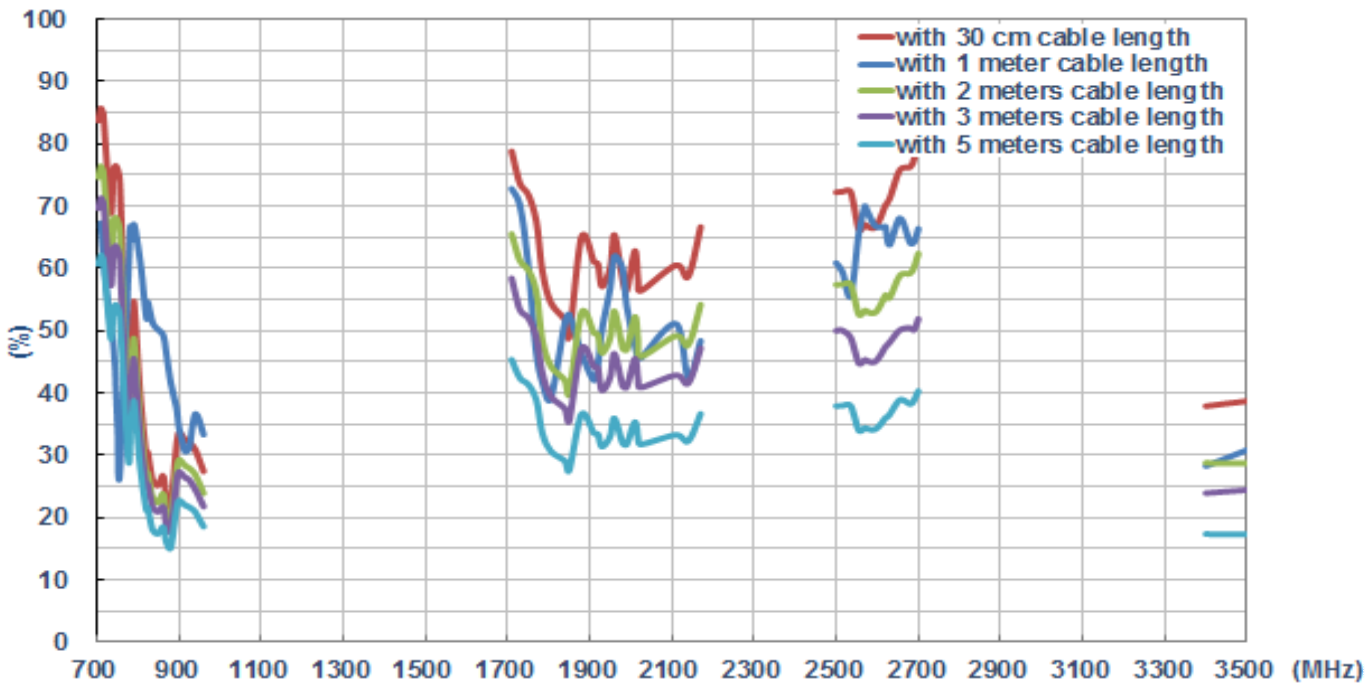

6.3.5. Efficiency (ANTENNA_2 in on the glass)

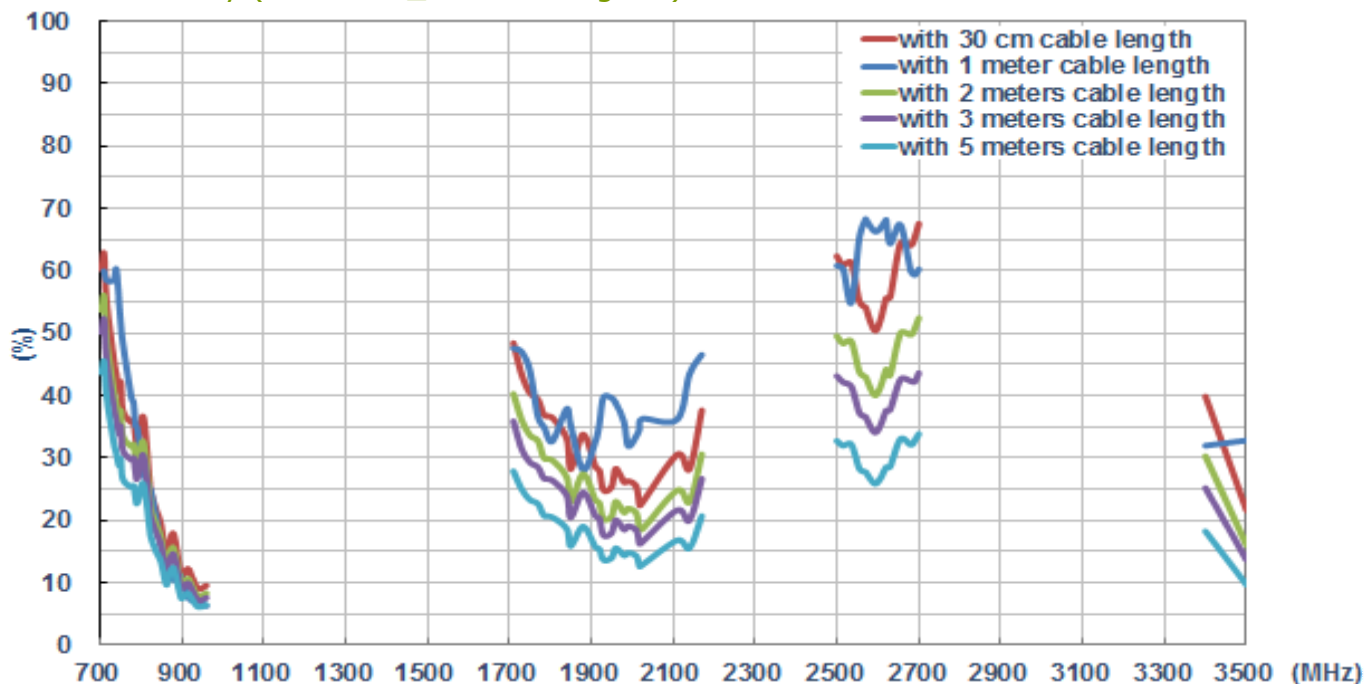

6.3.6. Average Gain (ANTENNA_1 on the glass)

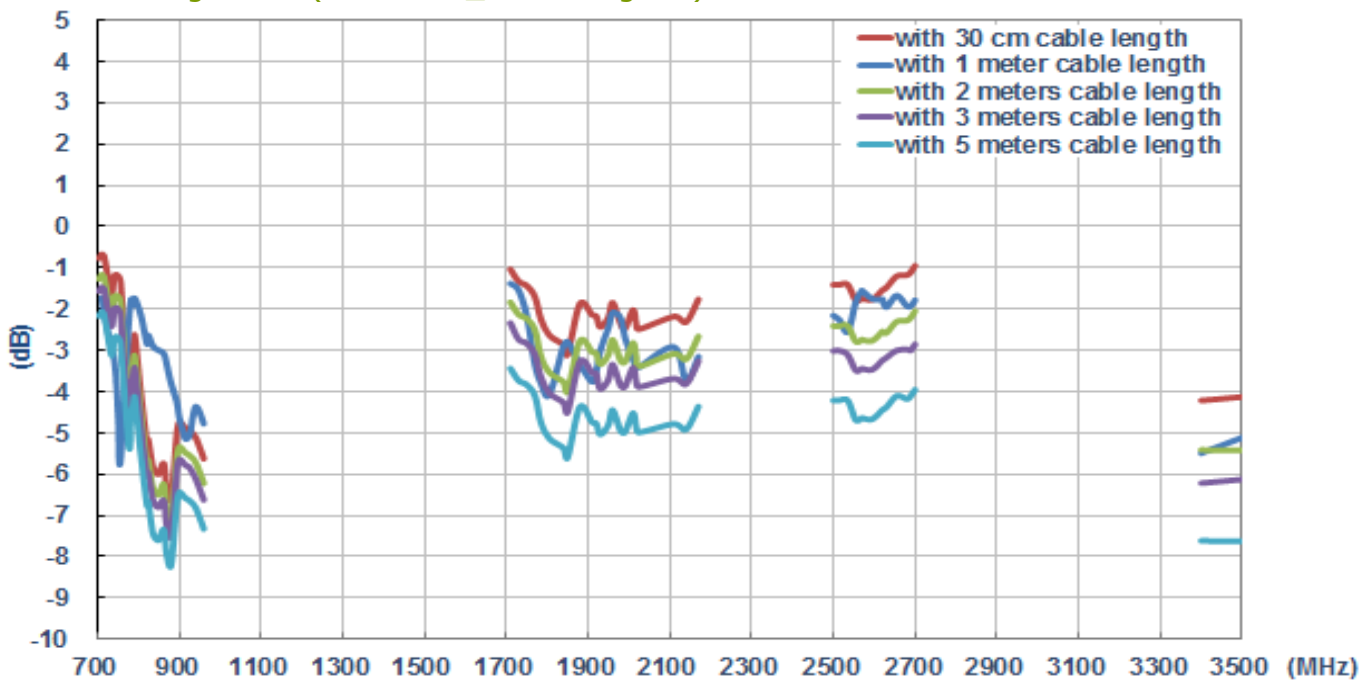

6.3.7. Average Gain (ANTENNA_2 on the glass)

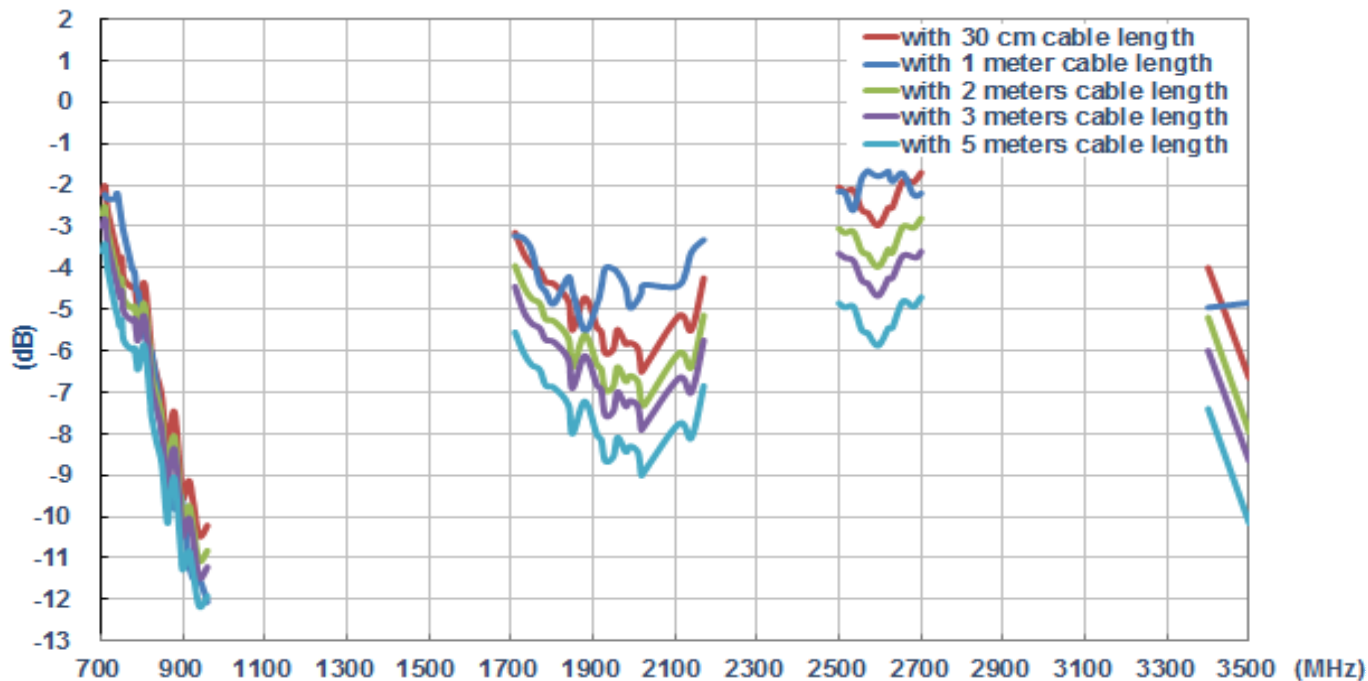

6.3.8. Peak Gain (ANTENNA_1 on the glass)

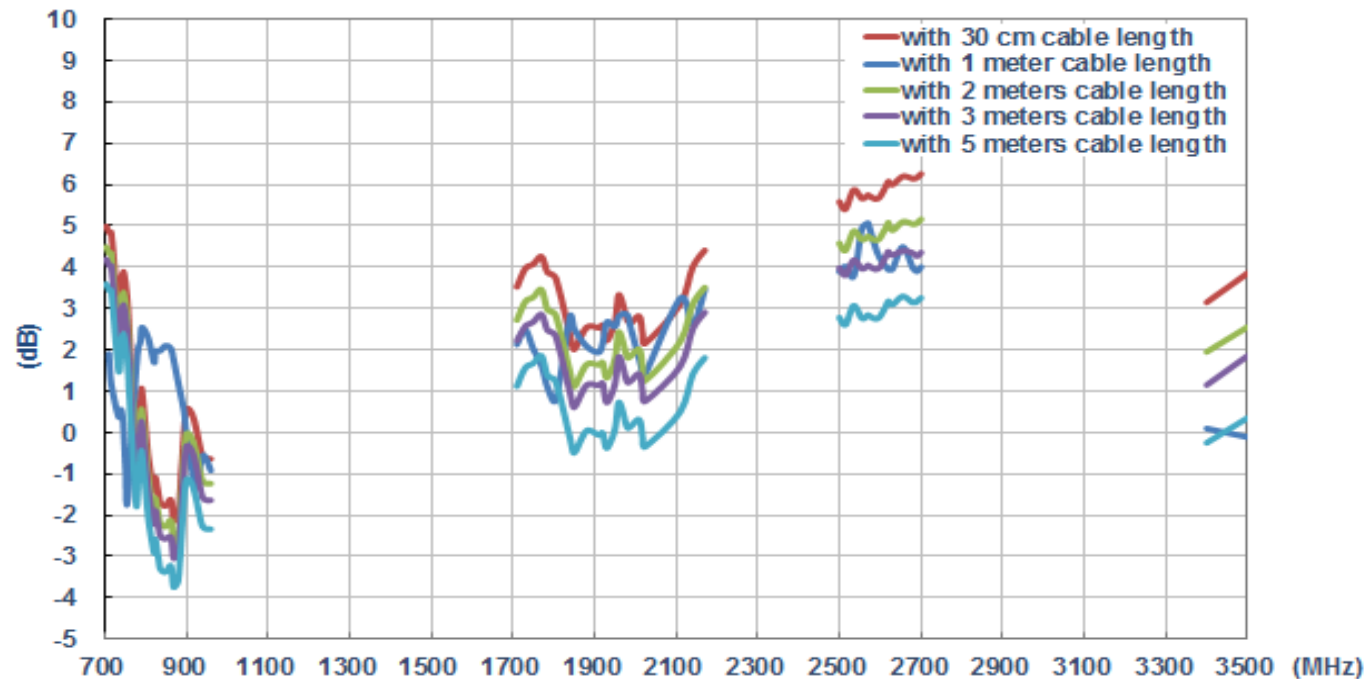

6.3.9. Peak Gain (ANTENNA_2 on the glass)

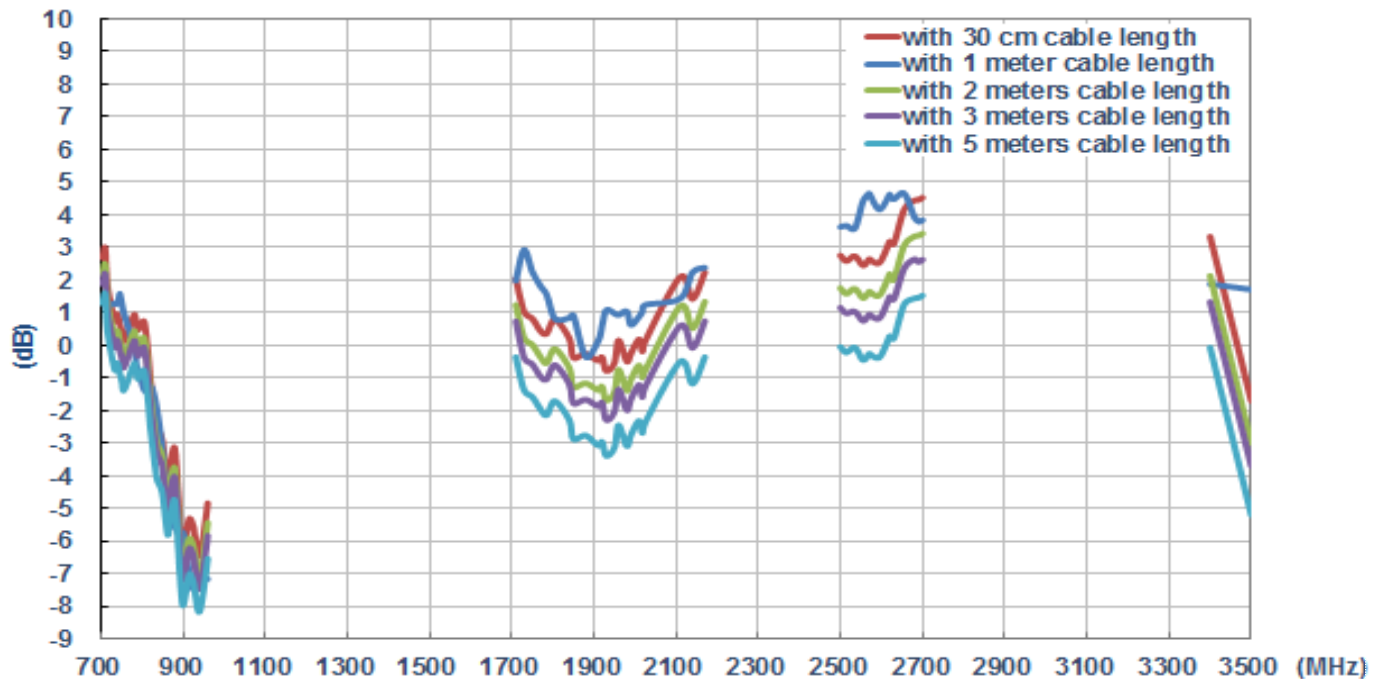

Taoglas makes no warranties based on the accuracy or completeness of the contents of this document and reserves the right to make changes to specifications and product descriptions at any time without notice. Taoglas reserves all rights to this document and the information contained herein.

Reproduction, use or disclosure to third parties without express permission is strictly prohibited.

Copyright © Taoglas Ltd.