

## Technical Data Sheet

### Top View LEDs

#### 45-21/G6C-AM2P2B/2T

#### Features

- P-LCC-2 package.
- White package.
- Optical indicator
- Colorless clear window
- Wide viewing angle.
- Suitable for vapor-phase reflow, infrared reflow and wave solder processes
- Computable with automatic placement equipment
- Available on tape and reel(8mm Tape)
- Pb-free.
- The product itself will remain within RoHS compliant version.



#### Descriptions

- The 45-21 series available in soft orange, green, blue and yellow. Due to the package design, the LED has wide viewing angle and optimized light coupling by inter reflector. This feature makes the device ideal for light pipe application. The low current requirement makes this device ideal for portable equipment or any other application where power is at premium.

#### Applications

- Telecommunication: indicator and backlighting in telephone and fax
- Flat backlight for LCD, switch and symbol
- Light pipe application
- General use

#### Device Selection Guide

Chip	Emitted Color	Resin Color
Material		
AlGaInP	Green	Water Clear

Technical Data Sheet

Top View LEDs

45-21/G6C-AM2P2B/2T

Package Outline Dimensions

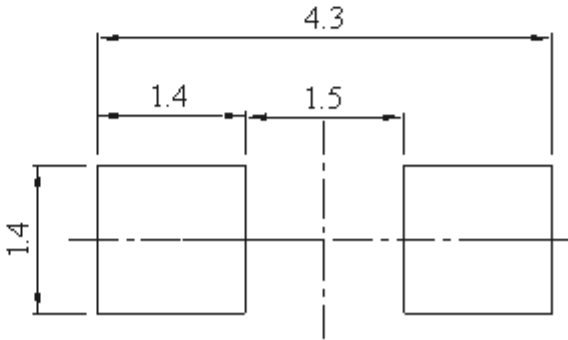
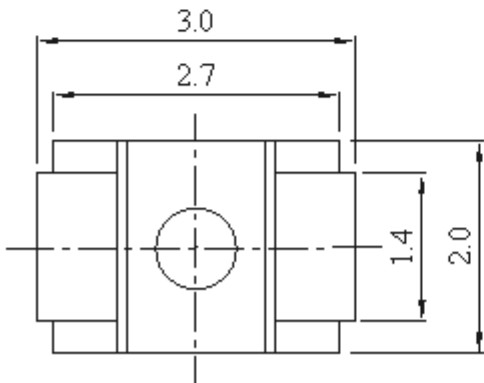
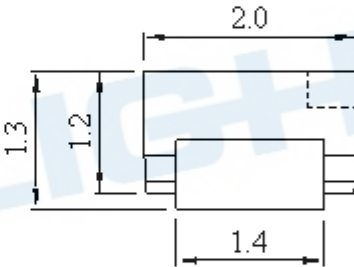
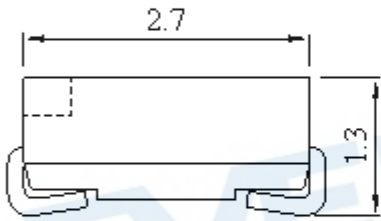
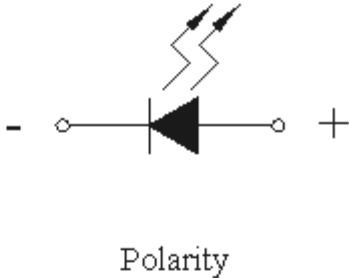
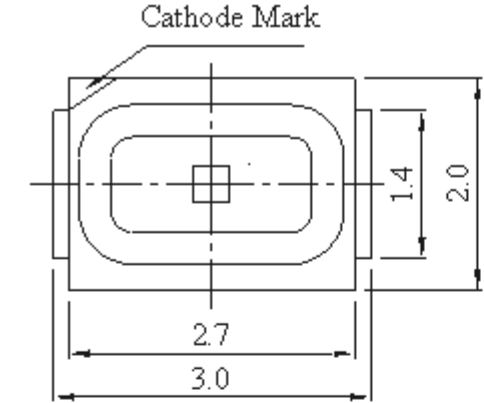

Recommended soldering pad design

Note: Tolerances unless mentioned is  $\pm 0.1$ mm; Unit = mm.

# Technical Data Sheet

## Top View LEDs

### 45-21/G6C-AM2P2B/2T

#### Absolute Maximum Ratings (Ta=25°C)

Parameter	Symbol	Rating	Unit
Reverse Voltage	V <sub>R</sub>	5	V
Forward Current	I <sub>F</sub>	25	mA
Peak Forward Current (Duty 1/10 @1KHz)	I <sub>FP</sub>	60	mA
Power Dissipation	P <sub>d</sub>	60	mW
Electrostatic Discharge(HBM)	ESD	2000	V
Operating Temperature	T <sub>opr</sub>	-40 ~ +85	°C
Storage Temperature	T <sub>stg</sub>	-40 ~ +90	°C
Soldering Temperature	T <sub>sol</sub>	Reflow Soldering: 260 °C for 10 sec. Hand Soldering : 350 °C for 3 sec.	

#### Electro-Optical Characteristics (Ta=25°C)

Parameter	Symbol	Min.	Typ.	Max.	Unit	Condition
Luminous Intensity	I <sub>v</sub>	22.5	----	72	mcd	I <sub>F</sub> =20mA
Viewing Angle	2θ <sub>1/2</sub>	---	120	---	deg	
Peak Wavelength	λ <sub>p</sub>	---	575	---	nm	
Dominant Wavelength	λ <sub>d</sub>	569.5	---	577.5	nm	
Spectrum Radiation Bandwidth	Δλ	----	20	----	nm	
Forward Voltage	V <sub>F</sub>	1.75	----	2.35	V	
Reverse Current	I <sub>R</sub>	----	----	10	μA	V <sub>R</sub> =5V

#### Notes:

1. Tolerance of Luminous Intensity: ±11%
2. Tolerance of Dominant Wavelength: ±1nm
3. Tolerance of Forward Voltage: ±0.1V

## Technical Data Sheet

### Top View LEDs

#### 45-21/G6C-AM2P2B/2T

#### Bin Range of Luminous Intensity

Bin Code	Min.	Max.	Unit	Conduction
M2	22.5	28.5	mcd	I <sub>F</sub> =20mA
N1	28.5	36.0		
N2	36.5	45.0		
P1	45.0	57.0		
P2	57.0	72.0		

#### Bin Range of Dominant Wavelength

Group	Bin Code	Min.	Max.	Unit	Condition
A	C16	569.5	571.5	nm	I <sub>F</sub> =20mA
	C17	571.5	573.5		
	C18	573.5	575.5		
	C19	575.5	577.5		

#### Bin Range of Forward Voltage

Group	Bin Code	Min.	Max.	Unit	Condition
B	0	1.75	1.95	V	I <sub>F</sub> =20mA
	1	1.95	2.15		
	2	2.15	2.35		

#### Note:

1. Tolerance of Luminous Intensity: ±11%
2. Tolerance of Dominant Wavelength: ±1nm
3. Tolerance of Forward Voltage: ±0.1V

## Technical Data Sheet

### Top View LEDs

### 45-21/G6C-AM2P2B/2T

#### Typical Electro-Optical Characteristics Curves

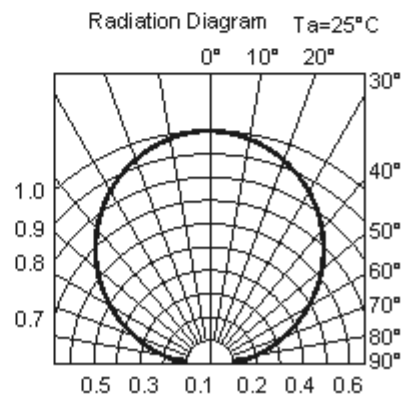
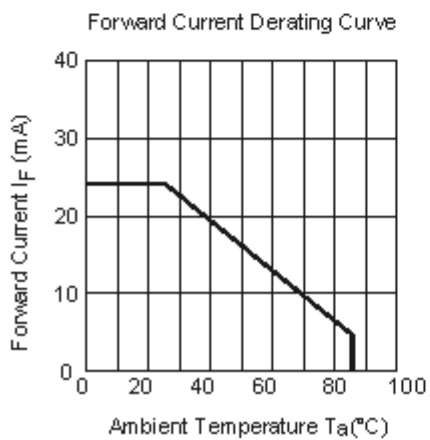
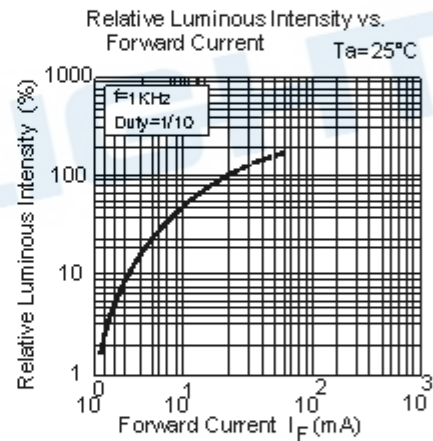
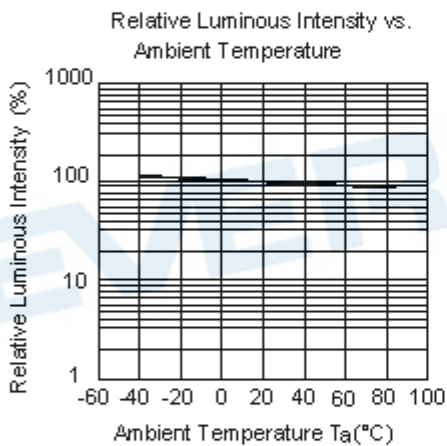
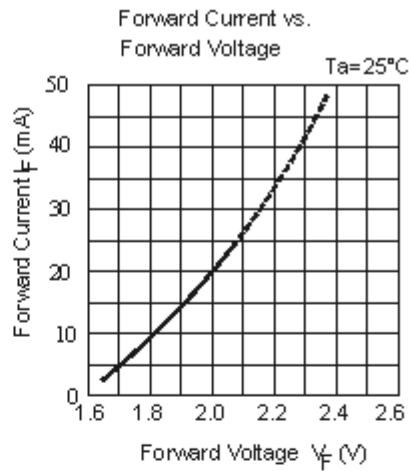
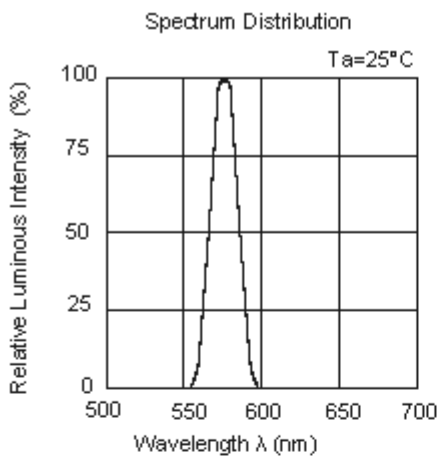

## Technical Data Sheet

### Top View LEDs

**45-21/G6C-AM2P2B/2T**

#### Label Explanation

CAT: Luminous Intensity Rank

HUE: Dom.Wavelength Rank

REF: Forward Voltage Rank



#### Reel Dimensions

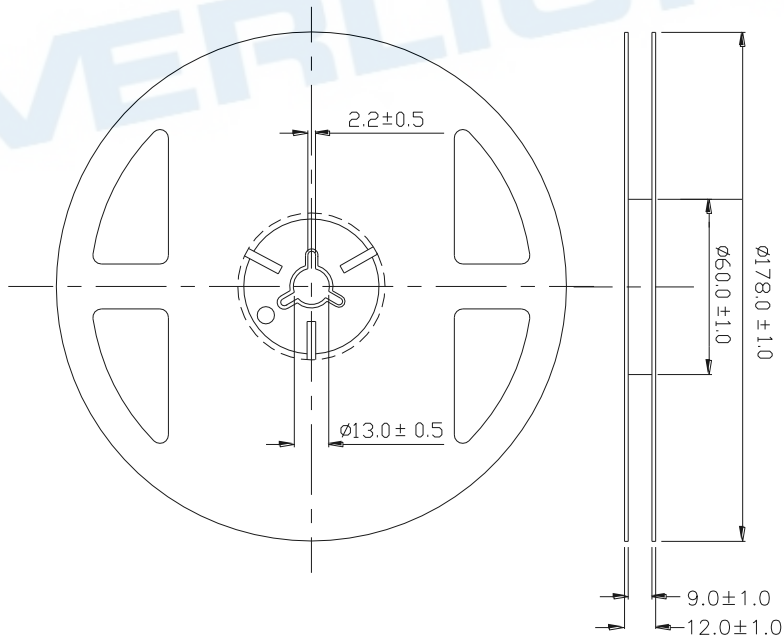

**Note:** Tolerance unless mentioned is  $\pm 0.1$ mm; Unit = mm

## Technical Data Sheet

### Top View LEDs

#### 45-21/G6C-AM2P2B/2T

Carrier Tape Dimensions: Loaded Quantity 2000 pcs Per Reel

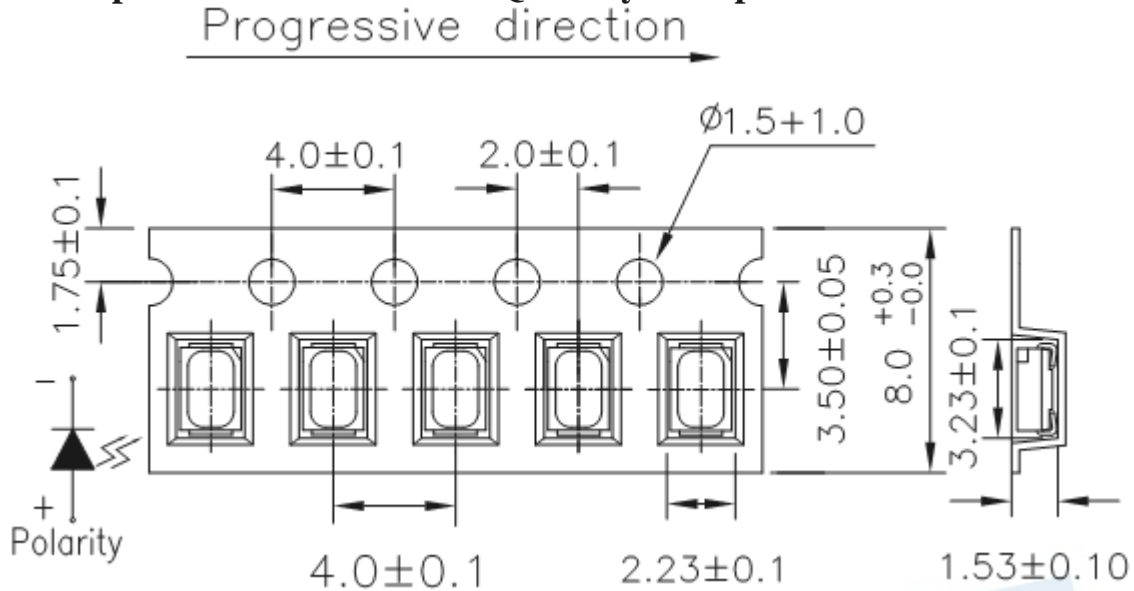

**Note:** Tolerance unless mentioned is  $\pm 0.1$  mm; Unit = mm

### Moisture Resistant Packaging

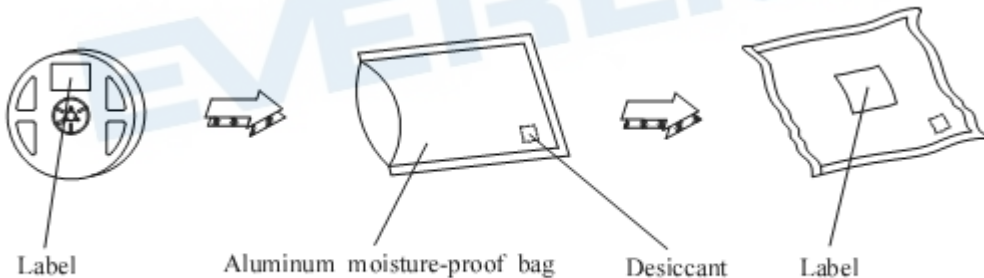

# Technical Data Sheet

## Top View LEDs

### 45-21/G6C-AM2P2B/2T

#### Reliability Test Items and Conditions

The reliability of products shall be satisfied with items listed below.

Confidence level : 90%

LTPD : 10%

No.	Items	Test Condition	Test Hours/Cycles	Sample Size	Ac/Re
1	Reflow Soldering	Temp. : 260°C±5°C Min. 10 sec.	6 Min.	22 PCS	0/1
2	Temperature Cycle	H : +100°C 15min ↓ 5 min L : -40°C 15min	300 Cycles	22 PCS.	0/1
3	Thermal Shock	H : +100°C 5min ↓ 10 sec L : -10°C 5min	300 Cycles	22 PCS.	0/1
4	High Temperature Storage	Temp. : 100°C	1000 Hrs.	22 PCS.	0/1
5	Low Temperature Storage	Temp. : -40°C	1000 Hrs.	22 PCS.	0/1
6	DC Operating Life	I <sub>F</sub> = 20 mA	1000 Hrs.	22 PCS.	0/1
7	High Temperature / High Humidity	85°C/85%RH	1000 Hrs.	22 PCS.	0/1



## Technical Data Sheet

### Top View LEDs

**45-21/G6C-AM2P2B/2T**

#### Precautions for Use

##### 1. Over-current-proof

Customer must apply resistors for protection; otherwise slight voltage shift will cause big current change (Burn out will happen).

##### 2. Storage

2.1 Do not open moisture proof bag before the products are ready to use.

2.2 Before opening the package: The LEDs should be used within one year and kept at 30°C or less and 70%RH or less.

2.3 After opening the package: We recommend that the LED should be soldered quickly (within 3 days).The soldering condition is 30°C or less and 60% RH or less. If unused LEDs remain, it should be stored in moisture proof packages.

2.4 If the moisture absorbent material (silica gel) has faded away or the LEDs have exceeded the storage time, baking treatment should be performed using the following conditions.

Baking treatment: 60±5°C for 24 hours.(One time only)

##### 3. Soldering Condition

###### 3.1 Pb-free solder temperature profile

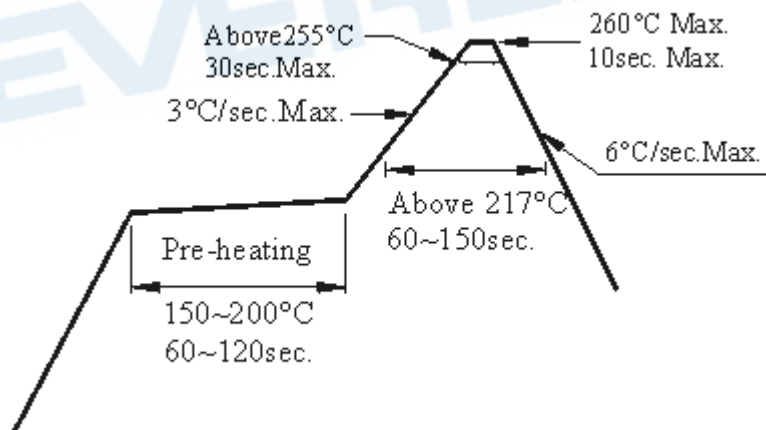

3.2 Reflow soldering should not be done more than two times.

3.3 When soldering, do not put stress on the LEDs during heating.

3.4 After soldering, do not warp the circuit board.

## Technical Data Sheet

### Top View LEDs

#### 45-21/G6C-AM2P2B/2T

#### 4. Soldering Iron

Each terminal is to go to the tip of soldering iron temperature less than 350°C for 3 seconds within once in less than the soldering iron capacity 25W. Leave two seconds and more intervals, and do soldering of each terminal. Be careful because the damage of the product is often started at the time of the hand solder.

#### 5. Repairing

Repair should not be done after the LEDs have been soldered. When repairing is unavoidable, a double-head soldering iron should be used (as below figure). It should be confirmed beforehand whether the characteristics of the LEDs will or will not be damaged by repairing.

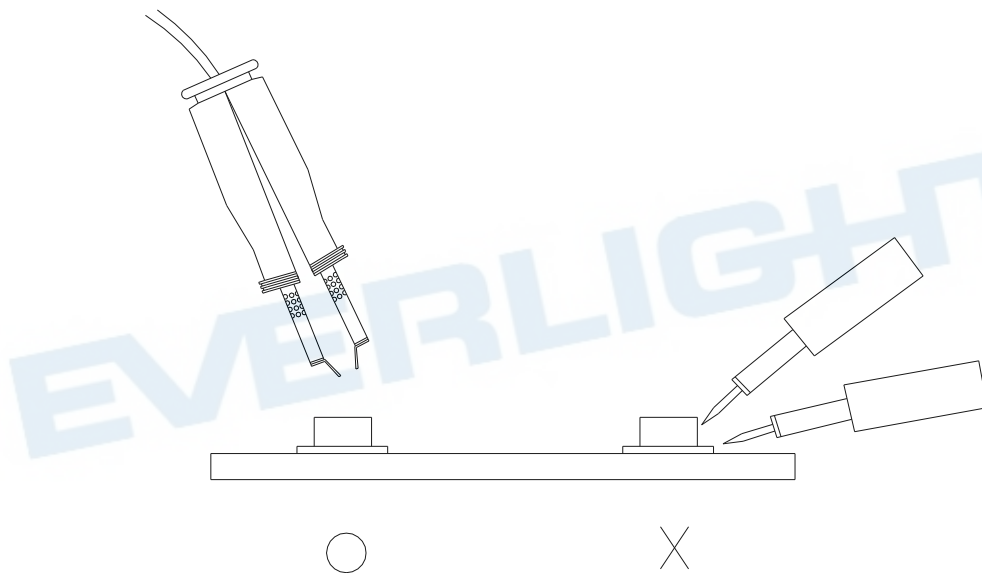

**EVERLIGHT ELECTRONICS CO., LTD.**  
Office: No 25, Lane 76, Sec 3, Chung Yang Rd,  
Tucheng, Taipei 236, Taiwan, R.O.C

Tel: 886-2-2267-2000, 2267-9936  
Fax: 886-2267-6244, 2267-6189, 2267-6306  
<http://www.everlight.com>