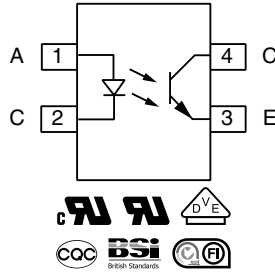
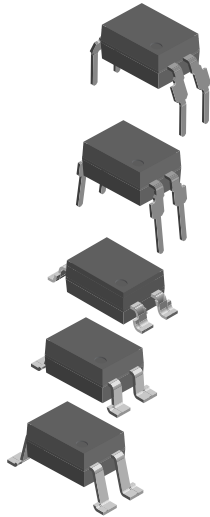


# Optocoupler, Phototransistor Output, High Reliability, 5300 V<sub>RMS</sub>, Low Input Current



## DESCRIPTION

The 110 °C rated VO618A feature a high current transfer ratio, low coupling capacitance and high isolation voltage. These couplers have a GaAs infrared diode emitter, which is optically coupled to a silicon planar phototransistor detector, and is incorporated in a plastic DIP-4 package.

The coupling devices are designed for signal transmission between two electrically separated circuits.

The couplers are end-stackable with 2.54 mm spacing.

Creepage and clearance distances of > 8.0 mm are achieved with option 6 and 8. This version complies with IEC 60950 (DIN VDE 0805) for reinforced insulation up to an operation voltage of 400 V<sub>RMS</sub> or DC. Specifications subject to change.

## FEATURES

- Operating temperature from -55 °C to +110 °C
- Good CTR linearity depending on forward current
- Isolation test voltage, 5300 V<sub>RMS</sub>
- High collector emitter voltage, V<sub>CEO</sub> = 80 V
- Low saturation voltage
- Fast switching times
- Low CTR degradation
- Temperature stable
- Low coupling capacitance
- End stackable, 0.100" (2.54 mm) spacing
- High common mode interference immunity
- Material categorization: for definitions of compliance please see [www.vishay.com/doc?99912](http://www.vishay.com/doc?99912)



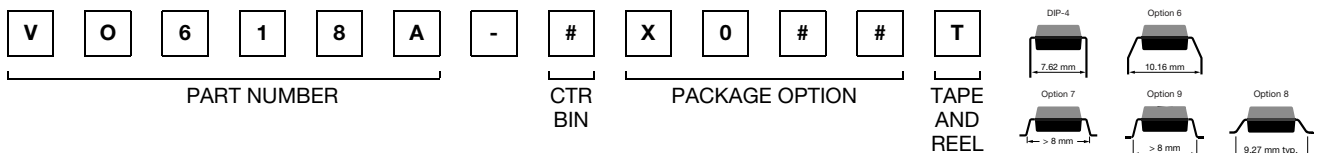
## APPLICATIONS

- AC adapters
- SMPS
- PLC
- Factory automation
- Game consoles

## AGENCY APPROVALS

- UL1577, file no. E52744
- cUL tested to CSA 22.2 bulletin 5A
- DIN EN 60747-5-5 (VDE 0884-5), available with option 1
- BSI IEC 60950; IEC 60065
- FIMKO EN 60065, EN 60950-1
- CQC GB8898-2001

## ORDERING INFORMATION



AGENCY CERTIFIED/PACKAGE	CTR (%)			
	1 mA			
<b>UL, cUL, BSI, FIMKO</b>	<b>50 to 600</b>	<b>63 to 125</b>	<b>100 to 200</b>	<b>160 to 320</b>
DIP-4	VO618A	VO618A-2	VO618A-3	VO618A-4
SMD-4, option 9	-	VO618A-2X009T	-	-
<b>VDE, UL, cUL, BSI, FIMKO</b>	<b>50 to 600</b>	<b>63 to 125</b>	<b>100 to 200</b>	<b>160 to 320</b>
DIP-4, 400 mil, option 6	-	-	-	VO618A-4X016
SMD-4, option 7	-	VO618A-2X017T	VO618A-3X017T	VO618A-4X017T
SMD-4, option 8	-	-	VO618A-3X018T	-

### Note

- Additional options may be possible, please contact sales office.

<b>ABSOLUTE MAXIMUM RATINGS</b> ( $T_{amb} = 25\text{ }^{\circ}\text{C}$ , unless otherwise specified)				
PARAMETER	TEST CONDITION	SYMBOL	VALUE	UNIT
<b>INPUT</b>				
Reverse voltage		$V_R$	6	V
Forward current		$I_F$	60	mA
Forward surge current	$t_p \leq 10\text{ }\mu\text{s}$	$I_{FSM}$	1.5	A
LED power dissipation	at $25\text{ }^{\circ}\text{C}$	$P_{diss}$	70	mW
<b>OUTPUT</b>				
Collector emitter voltage		$V_{CEO}$	80	V
Emitter collector voltage		$V_{ECO}$	7	V
Collector current		$I_C$	50	mA
Collector peak current	$t_p/T = 0.5, t_p \leq 10\text{ ms}$	$I_{CM}$	100	mA
Output power dissipation	at $25\text{ }^{\circ}\text{C}$	$P_{diss}$	150	mW
<b>COUPLER</b>				
Isolation test voltage (RMS)	$t = 1\text{ min}$	$V_{ISO}$	5300	$V_{RMS}$
Total power dissipation		$P_{tot}$	200	mW
Operation temperature		$T_{amb}$	-55 to +110	$^{\circ}\text{C}$
Storage temperature range		$T_{stg}$	-55 to +150	$^{\circ}\text{C}$
Soldering temperature	2 mm from case, $\leq 10\text{ s}$	$T_{sld}$	260	$^{\circ}\text{C}$

**Note**

- Stresses in excess of the absolute maximum ratings can cause permanent damage to the device. Functional operation of the device is not implied at these or any other conditions in excess of those given in the operational sections of this document. Exposure to absolute maximum ratings for extended periods of the time can adversely affect reliability.

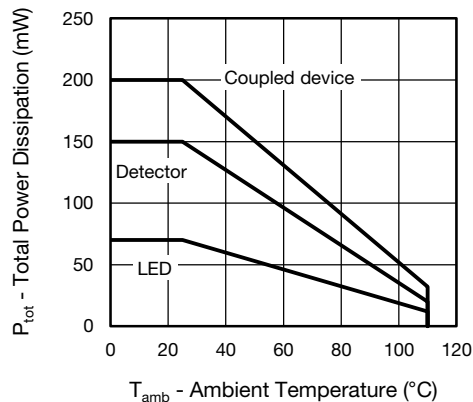


Fig. 1 - Total Power Dissipation vs. Ambient Temperature



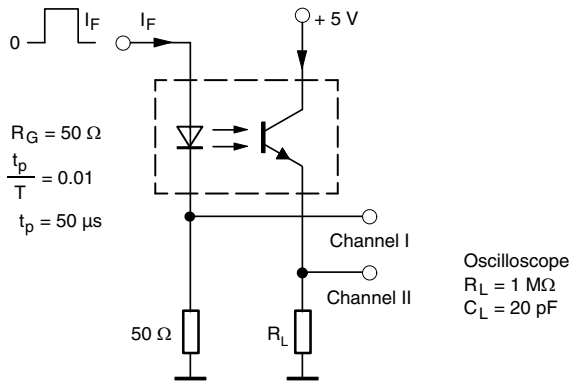
ELECTRICAL CHARACTERISTICS ( $T_{amb} = 25\text{ }^{\circ}\text{C}$ , unless otherwise specified)						
PARAMETER	TEST CONDITION	SYMBOL	MIN.	TYP.	MAX.	UNIT
<b>INPUT</b>						
Forward voltage	$I_F = 5\text{ mA}$	$V_F$	1	1.1	1.65	V
Reverse current	$V_R = 6\text{ V}$	$I_R$		0.01	10	$\mu\text{A}$
Junction capacitance	$V_R = 0\text{ V}$ , $f = 1\text{ MHz}$	$C_j$		13		pF
<b>OUTPUT</b>						
Collector emitter leakage current	$V_{CE} = 10\text{ V}$	$I_{CEO}$		10	200	nA
Collector emitter capacitance	$V_{CE} = 5\text{ V}$ , $f = 1\text{ MHz}$	$C_{CE}$		5.2		pF
Collector emitter breakdown voltage	$I_C = 1\text{ mA}$	$BV_{CEO}$	80			V
Emitter collector breakdown voltage	$I_E = 100\text{ }\mu\text{A}$	$BV_{ECO}$	7			V
<b>COUPLER</b>						
Collector emitter saturation voltage	$I_F = 1\text{ mA}$ , $I_C = 2.5\text{ mA}$	$V_{CEsat}$		0.25	0.4	V
Coupling capacitance	$f = 1\text{ MHz}$	$C_C$		0.4		pF

**Note**

- Minimum and maximum values are testing requirements. Typical values are characteristics of the device and are the result of engineering evaluation. Typical values are for information only and are not part of the testing requirements.

CURRENT TRANSFER RATIO ( $T_{amb} = 25\text{ }^{\circ}\text{C}$ , unless otherwise specified)							
PARAMETER	TEST CONDITION	PART	SYMBOL	MIN.	TYP.	MAX.	UNIT
$I_C/I_F$	$I_F = 1\text{ mA}$ , $V_{CE} = 5\text{ V}$	VO618A	CTR	50		600	%
		VO618A-2	CTR	63		125	%
		VO618A-3	CTR	100		200	%
		VO618A-4	CTR	160		320	%

SWITCHING CHARACTERISTICS ( $T_{amb} = 25\text{ }^{\circ}\text{C}$ , unless otherwise specified)							
PARAMETER	TEST CONDITION	CTR BIN	SYMBOL	MIN.	TYP.	MAX.	UNIT
<b>NON-SATURATED</b>							
Rise and fall time	$I_F = 1\text{ mA}$ , $V_{CC} = 5\text{ V}$ , $R_L = 75\text{ }\Omega$		$t_r$ , $t_f$		2		$\mu\text{s}$
Turn-on time	$I_F = 1\text{ mA}$ , $V_{CC} = 5\text{ V}$ , $R_L = 75\text{ }\Omega$		$t_{on}$		3		$\mu\text{s}$
Turn-off time			$t_{off}$		2.3		$\mu\text{s}$
Cut-off frequency	$I_F = 1\text{ mA}$ , $V_{CC} = 5\text{ V}$ , $R_L = 75\text{ }\Omega$		$f_{ctr}$		100		kHz
<b>SATURATED</b>							
Turn-on time	$I_F = 1\text{ mA}$		$t_{on}$		4.2		$\mu\text{s}$
Turn-off time	$I_F = 1\text{ mA}$		$t_{off}$		23		$\mu\text{s}$
Rise time	$I_F = 1\text{ mA}$		$t_r$		3		$\mu\text{s}$
Fall time	$I_F = 1\text{ mA}$		$t_f$		14		$\mu\text{s}$

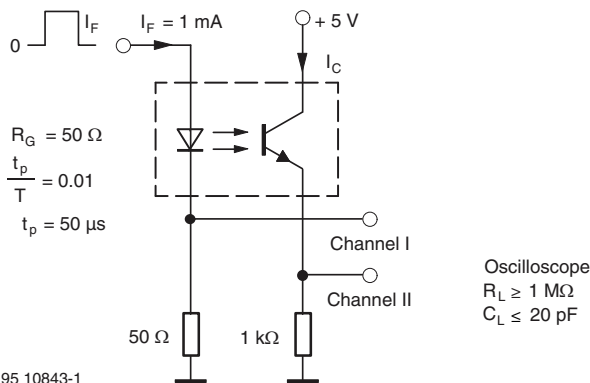


95 10804-3

Fig. 2 - Test Circuit, Non-Saturated Operation



Fig. 4 - Switching Times



95 10843-1

Fig. 3 - Test Circuit, Saturated Operation

SAFETY AND INSULATION RATINGS				
PARAMETER		SYMBOL	VALUE	UNIT
<b>MAXIMUM SAFETY RATINGS</b>				
Output safety power		$P_{SO}$	265	mW
Input safety current		$I_{si}$	130	mA
Safety temperature		$T_S$	150	°C
Comparative tracking index		CTI	175	
<b>INSULATION RATED PARAMETERS</b>				
Maximum withstanding isolation voltage		$V_{ISO}$	5300	$V_{RMS}$
Maximum transient isolation voltage		$V_{IOTM}$	8000	$V_{peak}$
Maximum repetitive peak isolation voltage		$V_{IORM}$	890	$V_{peak}$
Insulation resistance	$T_{amb} = 25\text{ °C}, V_{DC} = 500\text{ V}$	$R_{IO}$	$\geq 10^{12}$	$\Omega$
Insulation resistance	$T_{amb} = 100\text{ °C}, V_{DC} = 500\text{ V}$	$R_{IO}$	$\geq 10^{11}$	$\Omega$
Climatic classification (according to IEC 68 part 1)			55/110/21	
Environment (pollution degree in accordance to DIN VDE 0109)			2	
Internal and external creepage	Standard DIP-4, option 7 and option 9		$\geq 7$	mm
	400 mil DIP-4 and option 8		$\geq 8$	mm
Clearance	Standard DIP-4, option 7 and option 9		$\geq 7$	mm
	400 mil DIP-4 and option 8		$\geq 8$	mm
Insulation thickness		DTI	0.4	mm

**Note**

- As per DIN EN 60747-5-5, § 7.4.3.8.2, this optocoupler is suitable for “safe electrical insulation” only within the safety ratings. Compliance with the safety ratings shall be ensured by means of protective circuits.

**TYPICAL CHARACTERISTICS** ( $T_{amb} = 25\text{ }^{\circ}\text{C}$ , unless otherwise specified)

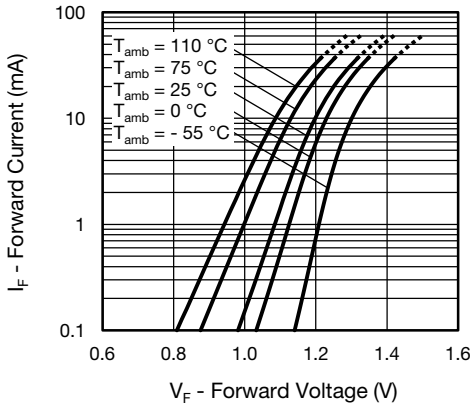


Fig. 5 - Forward Voltage vs. Forward Current

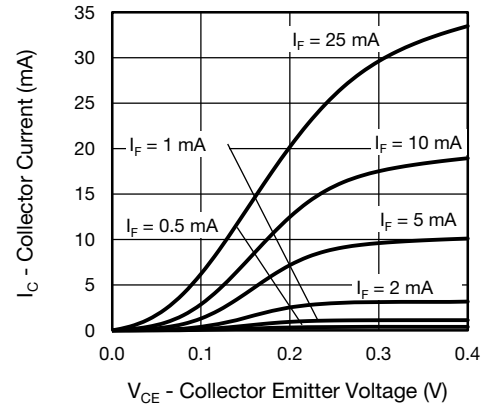


Fig. 8 - Collector Current vs. Collector Emitter Voltage

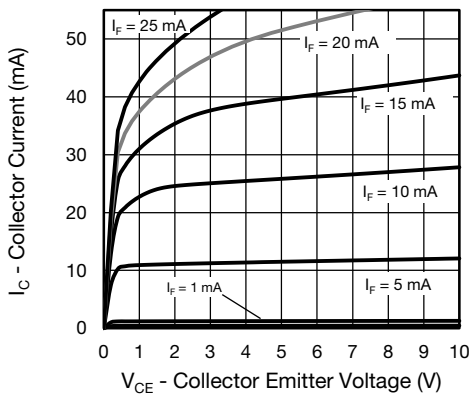


Fig. 6 - Collector Current vs. Collector Emitter Voltage

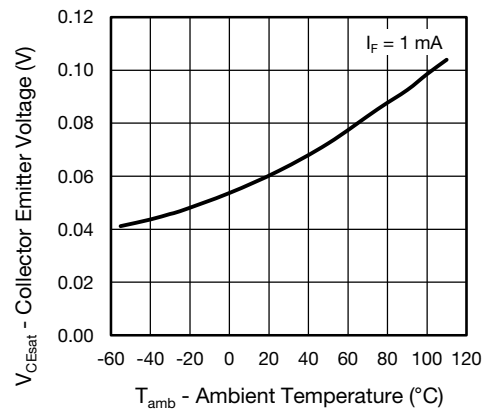


Fig. 9 - Collector Emitter Voltage vs. Ambient Temperature

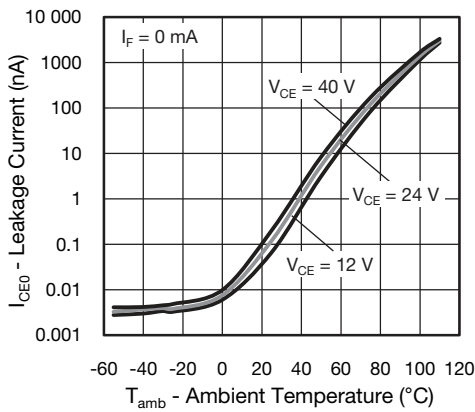


Fig. 7 - Collector Emitter Current vs. Ambient Temperature

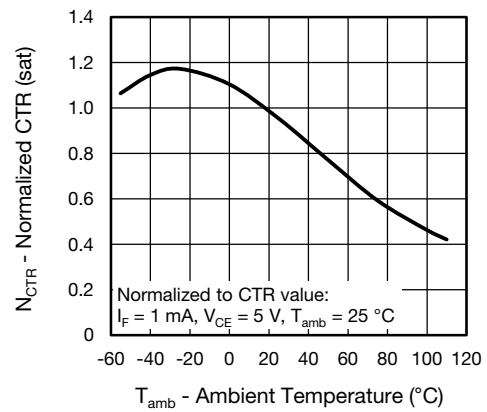


Fig. 10 - Normalized Current Transfer Ratio vs. Ambient Temperature (sat.)

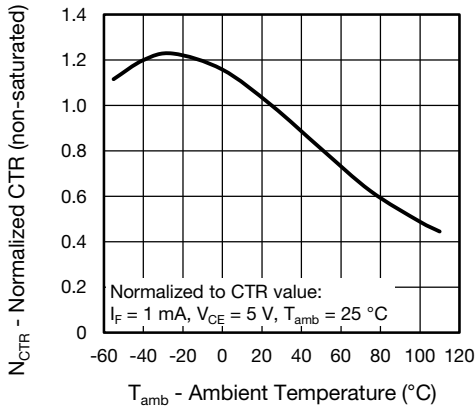


Fig. 11 - Normalized Current Transfer Ratio vs. Ambient Temperature (non-sat.)

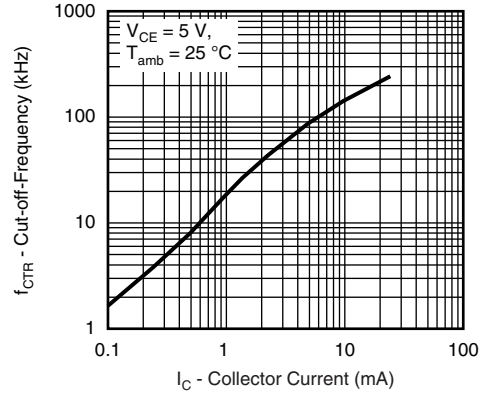


Fig. 14 - Cut-Off Frequency vs. Collector Current

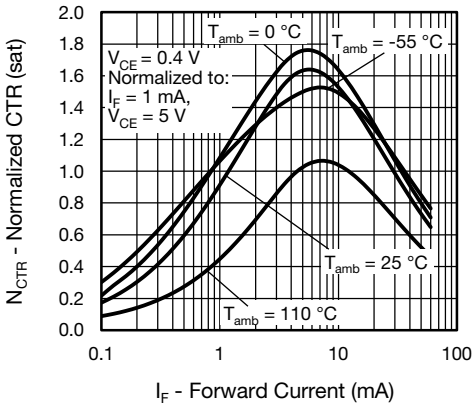


Fig. 12 - Current Transfer Ratio vs. Forward Current (sat.)

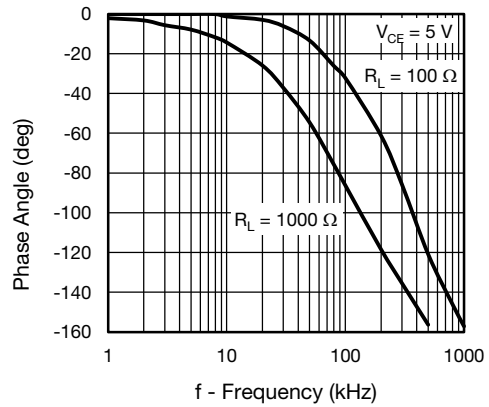


Fig. 15 - Phase Angle vs. Frequency

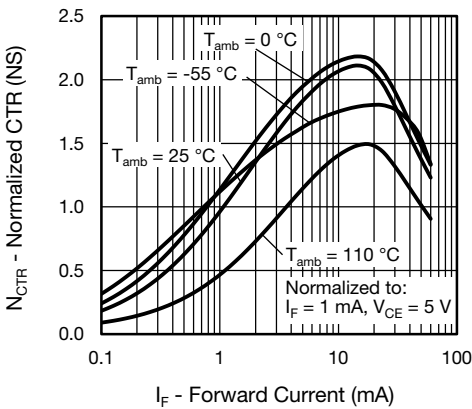


Fig. 13 - Current Transfer Ratio vs. Forward Current (non-sat.)

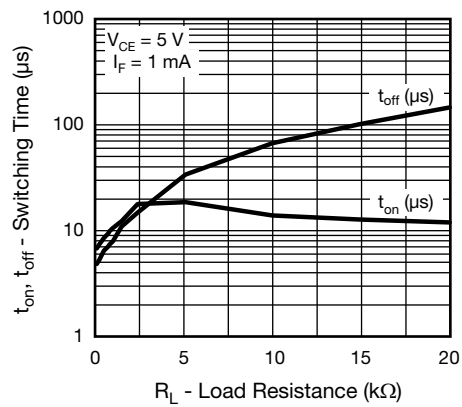


Fig. 16 - Switching Time vs. Load Resistance

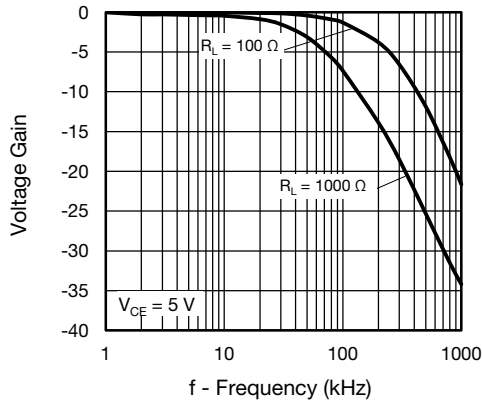
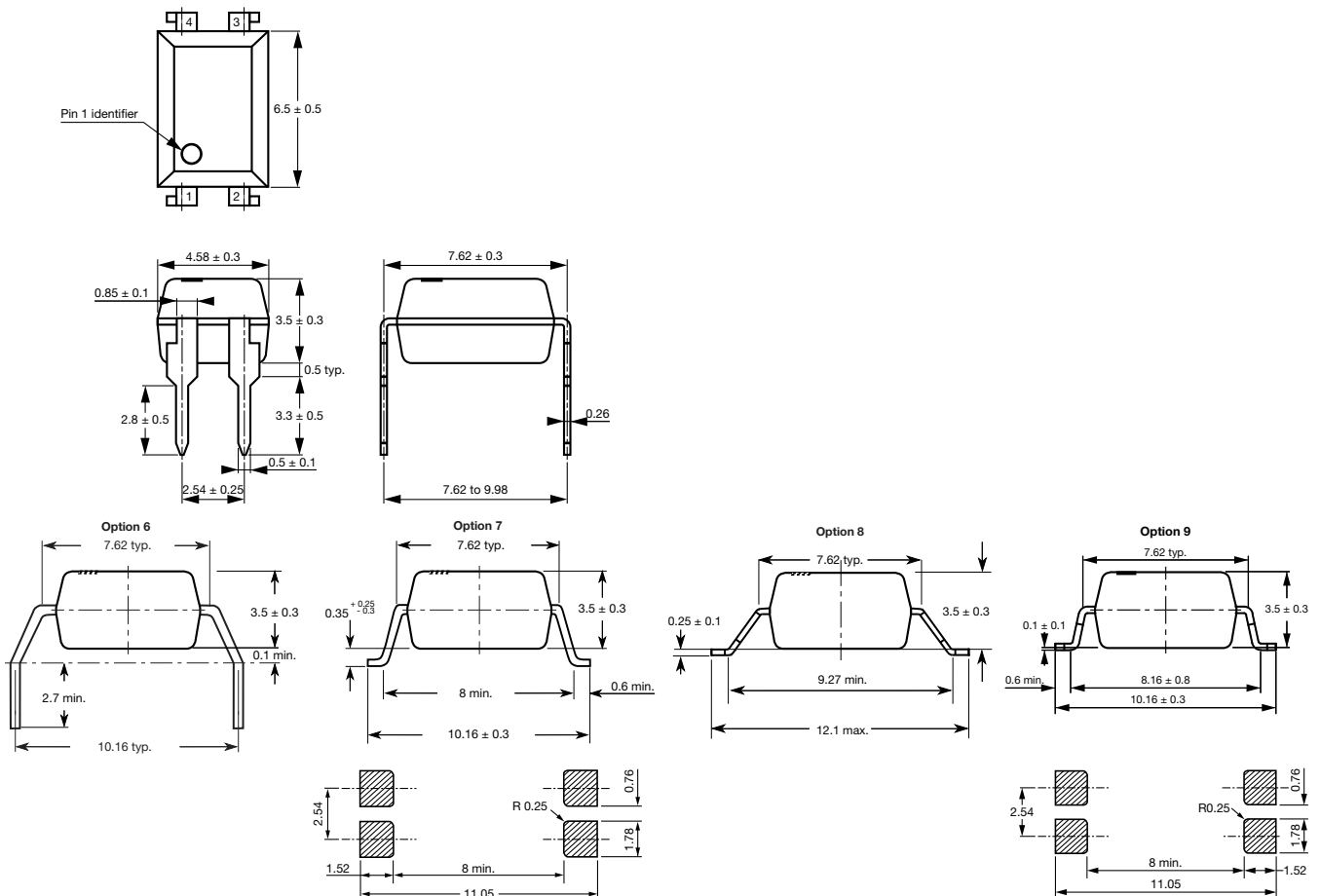
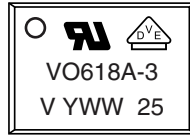


Fig. 17 - Voltage Gain vs. Frequency

**PACKAGE DIMENSIONS** in millimeters



**PACKAGE MARKING** (Example of VO618A-3X017T)



**Notes**

- The VDE logo is only marked on option 1 parts. Option information is not marked on the part.
- Tape and reel suffix (T) is not part of the package marking.

**PACKING INFORMATION**

DEVICE PER TUBE			
TYPE	UNITS/TUBE	TUBES/BOX	UNITS/BOX
DIP-4	100	40	4000

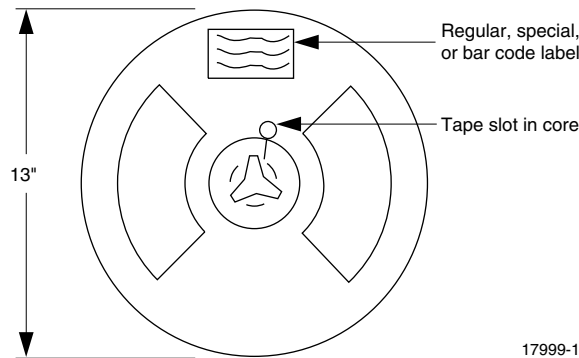


Fig. 18 - Tape and Reel Shipping Medium (1000 units per reel)

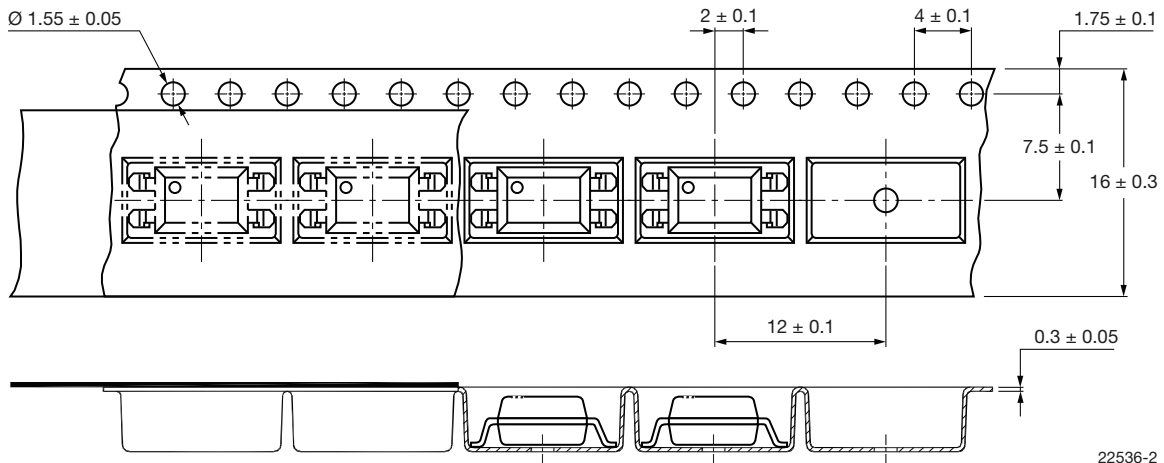


Fig. 19 - Tape and Packing for Option 7 and Option 9



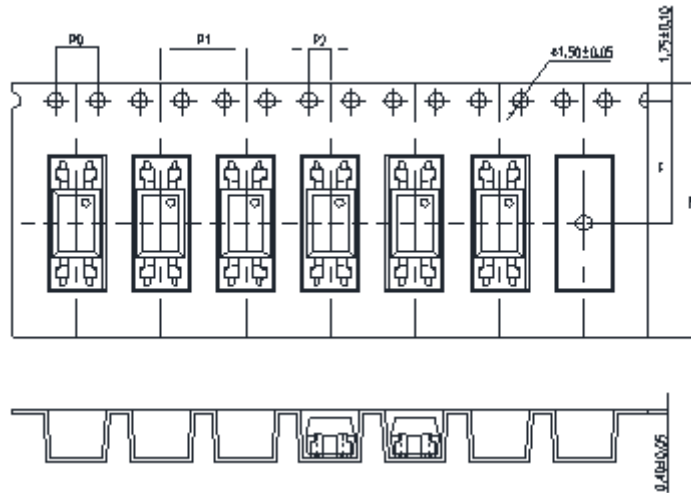
**TAPE AND REEL**
**Option 8**


Fig. 20 - Default Orientation, 2000 units/reel

DESCRIPTION	SYMBOL	DIMENSIONS in mm (inch)
Tape width	W	24 ± 0.3 (0.63)
Pitch of spocket holes	P0	4 ± 0.1 (0.15)
Distance of compartment	F	11.5 ± 0.1 (0.295)
	P2	2 ± 0.1 (0.079)
Distance of compartment to compartment	P1	8 ± 0.1 (0.472)

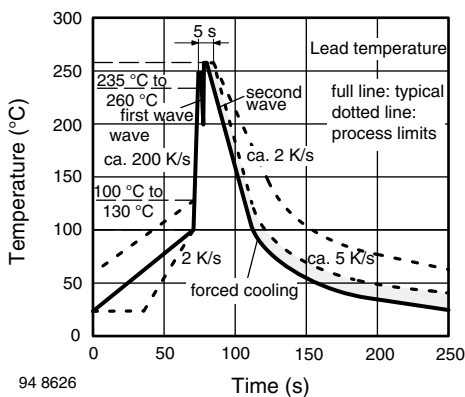
**SOLDER PROFILES**


Fig. 21 - Wave Soldering Double Wave Profile According to J-STD-020 for DIP-8 Devices

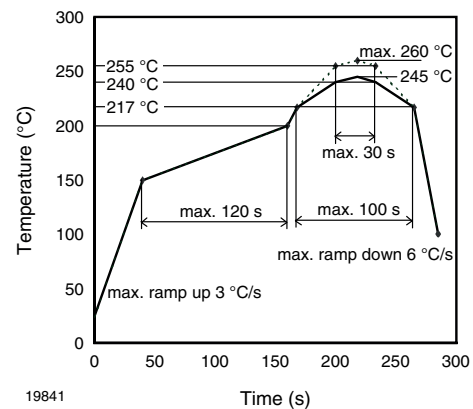


Fig. 22 - Lead (Pb)-free Reflow Solder Profile According to J-STD-020 for SMD-8 Devices

**HANDLING AND STORAGE CONDITIONS**

ESD level: HBM class 2

Floor life: unlimited

 Conditions:  $T_{amb} < 30\text{ }^{\circ}\text{C}$ , RH < 85 %

Moisture sensitivity level 1, according to J-STD-020



## **Disclaimer**

ALL PRODUCT, PRODUCT SPECIFICATIONS AND DATA ARE SUBJECT TO CHANGE WITHOUT NOTICE TO IMPROVE RELIABILITY, FUNCTION OR DESIGN OR OTHERWISE.

Vishay Intertechnology, Inc., its affiliates, agents, and employees, and all persons acting on its or their behalf (collectively, "Vishay"), disclaim any and all liability for any errors, inaccuracies or incompleteness contained in any datasheet or in any other disclosure relating to any product.

Vishay makes no warranty, representation or guarantee regarding the suitability of the products for any particular purpose or the continuing production of any product. To the maximum extent permitted by applicable law, Vishay disclaims (i) any and all liability arising out of the application or use of any product, (ii) any and all liability, including without limitation special, consequential or incidental damages, and (iii) any and all implied warranties, including warranties of fitness for particular purpose, non-infringement and merchantability.

Statements regarding the suitability of products for certain types of applications are based on Vishay's knowledge of typical requirements that are often placed on Vishay products in generic applications. Such statements are not binding statements about the suitability of products for a particular application. It is the customer's responsibility to validate that a particular product with the properties described in the product specification is suitable for use in a particular application. Parameters provided in datasheets and / or specifications may vary in different applications and performance may vary over time. All operating parameters, including typical parameters, must be validated for each customer application by the customer's technical experts. Product specifications do not expand or otherwise modify Vishay's terms and conditions of purchase, including but not limited to the warranty expressed therein.

Except as expressly indicated in writing, Vishay products are not designed for use in medical, life-saving, or life-sustaining applications or for any other application in which the failure of the Vishay product could result in personal injury or death. Customers using or selling Vishay products not expressly indicated for use in such applications do so at their own risk. Please contact authorized Vishay personnel to obtain written terms and conditions regarding products designed for such applications.

No license, express or implied, by estoppel or otherwise, to any intellectual property rights is granted by this document or by any conduct of Vishay. Product names and markings noted herein may be trademarks of their respective owners.