

IEC Appliance Outlet J, Snap-in Mounting, Front Side, IDC Terminal, integrated Light Pipe, Color Coding



Arrangement "along", white  
 (wires along to pin axis)



Arrangement "cross", grey  
 (wires cross to pin axis)



Arrangement "cross", black  
 (wires cross to pin axis)

Order required accessories separately

type J



70° C

See below:

[Approvals and Compliances](#)

**Description**

- Panel mount :  
 Snap-in version , from front side
- Connector , Pin temperature 70 °C , Protection class I
- Wire gauge 10AWG/6.0mm<sup>2</sup>, 12AWG/4.0mm<sup>2</sup>, 2.5mm<sup>2</sup>
- Light Pipe as an accessory, has to be ordered seperately
- Live contact as PCB terminal
- Protection cover can be used as wire press
- IDC terminals acc. to IEC 60998-2-3 for solid wires

**Unique Selling Proposition**

- Reduces labor costs
- Allows wiring of multiple terminals at once
- Light pipe for status indication
- V-Lock cord retaining standard

The integration of light pipes in the appliance outlet provides status indication in smart PDUs. See PDU Landing Page for more information.

[Power Distribution Units](#)

**Other versions on request**

- Other panel thickness
- Live contact also available as IDC, solder or quick connect terminal
- Samples available in grey and white

**References**

Alternative: version for 10 A (15 A) [6610-5](#)  
 Alternative: version without light pipe [4710](#)

**Weblinks**

[pdf datasheet](#), [html-datasheet](#), [General Product Information](#), [Distributor-Stock-Check](#), [Accessories](#), [Mounting instruction](#), [Detailed request for product](#), [Microsite](#), [Landing Page](#), [Video](#)

**Technical Data**

Ratings IEC	16 A / 250 VAC; 50 Hz	appliance inlet/-outlet	type J acc. to IEC 60320-3
Ratings UL/CSA	20 A / 250 VAC; 60 Hz		UL 60320-1, CSA C22.2 no. 60320-1
Dielectric Strength	> 2.5 kVAC between L-N > 1.5 kVAC between L/N-PE (1 min/50 Hz)		(for cold conditions) pin-temperature 70 °C, Protection Class I
Allowable Operation Temperature	-25 °C to 70 °C		
Insulation cover	Suitable for appliances with protection class I acc. to IEC 61140		
Terminal	IDC terminals		
Panel Thickness S	1/1.2/1.5/2/2.5/3 mm		
Material: Housing	Thermoplastic, UL 94V-0		

**Approvals and Compliances**

Detailed information on product approvals, code requirements, usage instructions and detailed test conditions can be looked up in [Details about Approvals](#)

**Approvals**





The approval mark is used by the testing authorities to certify compliance with the safety requirements placed on electronic products.

Approval Reference Type: 4710-5

Approval Logo	Certificates	Certification Body	Description
	VDE Approvals	VDE	Certificate Number: 40042639
	UL Approvals	UL	UL File Number: E103791
	CQC Approvals	CQC	CCC Certificate Number: 2018180204005080

**Product standards**

Product standards that are referenced

Organization	Design	Standard	Description
	Designed according to	IEC 60320-1	Appliance couplers for household and similar general purposes
	Designed according to	IEC 60320-3	Appliance couplers for household and similar general purposes
	Designed according to	UL 60320-1	Standard for Attachment Plugs and Receptacles
	Designed according to	CSA C22.2 no. 60320-1	General Use Receptacles, Attachment Plugs, and Similar Wiring Devices





## Application standards

Application standards where the product can be used

Organization	Design	Standard	Description
	Designed for applications acc.	IEC/UL 60950	IEC 60950-1 includes the basic requirements for the safety of information technology equipment.

## Compliances

The product complies with following Guide Lines

Identification	Details	Initiator	Description
	RoHS	SCHURTER AG	EU Directive RoHS 2011/65/EU
	China RoHS	SCHURTER AG	The law SJ / T 11363-2006 (China RoHS) has been in force since 1 March 2007. It is similar to the EU directive RoHS.
	Halogen Free	SCHURTER AG	SCHURTER strives to offer our customers halogen free products.
	REACH	SCHURTER AG	On 1 June 2007, Regulation (EC) No 1907/2006 on the Registration, Evaluation, Authorization and Restriction of Chemicals 1 (abbreviated as "REACH") entered into force.
		SCHURTER AG	V-Lock system are based on a matching plug-dose combination. The connector is equipped with a notch intended for use with the latching cordset. The cord latching system prevents against accidental removal of the cordset.

## Dimensions [mm]

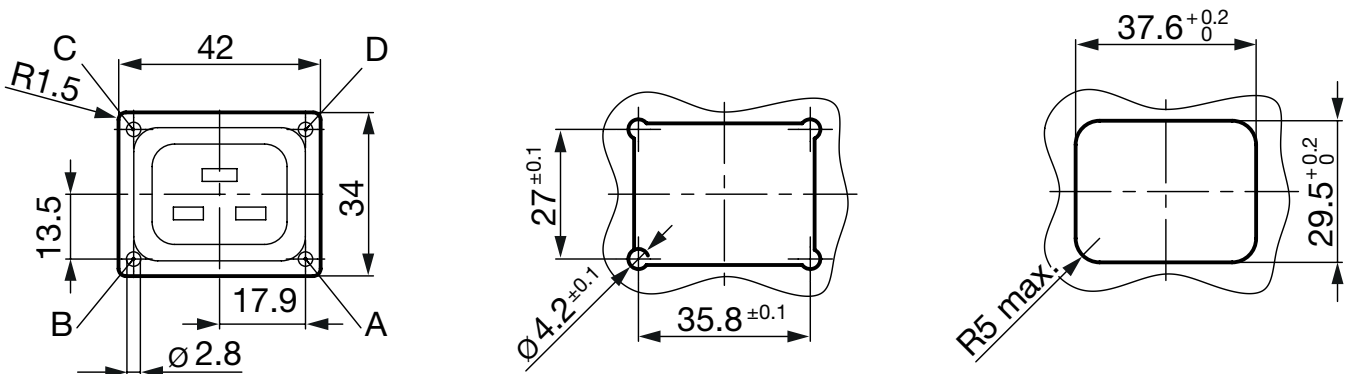

Version "along" (wires along to pin axis)

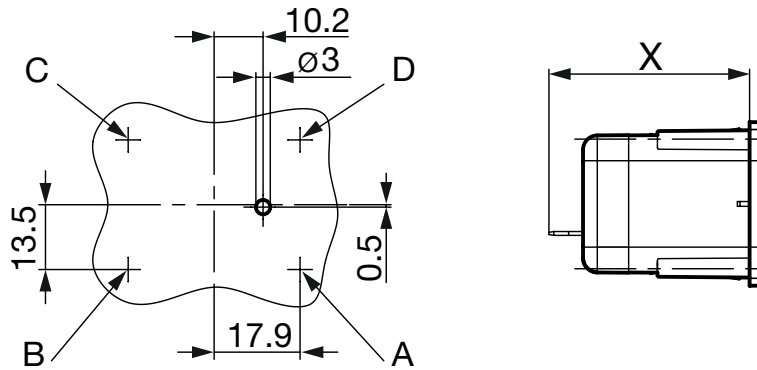

Length X in mm

Solder terminal	44.1
Quick-connect terminal	43.7
PCB terminal	41.8

Version "cross" (wires cross to pin axis)

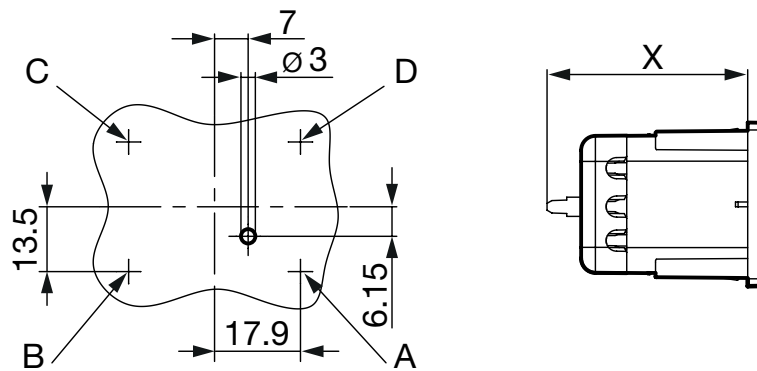

Length X in mm

Solder terminal	41.7
Quick-connect terminal	43.7
PCB terminal	41.8

**Assembly Instructions**

Wire press version "cross"

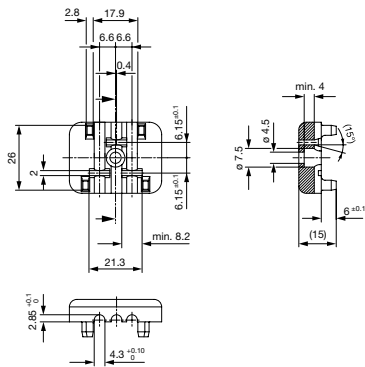

Wire press version "along"

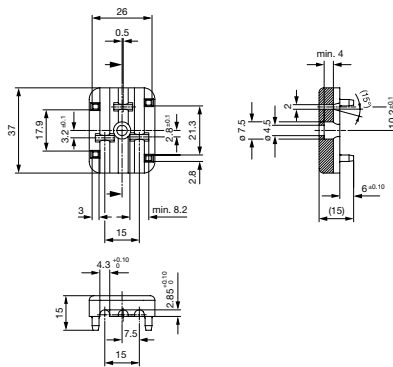

- Please see the mounting instructions for a more detailed description of the assembly. [Mounting instruction](#)
- You can find the CAD files for wire press tools in the downloads. [CAD-Drawings](#)

**All Variants**

Alignment 1)	Terminal type live contact	Conductor cross section	Panel Thickness [mm]	Light Pipe Position - A	Light Pipe Position - B	Light Pipe Position - C	Light Pipe Position - D	Color	Order Number
along	PCB terminals	2.5 mm <sup>2</sup>	1.5		●	●		black	<a href="#">3-110-012</a>
along	PCB terminals	4.0 mm <sup>2</sup> / 12 AWG	1.5		●	●		black	<a href="#">3-103-026</a>
along	PCB terminals	2.5 mm <sup>2</sup>	2.0		●	●		black	<a href="#">3-110-013</a>
along	PCB terminals	4.0 mm <sup>2</sup> / 12 AWG	2.0		●	●		black	<a href="#">3-110-014</a>
cross	PCB terminals	2.5 mm <sup>2</sup>	1.5			●	●	black	<a href="#">3-110-015</a>
cross	PCB terminals	4.0 mm <sup>2</sup> / 12 AWG	1.5			●	●	black	<a href="#">3-110-016</a>
cross	PCB terminals	2.5 mm <sup>2</sup>	2.0			●	●	black	<a href="#">3-110-020</a>
cross	PCB terminals	4.0 mm <sup>2</sup> / 12 AWG	2.0			●	●	black	<a href="#">3-110-021</a>

Most Popular:

Availability for all products can be searched real-time: <https://www.schurter.com/en/Stock-Check/Stock-Check-SCHURTER>

1) The alignment describes whether the wires are along or across to the connector pin axis.

**Packaging unit** 50 Pcs

**Required Accessory**

Description



Light Pipe  
 Transparent Plexiglas Light Pipe

### Mating Inlets/Plugs

Category / Description



[Plug Overview complete](#)

IEC Plug I, Cord Connector (Rewireable), Straight	4796
IEC Plug I, Cord Connector (Rewireable), Angled	4789

[Plug further types to 4710-5](#)

### Mating Inlets/Plugs shuttered



[Interconnection Cord Overview complete](#)

VAC19KS, Interconnection, V-Lock cord retaining, 2.0 m, Connector IEC C19, H05VV-F3G1.5 / SJT 3x14 AWG, black	3-100-362
VAC19KS, Interconnection, V-Lock cord retaining, 3.0 m, Connector IEC C19, H05VV-F3G1.5 / SJT 3x14 AWG, black	3-100-363
VAC19KS, Interconnection, V-Lock cord retaining, 1.0 m, Connector IEC C19, H05VV-F3G1.5, black	6051.2147
VAC19KS, Interconnection, V-Lock cord retaining, 1.0 m, Connector IEC C19, H05VV-F3G1.5 / SJT 3x14 AWG, black	6051.2197
VAC19KS, Interconnection, V-Lock cord retaining, 2.0 m, Connector IEC C19, H05VV-F3G1.5, black	6051.2047

[Interconnection Cord further types to 4710-5](#)